

SOT-23 Plastic-Encapsulate Diodes

BAT54/A/C/S SCHOTTKY BARRIER DIODE

FEATURES

- Extremely Fast Switching Speed

SOT-23

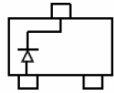
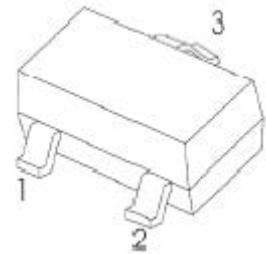

BAT54 MARKING: KL1

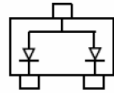

BAT54A MARKING: KL2

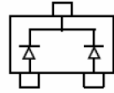



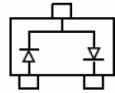

BAT54C MARKING: KL3



BAT54S MARKING: KL4

MARKING:

BAT54	BAT54A	BAT54C	BAT54S
			

Solid dot = Green molding compound device.

MAXIMUM RATINGS ($T_a=25^\circ\text{C}$ unless otherwise noted)

Parameter	Symbol	Value	Unit
Peak Repetitive Reverse Voltage	V_{RRM}	30	V
Working Peak Reverse Voltage	V_{RWM}		
DC Blocking Voltage	V_R		
Forward Continuous Current	I_{FM}	200	mA
Non-repetitive Peak Forward Surge Current @ $t=8.3\text{ms}$	I_{FSM}	600	mA
Repetitive Peak Forward Current @ $t \leq 1\text{s}, \delta \leq 0.5$	I_{FRM}	300	mA
Power Dissipation	P_D	200	mW
Thermal Resistance from Junction to Ambient	$R_{\theta JA}$	500	$^\circ\text{C}/\text{W}$
Operating Junction Temperature Range	T_j	-40 ~ +125	$^\circ\text{C}$
Storage Temperature Range	T_{stg}	-55 ~ +150	$^\circ\text{C}$

ELECTRICAL CHARACTERISTICS($T_a=25^\circ\text{C}$ unless otherwise specified)

Parameter	Symbol	Min	Typ	Max	Unit	Test conditions
Reverse voltage	$V_{(BR)}$	30			V	$I_R=100\mu\text{A}$
Forward voltage	V_F			0.24	V	$I_{F1}=0.1\text{mA}$
				0.32	V	$I_{F2}=1\text{mA}$
				0.40	V	$I_{F3}=10\text{mA}$
				0.50	V	$I_{F4}=30\text{mA}$
				1	V	$I_{F5}=100\text{mA}$
Reverse current	I_R			2	μA	$V_R=25\text{V}$
Diode capacitance	C_D			10	pF	$V_R=1\text{V}, f=1\text{MHz}$
Reverse recovery time	t_{rr}			5	ns	$I_F=I_R=10\text{mA}$ $I_{rr}=0.1 \times I_R, R_L=100\Omega$

Typical Characteristics

Forward Characteristics

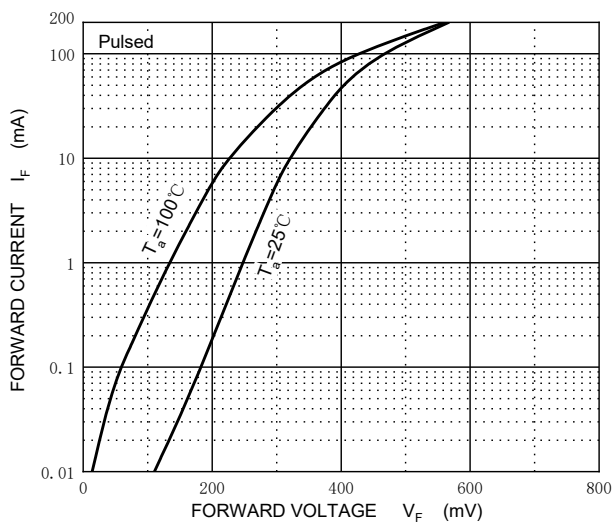

Reverse Characteristics

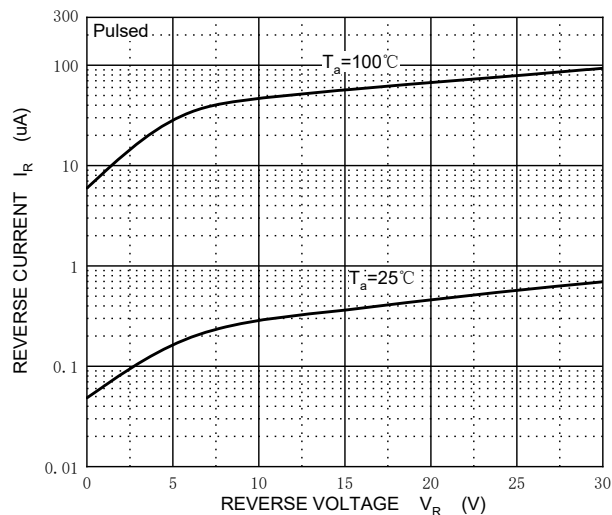

Capacitance Characteristics

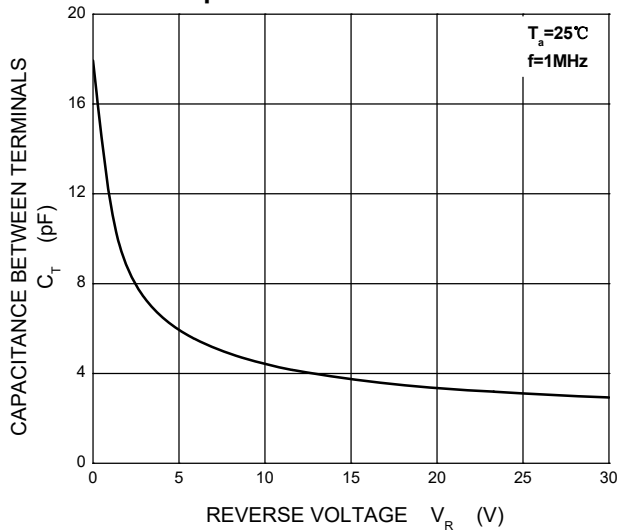

Power Derating Curve

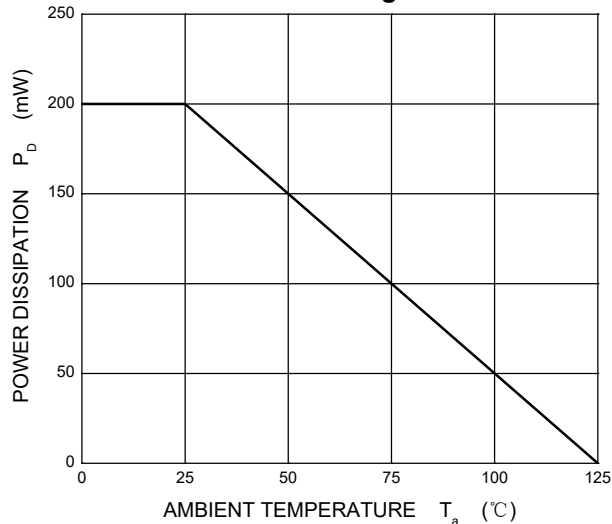

SOT-23 Package Outline Dimensions

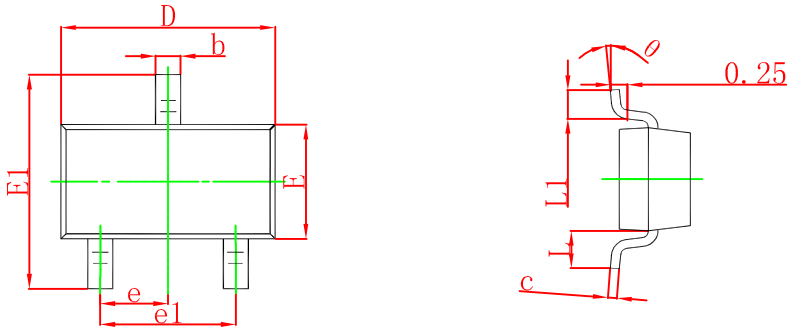

Symbol	Dimensions In Millimeters		Dimensions In Inches	
	Min	Max	Min	Max
A	0.900	1.150	0.035	0.045
A1	0.000	0.100	0.000	0.004
A2	0.900	1.050	0.035	0.041
b	0.300	0.500	0.012	0.020
c	0.080	0.150	0.003	0.006
D	2.800	3.000	0.110	0.118
E	1.200	1.400	0.047	0.055
E1	2.250	2.550	0.089	0.100
e	0.950 TYP		0.037 TYP	
e1	1.800	2.000	0.071	0.079
L	0.550 REF		0.022 REF	
L1	0.300	0.500	0.012	0.020
θ	0°	8°	0°	8°

SOT-23 Suggested Pad Layout



Note:

1. Controlling dimension: in millimeters.
2. General tolerance: $\pm 0.05\text{mm}$.
3. The pad layout is for reference purposes only.

NOTICE

JSCJ reserves the right to make modifications, enhancements, improvements, corrections or other changes without further notice to any product herein. JSCJ does not assume any liability arising out of the application or use of any product described herein.

SOT-23 Tape and Reel

SOT-23 Embossed Carrier Tape

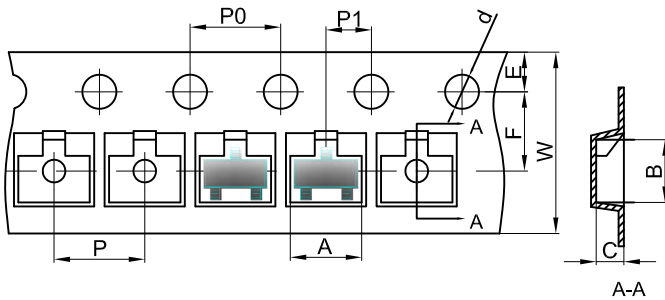

Packaging Description:

SOT-23 parts are shipped in tape. The carrier tape is made from a dissipative (carbon filled) polycarbonate resin. The cover tape is a multilayer film (Heat Activated Adhesive in nature) primarily composed of polyester film, adhesive layer, sealant, and anti-static sprayed agent. These reeled parts in standard option are shipped with 3,000 units per 7" or 17.8cm diameter reel. The reels are clear in color and is made of polystyrene plastic (anti-static coated).

Dimensions are in millimeter

Pkg type	A	B	C	d	E	F	P0	P	P1	W
SOT-23	3.15	2.77	1.22	Ø1.50	1.75	3.50	4.00	4.00	2.00	8.00

SOT-23 Tape Leader and Trailer

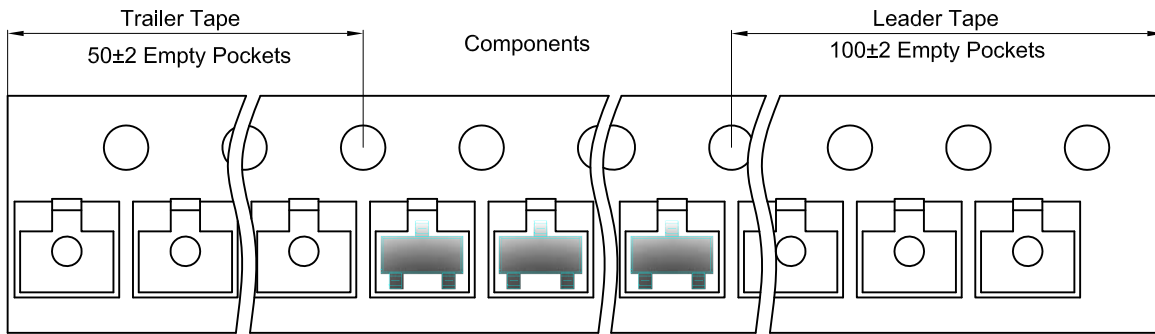

SOT-23 Reel

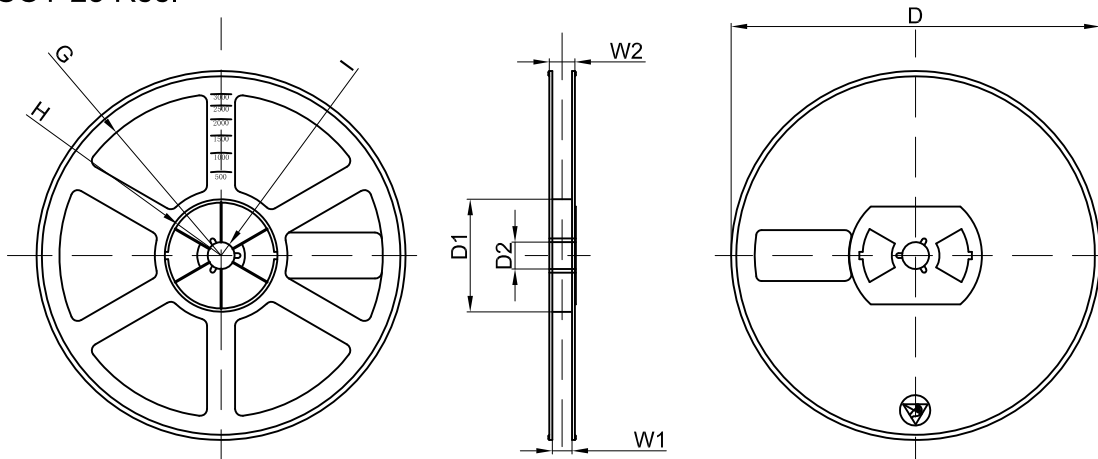

Dimensions are in millimeter

Reel Option	D	D1	D2	G	H	I	W1	W2
7"Dia	Ø178.00	54.40	13.00	R78.00	R25.60	R6.50	9.50	12.30

REEL	Reel Size	Box	Box Size(mm)	Carton	Carton Size(mm)	G.W.(kg)
3000 pcs	7 inch	45,000 pcs	203×203×195	180,000 pcs	438×438×220	