

CHIP COIL (CHIP INDUCTORS) LQW18AN□□□□0ZD
Murata Standard Reference Specification 【AEC-Q200】

1. Scope

This reference specification applies to LQW18AN_0ZD series, Chip coil (Chip Inductors) for automotive Electronics based on AEC-Q200 except for Power train and Safety.

2. Part Numbering

(ex) LQ W 18 A N 2N2 D 0 Z D
 Product ID Structure Dimension Applications Category Inductance Tolerance Features Application Packaging
 (L×W) and Characteristics Z:Automotive D:Taping

3. Rating

- Operating Temperature Range -55°C to +125°C
- Storage Temperature Range. -55°C to +125°C

Customer Part Number	MURATA Part Number	Inductance		Q (*1) (min.)	DC Resistance (*1) (Ω max.)	Self Resonant Frequency (*1) (MHz min.)	Rated Current (mA)	ESD Rank 6: 25kV				
		(nH)	Tolerance									
	LQW18AN2N2D0ZD	2.2	D:±0.5nH	16	0.042	6000	700	6				
	LQW18AN3N6C0ZD	3.6	C:±0.2nH D:±0.5nH	25	0.059		750					
	LQW18AN3N6D0ZD											
	LQW18AN3N9C0ZD	3.9	C:±0.2nH D:±0.5nH	35	0.082							
	LQW18AN3N9D0ZD											
	LQW18AN4N3C0ZD	4.3	C:±0.2nH D:±0.5nH	35	0.11							
	LQW18AN4N3D0ZD											
	LQW18AN4N7D0ZD	4.7	D:±0.5nH	40	0.16		650					
	LQW18AN5N6C0ZD	5.6	C:±0.2nH D:±0.5nH						6000	750		
	LQW18AN5N6D0ZD											
	LQW18AN6N2C0ZD	6.2	C:±0.2nH D:±0.5nH								6000	650
	LQW18AN6N2D0ZD											
	LQW18AN6N8C0ZD	6.8	C:±0.2nH D:±0.5nH			6000		650				
	LQW18AN6N8D0ZD											
	LQW18AN7N5C0ZD	7.5	C:±0.2nH D:±0.5nH				6000		650			
	LQW18AN7N5D0ZD											
	LQW18AN8N2C0ZD	8.2	C:±0.2nH D:±0.5nH							6000	650	
	LQW18AN8N2D0ZD											
	LQW18AN8N7C0ZD	8.7	C:±0.2nH D:±0.5nH			6000		650				
	LQW18AN8N7D0ZD											
	LQW18AN9N1C0ZD	9.1	C:±0.2nH D:±0.5nH	6000	650							
	LQW18AN9N1D0ZD											
	LQW18AN9N5D0ZD	9.5	D:±0.5nH				40		0.16	550		
	LQW18AN10NG0ZD	10	G:±2% J:±5%								5500	550
	LQW18AN10NJ0ZD											
	LQW18AN11NG0ZD	11	G:±2% J:±5%			5500		550				
	LQW18AN11NJ0ZD											
	LQW18AN12NG0ZD	12	G:±2% J:±5%	5500	550							
	LQW18AN12NJ0ZD											
	LQW18AN13NG0ZD	13	G:±2% J:±5%							5500	550	
	LQW18AN13NJ0ZD											
	LQW18AN15NG0ZD	15	G:±2% J:±5%			5500		550				
	LQW18AN15NJ0ZD											
	LQW18AN16NG0ZD	16	G:±2% J:±5%	5500	550							
	LQW18AN16NJ0ZD											

Customer Part Number	MURATA Part Number	Inductance		Q (*1) (min.)	DC Resistance (*1) (Ω max.)	Self Resonant Frequency (*1) (MHz min.)	Rated Current (mA)	ESD Rank 6: 25kV	
		(nH)	Tolerance						
	LQW18AN18NG0ZD	18	G:±2% J:±5%	40	0.16	5500	550	6	
	LQW18AN18NJ0ZD								
	LQW18AN20NG0ZD	20					4900		
	LQW18AN20NJ0ZD								
	LQW18AN22NG0ZD	22					4600		500
	LQW18AN22NJ0ZD								
	LQW18AN24NG0ZD	24					3800		500
	LQW18AN24NJ0ZD								
	LQW18AN27NG0ZD	27					3700		440
	LQW18AN27NJ0ZD								
	LQW18AN30NG0ZD	30					3300		420
	LQW18AN30NJ0ZD								
	LQW18AN33NG0ZD	33					3200		
	LQW18AN33NJ0ZD								
	LQW18AN36NG0ZD	36					2900		400
	LQW18AN36NJ0ZD								
	LQW18AN39NG0ZD	39					2800		
	LQW18AN39NJ0ZD								
	LQW18AN43NG0ZD	43					2700		380
	LQW18AN43NJ0ZD								
	LQW18AN47NG0ZD	47			2600				
	LQW18AN47NJ0ZD								
	LQW18AN51NG0ZD	51			0.33	2500	370		
	LQW18AN51NJ0ZD								
	LQW18AN56NG0ZD	56			0.35	2400	360		
	LQW18AN56NJ0ZD								
	LQW18AN62NG0ZD	62			0.51	2300	280		
	LQW18AN62NJ0ZD								
	LQW18AN68NG0ZD	68			0.38	2200	340		
	LQW18AN68NJ0ZD								
	LQW18AN72NG0ZD	72			0.56	2100	270		
	LQW18AN72NJ0ZD								
	LQW18AN75NG0ZD	75			2050				
	LQW18AN75NJ0ZD								
	LQW18AN82NG0ZD	82			0.60	2000	250		
	LQW18AN82NJ0ZD								
	LQW18AN91NG0ZD	91			0.64	1900	230		
	LQW18AN91NJ0ZD								
	LQW18ANR10G0ZD	100			0.68	1800	220		
	LQW18ANR10J0ZD								
	LQW18ANR11G0ZD	110			1.2	1700	200		
	LQW18ANR11J0ZD								
	LQW18ANR12G0ZD	120			1.3	1600	180		
	LQW18ANR12J0ZD								
	LQW18ANR13G0ZD	130			1.4	1450	170		
	LQW18ANR13J0ZD								
	LQW18ANR15G0ZD	150			1.5	1400	160		
	LQW18ANR15J0ZD								
	LQW18ANR16G0ZD	160			2.1	1350	150		
	LQW18ANR16J0ZD								

Customer Part Number	MURATA Part Number	Inductance		Q (*1) (min.)	DC Resistance (*1) (Ω max.)	Self Resonant Frequency (*1) (MHz min.)	Rated Current (mA)	ESD Rank 6: 25kV
		(nH)	Tolerance					
	LQW18ANR18G0ZD	180	G:±2% J:±5%	25	2.2	1300	140	6
	LQW18ANR18J0ZD							
	LQW18ANR20G0ZD	200			2.4	1250	120	
	LQW18ANR20J0ZD							
	LQW18ANR22G0ZD	220			2.5	1200		
	LQW18ANR22J0ZD							
	LQW18ANR27G0ZD	270		3.4	960	110		
	LQW18ANR27J0ZD							
	LQW18ANR33G0ZD	330		5.5	800	85		
	LQW18ANR33J0ZD							
	LQW18ANR39G0ZD	390	6.2	80				
	LQW18ANR39J0ZD							
	LQW18ANR47G0ZD	470	7.0	700	75			
	LQW18ANR47J0ZD							

(*1) Standard Testing Conditions

《Unless otherwise specified》

Temperature : Ordinary Temperature / 15°C to 35°C
 Humidity : Ordinary Humidity / 25%(RH) to 85%(RH)

《In case of doubt》

Temperature : 20°C±2°C
 Humidity : 60%(RH) to 70%(RH)
 Atmospheric Pressure : 86kPa to 106 kPa

4. Appearance and Dimensions

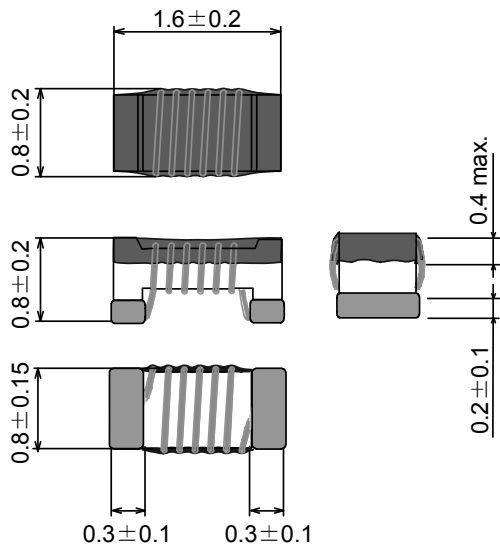

■ Unit Mass (Typical value)
 0.003g

(in mm)

5. Electrical Performance

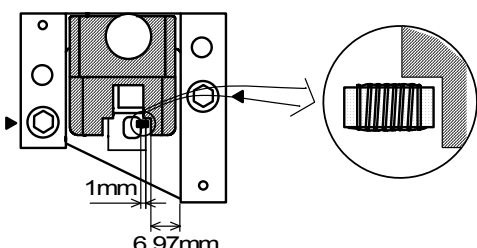
No.	Item	Specification	Test Method
5.1	Inductance	Inductance shall meet item 3.	Measuring Equipment : KEYSIGHT E4991A or equivalent Measuring Frequency : <Inductance> 100MHz <Q> 250MHz / 2.2nH~ 39nH 200MHz / 43nH~ 68nH 150MHz / 72nH~160nH 100MHz / 180nH~470nH Measuring Condition : Test signal level / about 0dBm Electrical length / 0.94cm Measuring Fixture : KEYSIGHT 16193A Position coil under test as shown in below and contact coil with each terminal by adding weight.
5.2	Q	Q shall meet item 3.	 Measuring Method : See the endnote. <Electrical Performance : Measuring Method of Inductance / Q>
5.3	DC Resistance	DC Resistance shall meet item 3.	Measuring Equipment : Digital multi meter
5.4	Self Resonant Frequency (S.R.F)	S.R.F shall meet item 3.	Measuring Equipment : KEYSIGHT N5230A or equivalent
5.5	Rated Current	Self temperature rise shall be limited to 20°C max. Inductance Change : within ±10%	The rated current is applied.

6. Q200 Requirement

6.1.Performance (based on Table 5 for Magnetics(Inductors / Transformer)

AEC-Q200 Rev.D issued June 1. 2010

AEC-Q200			Murata Specification / Deviation					
No	Stress	Test Method						
3	High Temperature Exposure	1000hours at 125 deg C Set for 24hours at room temperature, then measured.	Meet Table A after testing. Table A	<table border="1"> <tr> <td>Appearance</td> <td>No damage</td> </tr> <tr> <td>Inductance change (at 100MHz)</td> <td>Within ±5%</td> </tr> </table>	Appearance	No damage	Inductance change (at 100MHz)	Within ±5%
Appearance	No damage							
Inductance change (at 100MHz)	Within ±5%							
4	Temperature Cycling	1000cycles -40 deg C to +125 deg C Set for 24hours at room temperature, then measured.	Meet Table A after testing.					
7	Biased Humidity	1000hours at 85 deg C, 85%RH unpowered.	Meet Table A after testing.					
8	Operational Life	Apply Rated Current 125 deg C 1000hours Set for 24hours at room temperature, then measured	Meet Table A after testing.					
9	External Visual	Visual inspection	No abnormalities					

AEC-Q200			Murata Specification / Deviation				
No	Stress	Test Method					
10	Physical Dimension	Meet ITEM 4 (Style and Dimensions)	No defects				
12	Resistance to Solvents	Per MIL-STD-202 Method 215	Not Applicable				
13	Mechanical Shock	Per MIL-STD-202 Method 213 Condition C : 100g's(0.98N), 6ms, Half sine, 12.3ft / s	Meet Table A after testing.				
14	Vibration	5g's(0.049N) for 20 minutes, 12cycles each of 3 orientations Test from 10-2000Hz.	Meet Table A after testing.				
15	Resistance to Soldering Heat	No-heating Solder temperature 260C+ / -5 deg C Immersion time 10s	Pre-heating : 150C + / -10 deg C, 60s to 90s Meet Table A after testing.				
17	ESD	Per AEC-Q200-002	ESD Rank : Refer to Item 3. Rating. Meet Table A after testing.				
18	Solderability	Per J-STD-002	Method b : Not Applicable 95% of the terminations is to be soldered. (Except exposed wire)				
19	Electrical Characterization	Measured : Inductance	No defects				
20	Flammability	Per UL-94	Not Applicable				
21	Board Flex	Epoxy-PCB(1.6mm) Deflection 2mm(min) Holding time 60s	Meet Table B after testing. <table border="1"> <tr> <td>Appearance</td> <td>No damage</td> </tr> <tr> <td>DC resistance change</td> <td>Within ±10%</td> </tr> </table>	Appearance	No damage	DC resistance change	Within ±10%
Appearance	No damage						
DC resistance change	Within ±10%						
22	Terminal Strength	Per AEC-Q200-006 A force of 17.7N for 60s	Murata Deviation Request : 10N / 5s No defect				

7. Specification of Packaging

7.1 Appearance and Dimensions of paper tape (8mm-wide)

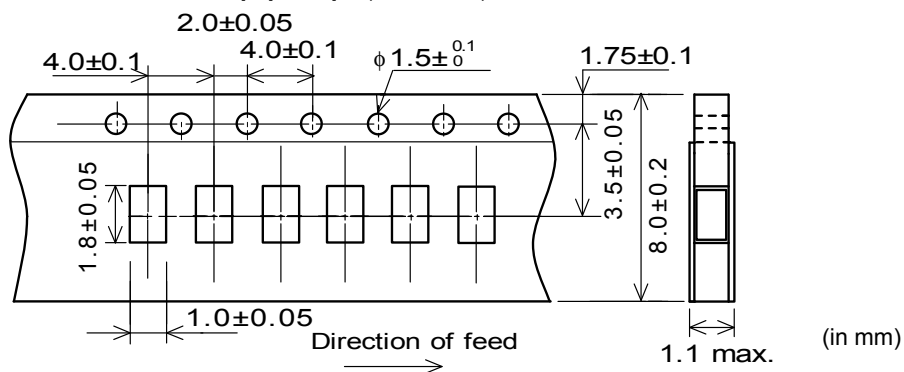

7.8 Specification of Outer Case

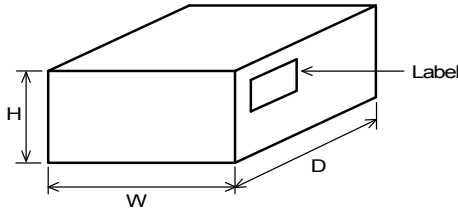

Outer Case Dimensions (mm)			Standard Reel Quantity in Outer Case (Reel)
W	D	H	
186	186	93	5

* Above Outer Case size is typical. It depends on a quantity of an order.

8. **⚠ Caution**

8.1 Limitation of Applications

Please contact us before using our products for the applications listed below which require especially high reliability for the prevention of defects which might directly cause damage to the third party's life, body or property.

- | | |
|-----------------------------------|------------------------------------------------------------------------------------------------------------------|
| (1) Aircraft equipment | (6) Transportation equipment (trains, ships, etc.) |
| (2) Aerospace equipment | (7) Traffic signal equipment |
| (3) Undersea equipment | (8) Disaster prevention / crime prevention equipment |
| (4) Power plant control equipment | (9) Data-processing equipment |
| (5) Medical equipment | (10) Applications of similar complexity and /or reliability requirements to the applications listed in the above |

8.2 Caution(Rating)

Do not exceed maximum rated current of the product. Thermal stress may be transmitted to the product and short / open circuit of the product or falling off the product may be occurred.

8.3 Fail-safe

Be sure to provide an appropriate fail-safe function on your product to prevent a second damage that may be caused by the abnormal function or the failure of our product.

9. Notice

Products can only be soldered with reflow.
 This product is designed for solder mounting.
 Please consult us in advance for applying other mounting method such as conductive adhesive.

9.1 Land pattern designing

Recommended land patterns for reflow soldering are as follows :
 These have been designed for Electric characteristics and solderability.
 Please follow the recommended patterns. Otherwise, their performance which includes electrical performance or solderability may be affected, or result to "position shift" in soldering process.

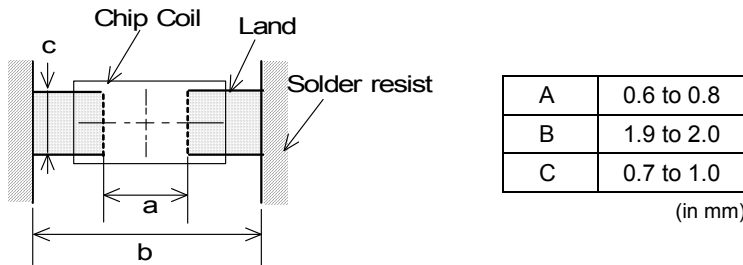

9.2 Flux, Solder

- Use rosin-based flux.
 Includes middle activator equivalent to 0.06(wt)% to 0.1(wt)% Chlorine.
 Don't use highly acidic flux with halide content exceeding 0.2(wt)% (chlorine conversion value).
 Don't use water-soluble flux.
- Use Sn-3.0Ag-0.5Cu solder.
- Standard thickness of solder paste : 100 μ m to 150 μ m.

9.3 Reflow soldering conditions

- Pre-heating should be in such a way that the temperature difference between solder and product surface is limited to 150°C max. Cooling into solvent after soldering also should be in such a way that the temperature difference is limited to 100°C max.
Insufficient pre-heating may cause cracks on the product, resulting in the deterioration of products quality.
- Standard soldering profile and the limit soldering profile is as follows.
The excessive limit soldering conditions may cause leaching of the electrode and / or resulting in the deterioration of product quality.
- Reflow soldering profile

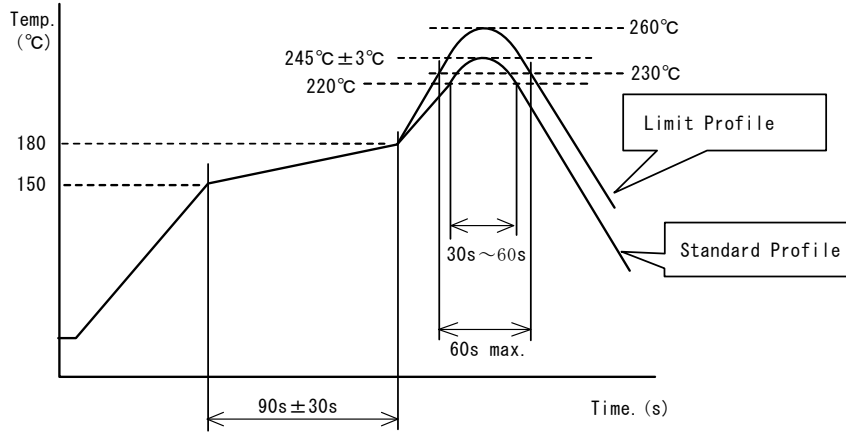

	Standard Profile	Limit Profile
Pre-heating	150°C~180°C , 90s±30s	
Heating	above 220°C, 30s~60s	above 230°C, 60s max.
Peak temperature	245°C±3°C	260°C, 10s
Cycle of reflow	2 times	2 times

9.4 Reworking with soldering iron

The following conditions must be strictly followed when using a soldering iron.

Pre-heating	150°C, 1 min
Tip temperature	350°C max.
Soldering iron output	80W max.
Tip diameter	φ3mm max.
Soldering time	3(+1,-0)s
Time	2 times

Note : Do not directly touch the products with the tip of the soldering iron in order to prevent the crack on the products due to the thermal shock.

9.5 Solder Volume

- Solder shall be used not to be exceed the upper limits as shown below.
- Accordingly increasing the solder volume, the mechanical stress to Chip is also increased. Exceeding solder volume may cause the failure of mechanical or electrical performance.

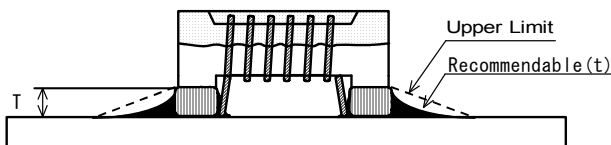

$1/3T \leq t \leq T$
 T : thickness of product

9.6 Product's location

The following shall be considered when designing and laying out P.C.B.'s.

- (1) P.C.B. shall be designed so that products are not subject to the mechanical stress due to warping the board.

[Products direction]

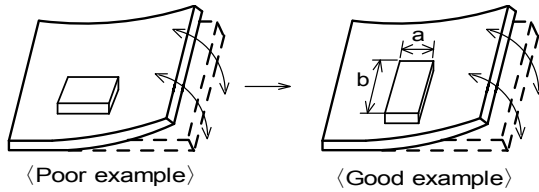

Products shall be located in the sideways direction (Length:a<b) to the mechanical stress.

- (2) Components location on P.C.B. separation.

It is effective to implement the following measures, to reduce stress in separating the board.

It is best to implement all of the following three measures; however, implement as many measures as possible to reduce stress.

Contents of Measures	Stress Level
(1) Turn the mounting direction of the component parallel to the board separation surface.	A > D *1
(2) Add slits in the board separation part.	A > B
(3) Keep the mounting position of the component away from the board separation surface.	A > C

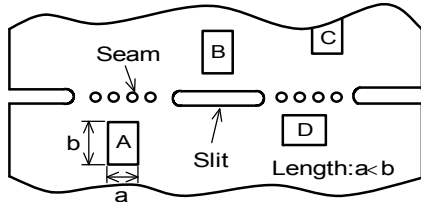

*1 A > D is valid when stress is added vertically to the perforation as with Hand Separation. If a Cutting Disc is used, stress will be diagonal to the PCB, therefore A > D is invalid.

- (3) Mounting Components Near Screw Holes

When a component is mounted near a screw hole, it may be affected by the board deflection that occurs during the tightening of the screw. Mount the component in a position as far away from the screw holes as possible.

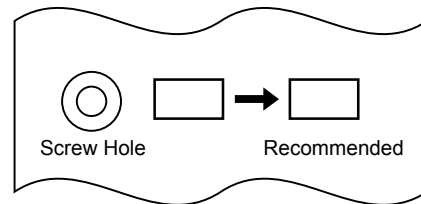

9.7 Cleaning Conditions

Products shall be cleaned on the following conditions.

- (1) Cleaning temperature shall be limited to 60°C max. (40°C max for IPA)
- (2) Ultrasonic cleaning shall comply with the following conditions with avoiding the resonance phenomenon at the mounted products and P.C.B.

Power : 20 W / l max. Frequency : 28kHz to 40kHz Time : 5 min max.

- (3) Cleaner

1. Alcohol type cleaner
Isopropyl alcohol (IPA)
2. Aqueous agent
PINE ALPHA ST-100S

- (4) There shall be no residual flux and residual cleaner after cleaning.

In the case of using aqueous agent, products shall be dried completely after rinse with de-ionized water in order to remove the cleaner.

- (5) Other cleaning Please contact us.

9.8 Resin coating

The inductance value may change due to high cure-stress of resin to be used for coating/molding products.

An open circuit issue may occur by mechanical stress caused by the resin, amount/cured shape of resin, or operating condition etc. Some resin contains some impurities or chloride possible to generate chlorine by hydrolysis under some operating condition may cause corrosion of wire of coil, leading to open circuit.

So, please pay your careful attention when you select resin in case of coating/molding the products with the resin.

Prior to use the coating resin, please make sure no reliability issue is observed by evaluating products mounted on your board.

9.9 Caution for use

- Sharp material such as a pair of tweezers or other material such as bristles of cleaning brush , shall not be touched to the winding portion to prevent the breaking of wire.
- Mechanical shock should not be applied to the products mounted on the board to prevent the breaking of the core.

9.10 Notice of product handling at mounting

In some mounting machines, when picking up components support pin pushes up the components from the bottom of base tape. In this case, please remove the support pin. The support pin may damage the components and break wire. In rare case, the laser recognition can not recognize this component. Please contact us when you use laser recognition. (There is no problem with the permeation and reflection type.)

9.11 Handling of a substrate

After mounting products on a substrate, do not apply any stress to the product caused by bending or twisting to the substrate when cropping the substrate, inserting and removing a connector from the substrate or tightening screw to the substrate.

Excessive mechanical stress may cause cracking in the product.

Bending

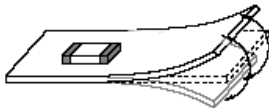

Twisting

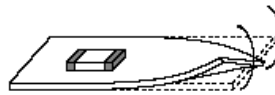
**9.12 Storage and Handling Requirements**

(1) Storage period

Use the products within 12 months after delivered.

Solderability should be checked if this period is exceeded.

(2) Storage conditions

- Products should be stored in the warehouse on the following conditions.

Temperature : -10°C to 40°C

Humidity : 15% to 85% relative humidity No rapid change on temperature and humidity

- Don't keep products in corrosive gases such as sulfur, chlorine gas or acid, or it may cause oxidization of electrode, resulting in poor solderability.
- Products should not be stored on bulk packaging condition to prevent the chipping of the core and the breaking of winding wire caused by the collision between the products.
- Products should be stored on the palette for the prevention of the influence from humidity, dust and so on.
- Products should be stored in the warehouse without heat shock, vibration, direct sunlight and so on.

(3) Handling Condition

Care should be taken when transporting or handling product to avoid excessive vibration or mechanical shock.

10. ⚠ Note

- (1) Please make sure that your product has been evaluated in view of your specifications with our product being mounted to your product.
- (2) You are requested not to use our product deviating from the reference specifications.
- (3) The contents of this reference specification are subject to change without advance notice.
Please approve our product specifications or transact the approval sheet for product specifications before ordering.

<Electrical Performance : Measuring Method of Inductance / Q>

(1) Residual elements and stray elements of test fixture can be described by F-parameter shown in following.

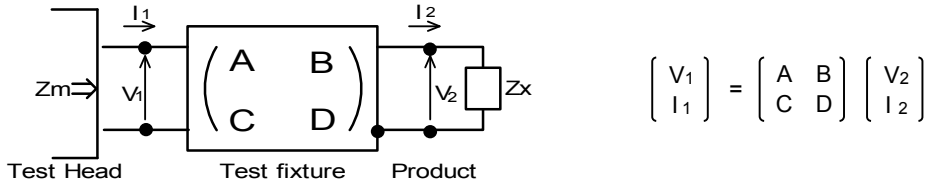

(2) The impedance of chip coil Z_x and measured value Z_m can be described by input/output current/voltage.

$$Z_m = \frac{V_1}{I_1}, \quad Z_x = \frac{V_2}{I_2}$$

(3) Thus, the relation between Z_x and Z_m is following;

$$Z_x = \alpha \frac{Z_m - \beta}{1 - Z_m \Gamma} \quad \text{where, } \alpha = D / A = 1$$

$$\beta = B / D = Z_{sm} - (1 - Y_{om} Z_{sm}) Z_{ss}$$

$$\Gamma = C / A = Y_{om}$$

- Z_{sm} : measured impedance of short chip
- Z_{ss} : residual impedance of short chip (0.771nH)
- Y_{om} : measured admittance when opening the fixture

(4) L_x and Q_x shall be calculated with the following equation.

$$L_x = \frac{\text{Im}(Z_x)}{2\pi f}, \quad Q_x = \frac{\text{Im}(Z_x)}{\text{Re}(Z_x)}$$

L_x : Inductance of chip coil
 Q_x : Q of chip coil
 f : Measuring frequency

Mouser Electronics

Authorized Distributor

Click to View Pricing, Inventory, Delivery & Lifecycle Information:

Murata:

[LQW18AN72NJ0ZD](#) [LQW18ANR16J0ZD](#) [LQW18ANR15J0ZD](#) [LQW18ANR18G0ZD](#) [LQW18AN16NJ0ZD](#)
[LQW18ANR10J0ZD](#) [LQW18AN13NG0ZD](#) [LQW18AN51NG0ZD](#) [LQW18AN4N7D0ZD](#) [LQW18AN33NJ0ZD](#)
[LQW18AN9N5D0ZD](#) [LQW18AN39NG0ZD](#) [LQW18AN68NJ0ZD](#) [LQW18AN22NG0ZD](#) [LQW18AN8N2C0ZD](#)
[LQW18AN22NJ0ZD](#) [LQW18AN10NJ0ZD](#) [LQW18AN3N6D0ZD](#) [LQW18AN16NG0ZD](#) [LQW18AN56NJ0ZD](#)
[LQW18AN82NG0ZD](#) [LQW18AN56NG0ZD](#) [LQW18AN3N9D0ZD](#) [LQW18ANR20G0ZD](#) [LQW18AN36NJ0ZD](#)
[LQW18ANR33J0ZD](#) [LQW18AN5N6D0ZD](#) [LQW18AN91NJ0ZD](#) [LQW18AN62NG0ZD](#) [LQW18AN4N3D0ZD](#)
[LQW18AN18NJ0ZD](#) [LQW18ANR27J0ZD](#) [LQW18AN91NG0ZD](#) [LQW18ANR22G0ZD](#) [LQW18AN62NJ0ZD](#)
[LQW18ANR27G0ZD](#) [LQW18ANR47J0ZD](#) [LQW18AN11NG0ZD](#) [LQW18AN75NJ0ZD](#) [LQW18AN33NG0ZD](#)
[LQW18ANR10G0ZD](#) [LQW18AN6N8C0ZD](#) [LQW18AN9N1C0ZD](#) [LQW18AN39NJ0ZD](#) [LQW18AN4N3C0ZD](#)
[LQW18AN51NJ0ZD](#) [LQW18ANR33G0ZD](#) [LQW18AN6N2C0ZD](#) [LQW18AN3N6C0ZD](#) [LQW18AN72NG0ZD](#)
[LQW18ANR13J0ZD](#) [LQW18ANR18J0ZD](#) [LQW18AN9N1D0ZD](#) [LQW18AN6N8D0ZD](#) [LQW18ANR47G0ZD](#)
[LQW18AN27NG0ZD](#) [LQW18AN24NJ0ZD](#) [LQW18AN27NJ0ZD](#) [LQW18AN43NJ0ZD](#) [LQW18AN43NG0ZD](#)
[LQW18AN30NG0ZD](#) [LQW18AN82NJ0ZD](#) [LQW18AN3N9C0ZD](#) [LQW18AN75NG0ZD](#) [LQW18AN10NG0ZD](#)
[LQW18AN30NJ0ZD](#) [LQW18AN20NJ0ZD](#) [LQW18ANR16G0ZD](#) [LQW18AN13NJ0ZD](#) [LQW18AN5N6C0ZD](#)
[LQW18ANR13G0ZD](#) [LQW18AN68NG0ZD](#) [LQW18AN47NJ0ZD](#) [LQW18ANR11J0ZD](#) [LQW18AN7N5D0ZD](#)
[LQW18AN11NJ0ZD](#) [LQW18AN36NG0ZD](#) [LQW18AN8N7C0ZD](#) [LQW18AN15NJ0ZD](#) [LQW18ANR20J0ZD](#)
[LQW18AN12NJ0ZD](#) [LQW18AN2N2D0ZD](#) [LQW18ANR11G0ZD](#) [LQW18AN18NG0ZD](#) [LQW18AN12NG0ZD](#)
[LQW18AN20NG0ZD](#) [LQW18AN8N2D0ZD](#) [LQW18ANR39G0ZD](#) [LQW18ANR22J0ZD](#) [LQW18AN15NG0ZD](#)
[LQW18AN47NG0ZD](#) [LQW18AN7N5C0ZD](#) [LQW18ANR15G0ZD](#) [LQW18AN8N7D0ZD](#) [LQW18AN24NG0ZD](#)
[LQW18ANR12J0ZD](#) [LQW18ANR12G0ZD](#) [LQW18AN6N2D0ZD](#) [LQW18ANR39J0ZD](#)