

Product Feature

- ◆ Universal Input: 85-305VAC/100-430VDC
- ◆ Package Type: 1" x 1"
- ◆ Operating temperature range: -40°C - +85°C
- ◆ Isolation voltage: 4000VAC
- ◆ High efficiency up to: 79% (Type)
- ◆ The mechanism has input undervoltage protection
- ◆ Output short circuit protection and over current protection

Selection Guide

Part No.	Input Voltage (VAC)	Out Power (W)	Out Voltage (VDC)	Out Current (mA)MAX	Full Load Efficiency % (Typ.)	Capacitive Load(μF) Max.
LD03-23B05R2	85-305	3	5	600	75	3000
LD03-23B09R2	85-305	3	9	333	77	1000
LD03-23B12R2	85-305	3	12	250	78	1000
LD03-23B15R2	85-305	3	15	200	78	680
LD03-23B24R2	85-305	3	24	125	79	220

Input Specifications

Item	Operating Conditions	Min.	Typ.	Max.	Unit
Input Voltage	AC Input	85	--	305	VAC
	DC Input	100	--	430	VDC
Input Current	110VAC	--	0.08	--	A
	230VAC	--	0.06	--	
Input Frequency		47	--	63	Hz
Fuse		1A, slow-blow, required			
Leakage Current	230VAC/50Hz	0.3mA RMS typ. 230VAC/50Hz			
Hot Plug		Unavailable			

Output Specifications

Item	Operating Conditions	Min.	Typ.	Max.	Unit
Output Voltage Accuracy	3.3V Output	--	±3	--	%
	Other put	--	±2	--	
Linear Regulation	Vin=Min. to Max. @Full Load	--	±0.5	--	
Load Regulation	0% - 100%load	--	±1.0	--	
Ripple & Noise	20MHz bandwidth, 10% - 100%load	--	60	--	mV
Temperature Coefficient		--	±0.02	--	%/°C
Stand-by Power Consumption	230VAC	--	0.1	--	W
Min. Load		0	--	--	%
Over Current Protection		110	--	--	%Io
Short-Circuit Protection		Continuous, Self-Recovery			
Hold-up Time	230VAC	--	50	--	ms

General Specifications

Item	Operating Conditions	Min.	Typ.	Max.	Unit
Isolation Voltage	Input-output, test time 1 minute, leakage current less than 5mA	4000	--	--	VAC
Insulation Resistance	Input-output, insulated voltage 500VDC	100	--	--	MΩ
Power Derating	+70°C - +85°C	3.3V	2.1	--	%°C
		Other voltages	1.3	--	
	85VAC - 100VAC	1.3	--	--	%/VAC
Operating Temperature		-40	--	+85	°C
Storage Temperature		-40	--	+85	
Storage Humidity		--	--	95	%RH
Soldering Profile	Wave-soldering	260 ± 5°C; time: 5 - 10s			
	Manual-welding	360 ± 5°C; time: 3 - 5s			
Safety Standard		IEC/UL62368-1			
Safety Class		CLASS II			
MTBF	MIL-HDBK-217F@25°C	>260,000h			

Mechanical Specification

Case Material	Black plastic, flame-retardant and heat-resistant (UL94V-0)
Package Dimensions	25.40 x 25.40 x 16.00mm
Weight	23g (Typ.)
Cooling Method	Free air convection

EMC Specifications

EMI	CE	CISPR32/EN55032 CLASS B	
	RE	CISPR32/EN55032 CLASS B	
EMS	ESD	IEC/EN61000-4-3 10V/m	perf. Criteria A
	RS	IEC/EN61000-4-4 ±4KV	perf. Criteria B
	EFT	IEC/EN61000-4-5 line to line ±1KV	perf. Criteria B
		IEC/EN61000-4-5 line to line ±2KV (Figure 2)	perf. Criteria B
	Surge	IEC/EN61000-4-6 10Vr.m.s	perf. Criteria A
CS	IEC/EN61000-4-2 Contact ±6KV/±8KV	perf. Criteria B	

Typical Characteristic Curves

Input voltage Derating Curve

Temperature Derating Curve

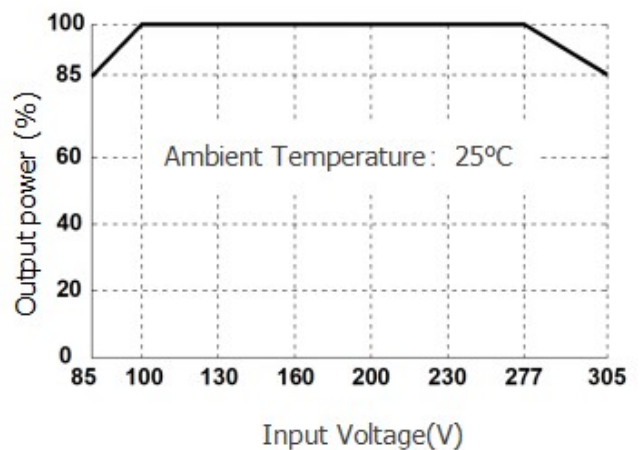
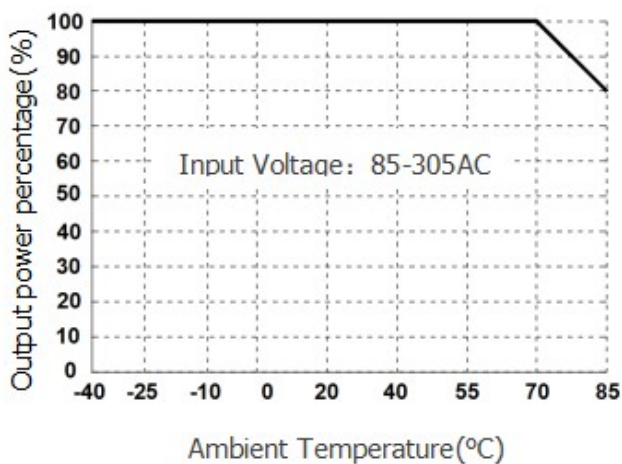

Efficiency VS input voltage (Full load)

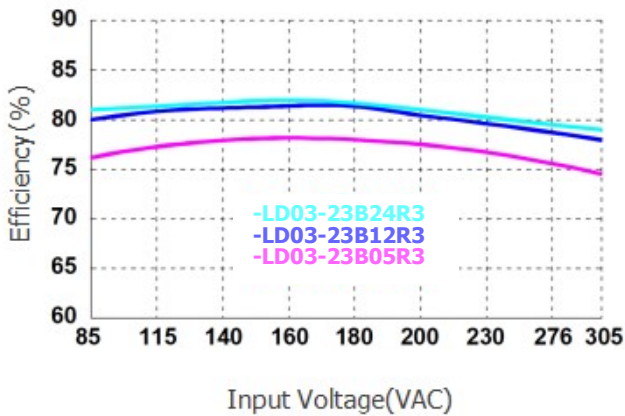

Efficiency VS out load (Vin=230VAC)

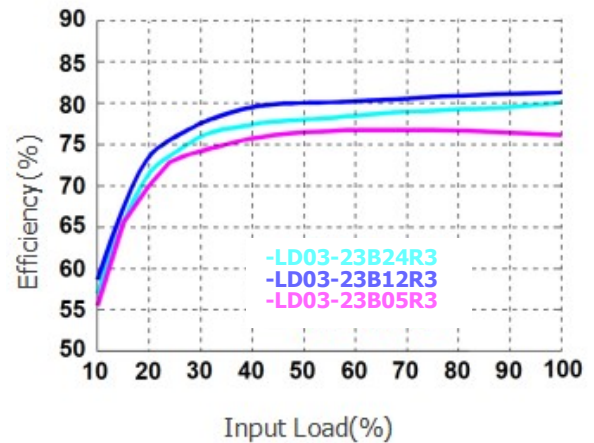

Typical Circuit Design And Application

Application circuit (Figure 1)

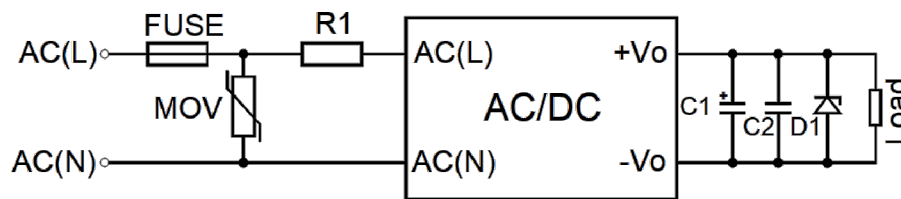

Reference Table for Selection of Peripheral Devices

Out Voltage	FUSE	MOV	R1	C1	C2	D1
5VDC	1A/300VAC	10D561K	12Ω/3W (wire-wound resistor, required)	150uF/25V	0.1uF/25V	See Note2
9/12VDC	slow-blow, required			150uF/25V	0.1uF/25V	
15/24VDC				100uF/35V	0.1uF/50V	

Note:

- Mov and NTC Can be selected based on actual needs.
- D1 is a TVS transistor that can protect the downstream circuit in case of module abnormalities. It is recommended to choose a model that is 1.2 times the output voltage.

EMS Solutions - Recommended Circuits

EMS Solutions - Recommended Circuits (Figure 2)

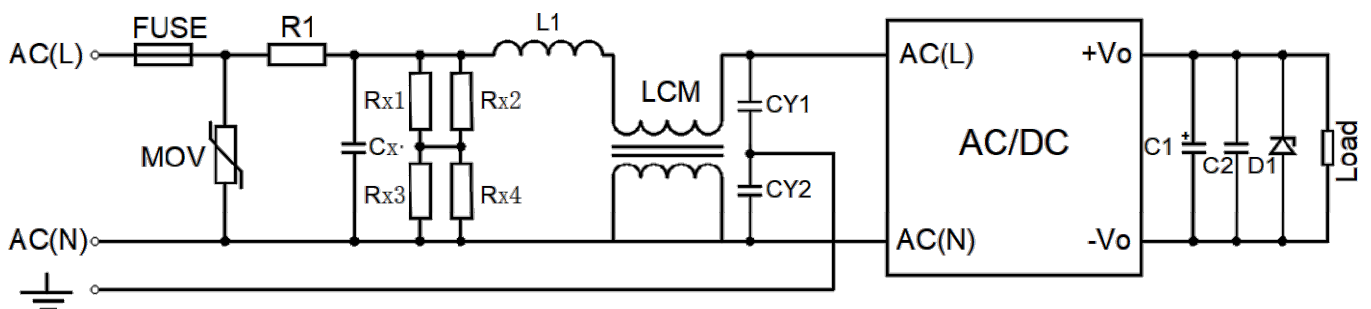

Recommended parameter values for EMC solution circuits	
Model	Recommended value
FUSE	2A/300VAC, slow-blow, required
MOV	14D561K
Cx	0.1uF/275VAC
L1	1.2mH/0.3A
CY1, CY2	1nF/400VAC
LCM	20mH Common mode Choke
Rx1,Rx2,Rx3,Rx4	2MΩ/1206

Dimensions and Recommended Layout

Dimensions

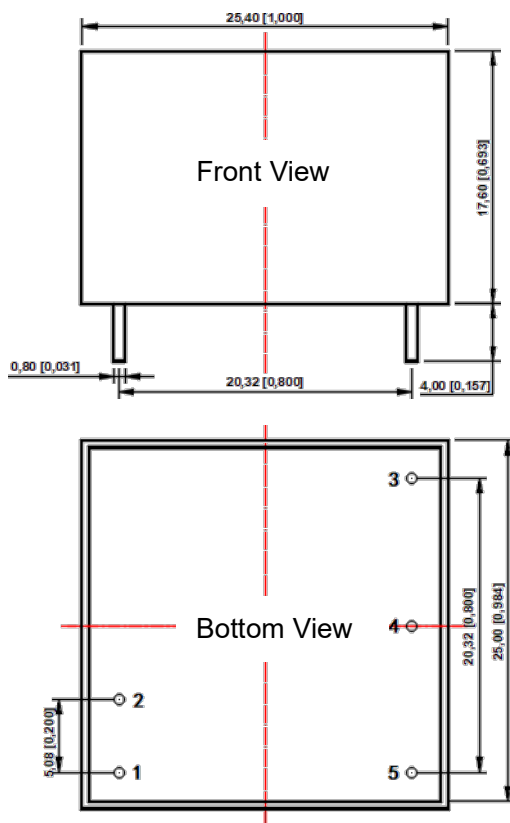

PCB Printing Layout

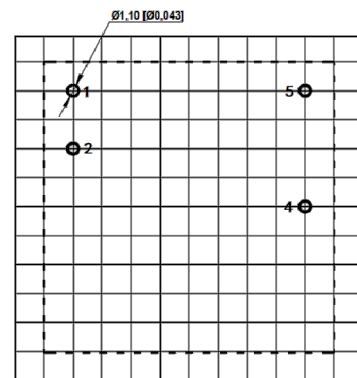

Pin Function Table

Pin	Function
1	AC(N)
2	AC(L)
3	No Pin
4	-Vo
5	+Vo

Note:

Unit: mm[inch]

Pin section tolerances: ±0.10 [±0.004]

General tolerances: ±0.50 [±0.020]

AC/DC CONVERTER——LD03-23BxxR2 Series

Note:

1. The input voltage cannot exceed the specified range value, otherwise permanent and irreparable damage may be caused ;
2. Unless otherwise specified,the parameters in this datasheet were measured at 25°C, humidity 40%~75%, input nominal voltage and output pure resistance mode under full load;
3. All index test methods are based on our company's enterprise standards.