

100W isolated DC-DC converter  
Wide input and regulated single output



## FEATURES

- Wide input voltage range: 36V-75V
- High efficiency up to 92%
- I/O isolation test voltage 1500 VDC
- Input under-voltage protection, output short circuit, over-current, over-voltage protection
- Operating ambient temperature range: -40°C to +85°C
- Industry standard package: 1/16 brick, meet DOSA standard

CE UK CA cRU US Patent Protection RoHS



EN62368-1 BS EN62368-1 UL62368

VCB48\_SBO-100W(F)R3(-N) series of isolated 100W DC-DC converter products with an wide 2:1 input voltage range. They feature efficiencies up to 92%, input to output isolation is tested with 1500VDC and the converter safety operate ambient temperature of -40°C to +85°C, input under-voltage protection, output over-voltage, over-current, short-circuit protection. They are widely used in communication field, such as switches, repeaters, intelligent communication gateways, GPS synchronous clock and 4G/5G base station etc.

## Selection Guide

| Certification | Part No. ①           | Ctrl Logic ② | Input Voltage (VDC) |        | Output        |                       | Full Load Efficiency ③ (%) Min./Typ. | Capacitive Load (uF)Max. |
|---------------|----------------------|--------------|---------------------|--------|---------------|-----------------------|--------------------------------------|--------------------------|
|               |                      |              | Nominal (Range)     | Max. ④ | Voltage (VDC) | Current(mA) Max./Min. |                                      |                          |
| EN/BS EN/UL   | VCB4805SBO-100WR3    | P            | 48<br>(36-75)       | 80     | 05            | 20000/0               | 90/92                                | 6000                     |
|               | VCB4812SBO-100WR3    |              |                     |        | 12            | 8333/0                | 90/92                                | 2000                     |
|               | VCB4828SBO-100WR3    |              |                     |        | 28            | 3571/0                | 88/90                                | 1000                     |
|               | VCB4805SBO-100WFR3   |              |                     |        | 05            | 20000/0               | 90/92                                | 6000                     |
|               | VCB4812SBO-100WFR3   |              |                     |        | 12            | 8333/0                | 90/92                                | 2000                     |
|               | VCB4828SBO-100WFR3   |              |                     |        | 28            | 3571/0                | 88/90                                | 1000                     |
|               | VCB4805SBO-100WR3-N  | N            |                     |        | 05            | 20000/0               | 90/92                                | 6000                     |
|               | VCB4812SBO-100WR3-N  |              |                     |        | 12            | 8333/0                | 90/92                                | 2000                     |
|               | VCB4828SBO-100WR3-N  |              |                     |        | 28            | 3571/0                | 88/90                                | 1000                     |
|               | VCB4805SBO-100WFR3-N |              |                     |        | 05            | 20000/0               | 90/92                                | 6000                     |
|               | VCB4812SBO-100WFR3-N |              |                     |        | 12            | 8333/0                | 90/92                                | 2000                     |
|               | VCB4828SBO-100WFR3-N |              |                     |        | 28            | 3571/0                | 88/90                                | 1000                     |

Notes:

- ① Product model suffix plus "F" for the heat sink package;
- ② "P" means positive logic, "N" means negative logic;
- ③ Exceeding the maximum input voltage may cause permanent damage;
- ④ Efficiency is measured in nominal input voltage and rated output load.

## Input Specifications

| Item                                | Operating Conditions                             | Min. | Typ.    | Max.    | Unit |
|-------------------------------------|--|------|---------|---------|------|
| Input Current (full load / no-load) | Nominal input voltage                            | --   | 2265/10 | 2368/30 | mA   |
| Reflected Ripple Current            |  | --   | 30      | --      |      |
| Surge Voltage (1sec. max.)          |  | -0.7 | --      | 80      | VDC  |
| Start-up Voltage                    |  | --   | --      | 36      |      |
| Input Under-voltage Protection      |  | 26   | 29      | --      |      |
| Start-up Time                       | Nominal input voltage & constant resistance load | --   | --      | 100     | ms   |

| Input Filter      |                       | Pi filter              |  |   |    |
|-------------------|-----------------------|------------------------|--|---|----|
| Hot Plug          |                       | Unavailable            |  |   |    |
| Ctrl <sup>①</sup> | VCB48_SBO-100W(F)R3   | Module on              | Ctrl pin open or pulled high (TTL 4.5-12VDC) |   |    |
|                   |                       | Module off             | Ctrl pin pulled low to GND (0-1.2VDC)        |   |    |
|                   |                       | Input current when off | --   | 3 | 10 |
|                   | VCB48_SBO-100W(F)R3-N | Module on              | Ctrl pin pulled low to GND (0-1.2VDC)        |   |    |
|                   |                       | Module off             | Ctrl pin open or pulled high (TTL 4.5-12VDC) |   |    |
|                   |                       | Input current when off | --   | 3 | 10 |

Note: <sup>①</sup>The Ctrl pin voltage is referenced to input GND.

## Output Specifications

| Item                         | Operating Conditions                                  | Min.                      | Typ. | Max.  | Unit  |     |
|------------------------------|---|---------------------------|------|-------|-------|-----|
| Voltage Accuracy             | 5%-100% load  | --                        | ±1   | ±3    | %Vo   |     |
| Linear Regulation            | Input voltage variation from low to high at full load | --                        | ±0.2 | ±0.5  |       |     |
| Load Regulation              | 5%-100% load  | --                        | ±0.5 | ±0.75 |       |     |
| Transient Recovery Time      | 25% load step change                                  | --                        | 200  | 500   | μs    |     |
| Transient Response Deviation | 25% load step change                                  | 5V output                 | --   | ±3    | ±8    | %Vo |
|                              |   | Others                    | --   | ±3    | ±7    |     |
| Temperature Coefficient      | Full load   | --                        | --   | ±0.03 | %/°C  |     |
| Ripple & Noise <sup>①</sup>  | 20MHz bandwidth, nominal input voltage, 5%-100% load  | --                        | 100  | 150   | mVp-p |     |
| Trim                         |   | 90                        | --   | 110   | %Vo   |     |
| Sense                        |   | --                        | --   | 105   |       |     |
| Over-voltage Protection      |   | 110                       | 125  | 160   |       |     |
| Over-current Protection      | Input voltage range                                   | 110                       | 140  | 190   | %Io   |     |
| Short-circuit Protection     |   | Continuous, self-recovery |      |       |       |     |

Note:  
<sup>①</sup>Linear Regulation at 0%-100% load is ±3% max.  
<sup>②</sup>The "Tip and barrel" method is used for ripple and noise test, please refer to *DC-DC Converter Application Notes* for specific information. Ripple & Noise at <5% load is 5%Vo max, Ripple & Noise at 28V output is 2%Vo max.

## General Specifications

| Item                             | Operating Conditions  | Min.                                  | Typ. | Max. | Unit    |
|----------------------------------|---|---------------------------------------|------|------|---------|
| Isolation Voltage                | Input-output Electric Strength Test for 1 minute with a leakage current of 1mA max. | 1500                                  | --   | --   | VDC     |
| Insulation Resistance            | Input-output resistance at 500VDC   | 1000                                  | --   | --   | MΩ      |
| Isolation Capacitance            | Input-output capacitance at 100kHz/0.1V   | --                                    | 1000 | --   | pF      |
| Operating Temperature            | See Fig1  | -40                                   | --   | +85  | °C      |
| Storage Temperature              |   | -55                                   | --   | +125 |         |
| Storage Humidity                 | Non-condensing  | 5                                     | --   | 95   | %RH     |
| Shock and Vibration Test         |   | 10-55Hz, 10G, 30Min. along X, Y and Z |      |      |         |
| Switching Frequency <sup>①</sup> | PWM mode  | --                                    | 300  | --   | kHz     |
| MTBF                             | MIL-HDBK-217F@25°C  | 500                                   | --   | --   | k hours |

Note: <sup>①</sup>Switching frequency is measured at full load. The module reduces the switching frequency for light load (below 50%) efficiency improvement.

## Mechanical Specifications

|            |                           |                          |
|------------|---------------------------|--------------------------|
| Dimensions | VCB4805/12SBO-100WR3(-N)  | 33.02 x 22.86 x 9.75 mm  |
|            | VCB4805/12SBO-100WFR3(-N) | 33.02 x 22.86 x 12.70 mm |
|            | VCB4828SBO-100WR3(-N)     | 33.02 x 22.86 x 10.05 mm |
|            | VCB4828SBO-100WFR3(-N)    | 33.02 x 22.86 x 13.00 mm |
| Weight     | VCB48_SBO-100WR3(-N)      | 14.60g (Typ.)            |
|            | VCB48_SBO-100WFR3(-N)     | 21.40g (Typ.)            |

|                |   |
|----------------|---|
| Cooling method | Natural convection or forced air convection |
|----------------|---|

### Electromagnetic Compatibility (EMC)

|           |       |   |
|-----------|-------|---|
| Emissions | CE    | CISPR32/EN55032 CLASS A (see Fig.4 for recommended circuit)/CLASS B (see Fig.5 for recommended circuit) |
|           | RE    | CISPR32/EN55032 CLASS A (see Fig.4 for recommended circuit)/CLASS B (see Fig.5 for recommended circuit) |
| Immunity  | ESD   | IEC/EN61000-4-2 Contact $\pm 6kV$ /Air $\pm 8kV$ perf. Criteria B                                       |
|           | RS    | IEC/EN61000-4-3 10V/m perf. Criteria B  |
|           | EFT   | IEC/EN61000-4-4 100kHz $\pm 2kV$ (see Fig.4 for recommended circuit) perf. Criteria B                   |
|           | Surge | IEC/EN61000-4-5 line to line $\pm 2kV$ (see Fig.4 for recommended circuit) perf. Criteria B             |
|           | CS    | IEC/EN61000-4-6 3 Vr.m.s perf. Criteria B   |

### Temperature Derating Curve

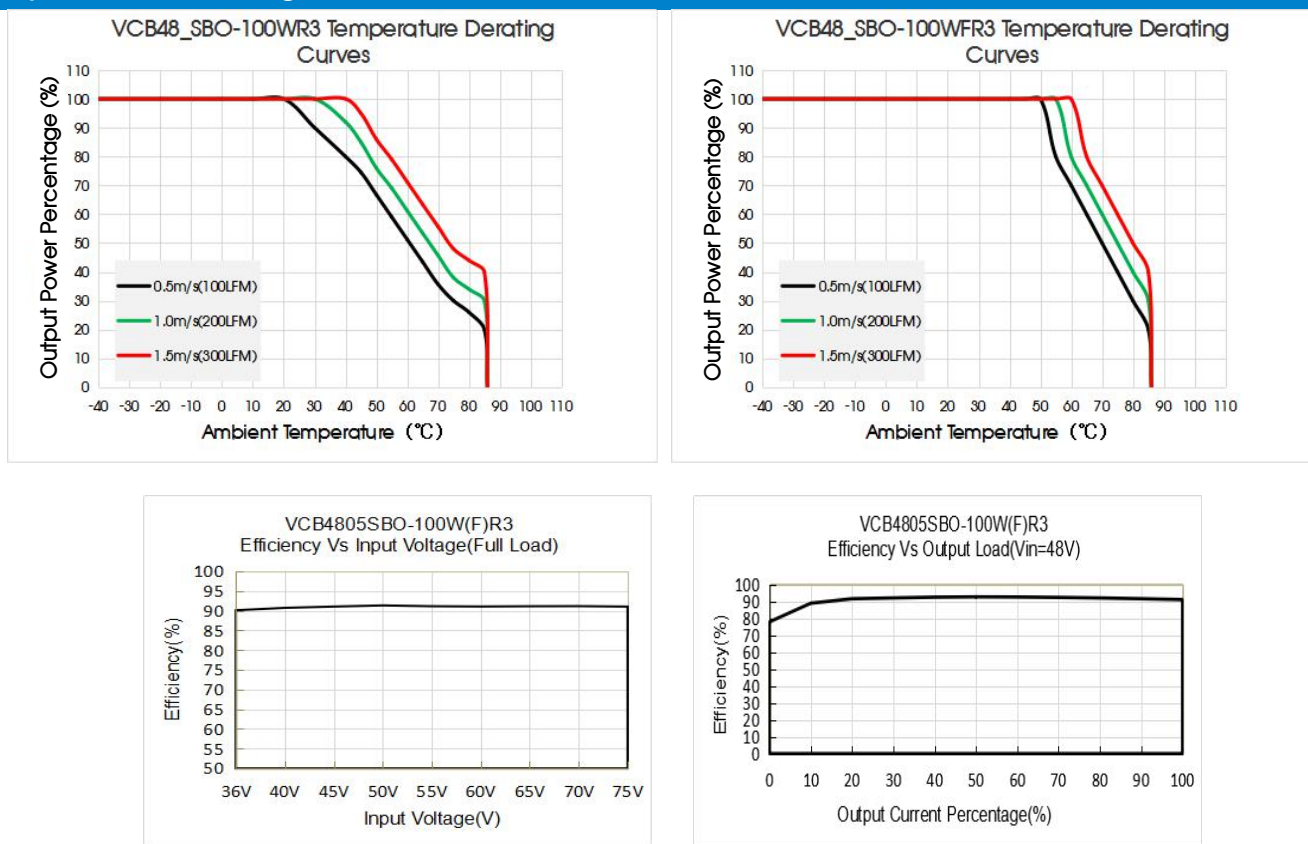
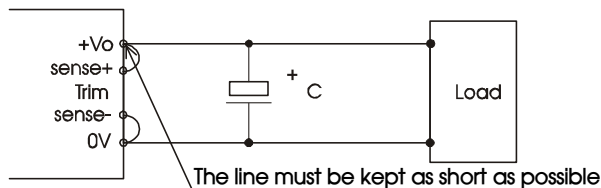

Fig.1

Note: For reference only.

### Remote Sense Application

#### 1. Remote Sense Connection if not used



Notes:

- (1) If the sense function is not used for remote regulation the user must connect the +Sense to +Vo and -Sense to 0V;
- (2) The connections between Sense lines and their respective power lines must be kept as short as possible, otherwise they may be picking up noise, interference and/or causing unstable operation of the power module.

## 2. Remote Sense Connection used for Compensation

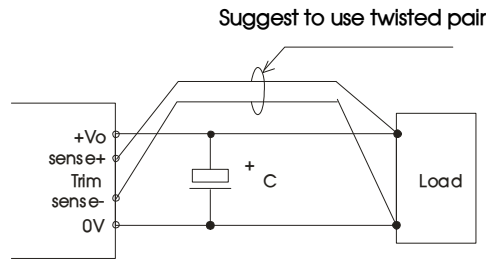

**Notes:**

- (1) Using remote sense with long wires may cause unstable output, please contact technical support if long wires must be used.
- (2) PCB-tracks or cables/wires for Remote Sense must be kept as short as possible. Twisted pair or shielded wairs are suggested for remote compensation and must be kept as short as possible.
- (3) We recommend using adequate cross section for PCB-track layout and/or cables to connect the power supply module to the load in order to keep the voltage drop below 0.3V and to make sure the power supply's output voltage remains within the specified range.
- (4) Note that large wire impedance may cause oscillation of the output voltage and/or increased ripple. Consult technical support or factory for further advice of sense operation.

## Design Reference

### 1. Ripple & Noise

All the DC-DC converters of this series are tested before delivery using the recommended circuit shown in Fig. 2.

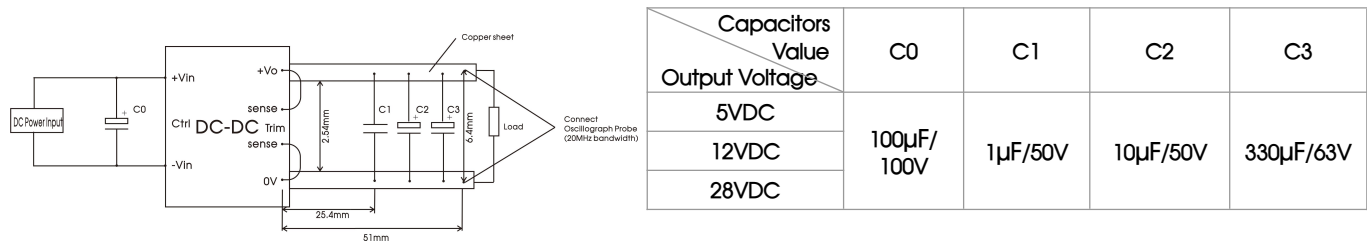

Fig. 2

### 2. Typical application

We recommended using Mornsun's EMC circuit, otherwise please ensure that at least a 100μF electrolytic capacitors is connected at the input in order to ensure adequate voltage surge suppression and protection.

Input and/or output ripple can be further reduced by appropriately increasing the input & output capacitor values Cin and Cout and/or by selecting capacitors with a low ESR (equivalent series resistance). Also make sure that the capacitance is not exceeding the specified max. capacitive load value of the product.

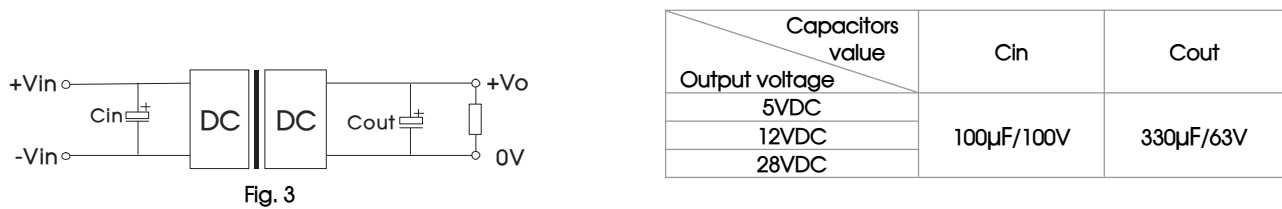
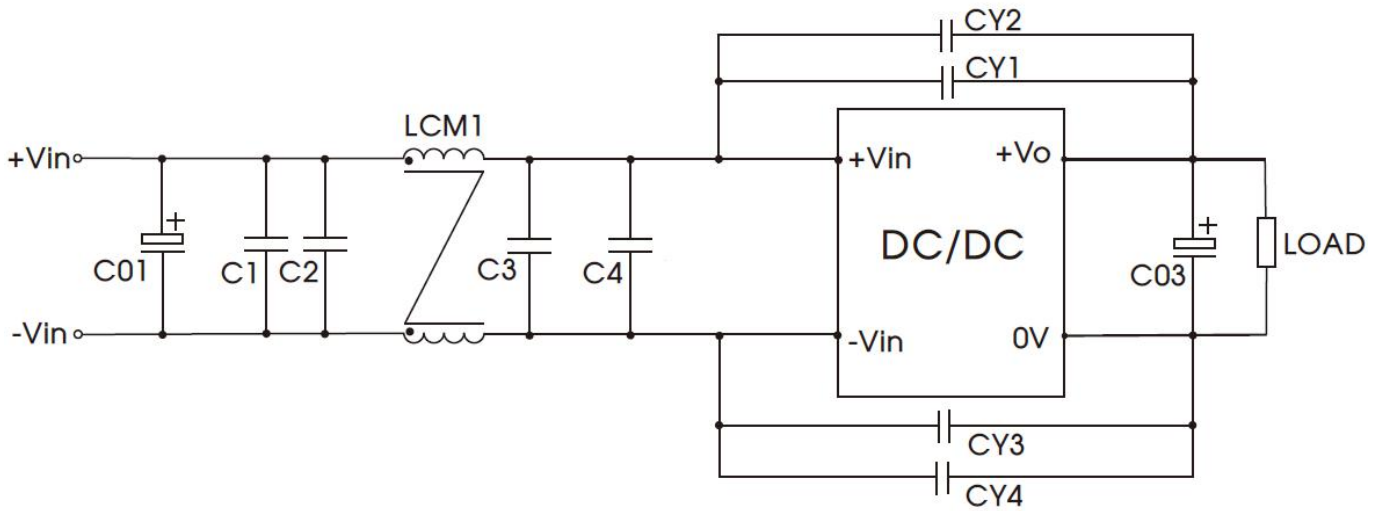

Fig. 3

3. EMC compliance recommended circuit

VCB4805/12/28SBO-100W(F)R3(-N)



|                    |  |
|--------------------|--|
| C01                | 2000uF/100V electrolytic capacitor                       |
| C03                | 330uF/100V electrolytic capacitor                        |
| C1, C2, C3, C4     | 4.7uF/100V   |
| CY1, CY2, CY3, CY4 | 222M/400V  |
| LCM1               | 2.0mH, recommended to use MORNSUN P/N:<br>FL2D-A2-202(C) |

Fig. 4

VCB4805/12SBO-100W(F)R3(-N)

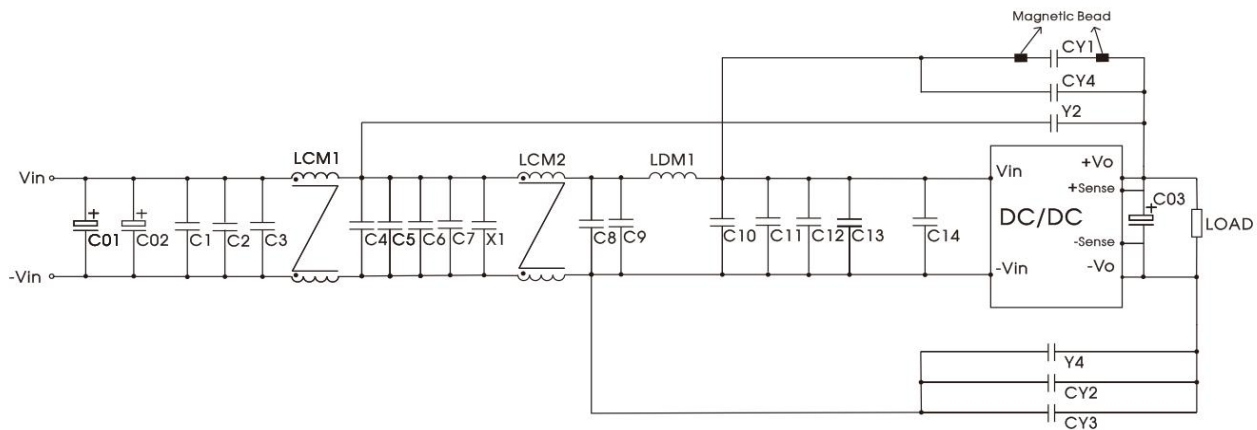

|   |   |
|---|---|
| C01, C02  | 1000µF/100V/electrolytic capacitor                    |
| C03   | 330µF/100V/electrolytic capacitor                     |
| C1, C2, C3, C4, C5, C6, C7, C8, C9, C10, C11, C12, C13, C14 | 4.7µF/100V  |
| X1  | 0.22µF/250V   |
| Y1, Y3, CY3, CY4  | 102M/400V   |
| Y2  | 332M/400V   |
| CY1, CY2  | 222M/400V   |
| LCM1  | 60µH/TL15   |
| LCM2  | 2.0µH, recommended to use MORNSUN P/N:<br>FL2D-30-222 |
| LDM1  | 12µH  |
| MB  | B40/T3.5*1.5*2.35HP (ACME)                            |



VCB4828SBO-100W(F)R3(-N)

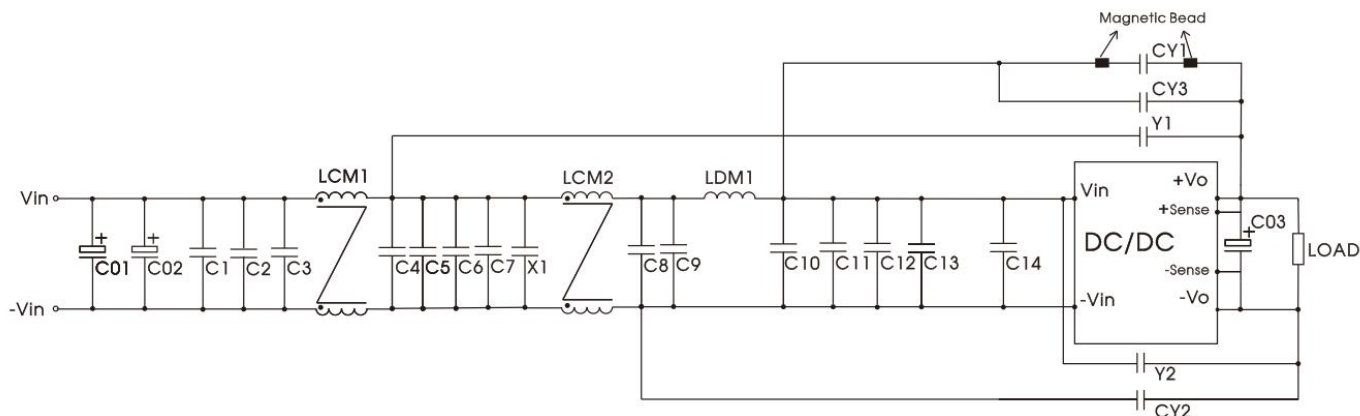

|   |  |
|---|--|
| C01, C02  | 1000µF/100V/electrolytic capacitor                 |
| C03   | 330µF/100V/electrolytic capacitor                  |
| C1, C2, C3, C4, C5, C6, C7, C8, C9, C10, C11, C12, C13, C14 | 4.7µF/100V   |
| X1  | 0.22µF/250V  |
| Y1, CY3   | 102M/400V  |
| Y2, CY2   | 332M/400V  |
| CY1   | 222M/400V  |
| LCM1  | 60µH/TL15  |
| LCM2  | 2.0µH, recommended to use MORNSUN P/N: FL2D-30-222 |
| LDM1  | 12µH   |
| MB  | B40/T3.5*1.5*2.35HP (ACME)                         |

Fig.5

4. Trim Function for Output Voltage Adjustment (open if unused)

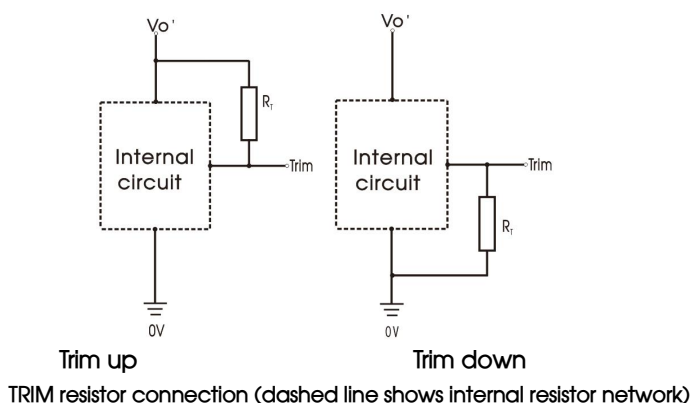

Calculating Trim resistor values:

Trim up

$$R_T = \left( \frac{5.11V_{nom}(100 + \Delta\%)}{1.225\Delta\%} - \frac{511}{\Delta\%} - 10.22 \right) (k\Omega)$$

Trim down

$$R_T = \left( \frac{511}{\Delta\%} \right) - 10.22 (k\Omega)$$

Note:

RT = Trim Resistor value

$$\Delta\% = \left| \frac{V_{nom} - V_{out}}{V_{nom}} \right| \times 100$$

$V_{nom}$  = nominal output voltage

$V_{out}$  = desired output voltage

5. Thermal test point

The thermal element is installed on the top surface of the product and dissipates heat to the surrounding environment by conduction, convection and radiation, sufficient cooling conditions shall be provided to ensure reliable operation of the product. It can be verified that cooling conditions are met by measuring the temperature of thermal test point ① in Fig.6.

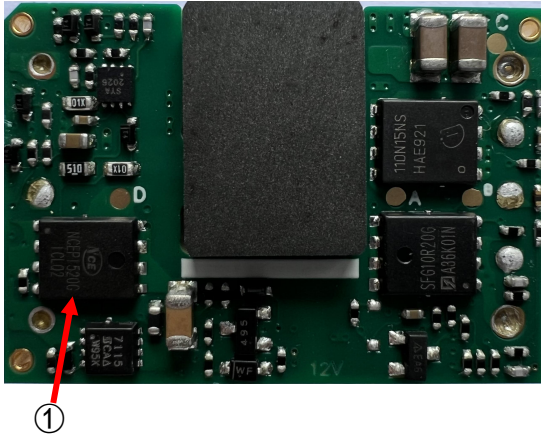

Note:

1. The temperature of the negative logic series Thermal Test Point ① cannot exceed 130°C. Otherwise, the product will trigger the protection due to excessive temperature and can not work properly.
2. Positive logic series without over-temperature protection function, the temperature of Thermal Test Point ① cannot exceed 130°C. Otherwise, the product will be damaged due to excessive temperature.

Fig. 6

6. The products do not support parallel connection of their output

7. For additional information please refer to DC-DC converter application notes on [www.mornsun-power.com](http://www.mornsun-power.com)

VCB4805(12)SBO-100WR3(-N) Dimensions and Recommended Layout

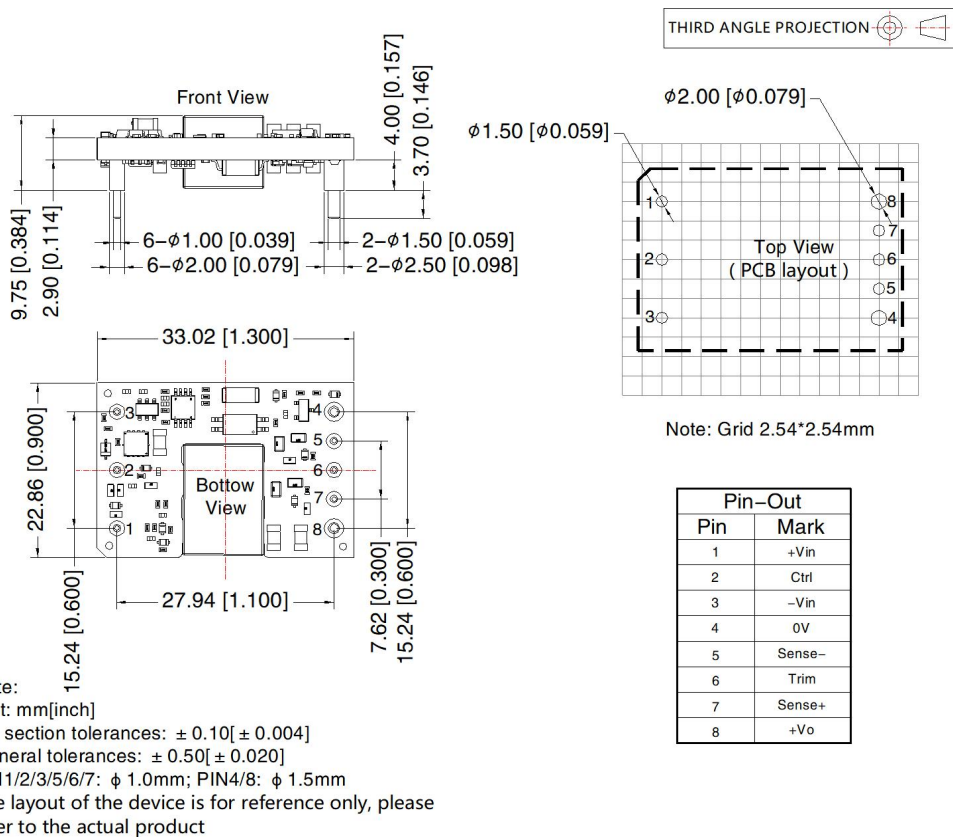

VCB4828SBO-100WR3(-N) Dimensions and Recommended Layout

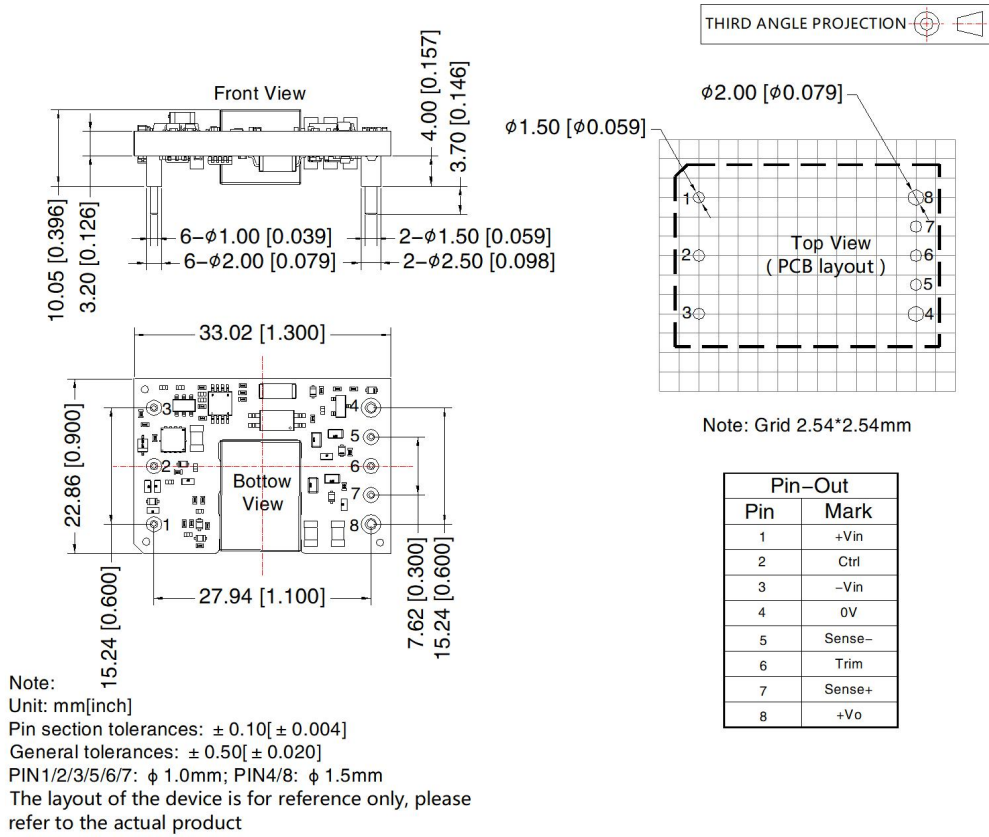

VCB4805(12)SBO-100WFR3(-N) Dimensions and Recommended Layout

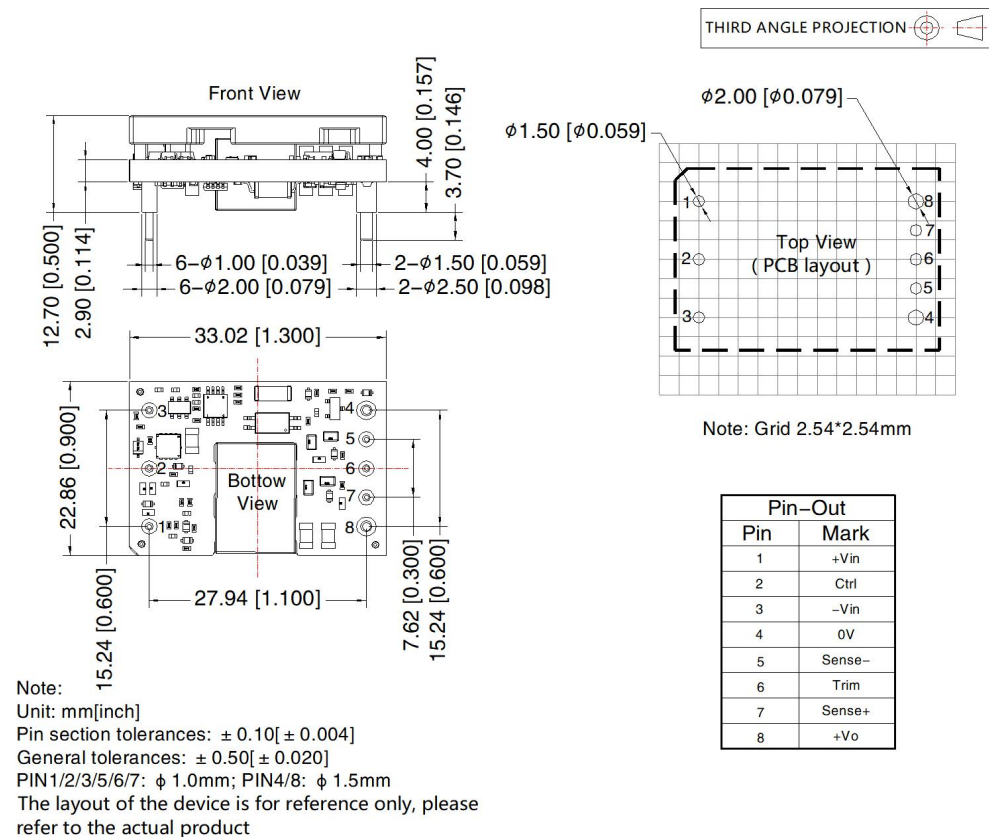



VCB4828SBO-100WFR3(-N) Dimensions and Recommended Layout

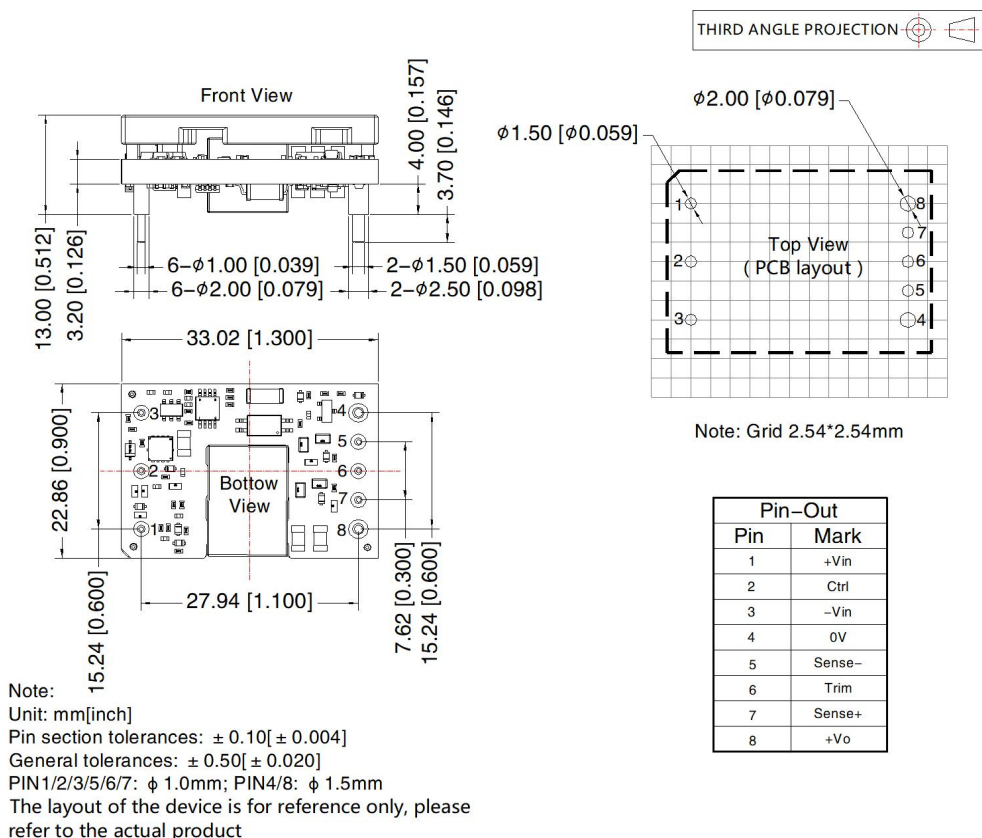

Note:

- For additional information on Product Packaging please refer to [www.mornsun-power.com](http://www.mornsun-power.com). Packaging bag number: 58200055;
- It is recommended to use at more than 10% load. If the load is lower than 10%, the ripple of the product may exceed the specifications, but the reliability of the product is not affected.
- If the product operates under the minimum required load, the product performance cannot be guaranteed to meet all performance indicators in this manual.
- The maximum capacitive load offered were tested at input voltage range and full load;
- Unless otherwise specified, parameters in this datasheet were measured under the conditions of  $T_a=25^\circ\text{C}$ , humidity<75%RH with nominal input voltage and rated output load;
- All index testing methods in this datasheet are based on company corporate standards;
- We can provide product customization service, please contact our technicians directly for specific information;
- Products are related to laws and regulations: see "Features" and "EMC";
- Our products shall be classified according to ISO14001 and related environmental laws and regulations, and shall be handled by qualified units.

Mornsun Guangzhou Science & Technology Co., Ltd.

Address: No. 5, Kehui St. 1, Kehui Development Center, Science Ave., Guangzhou Science City, Huangpu District, Guangzhou, P. R. China  
Tel: 86-20-38601850 Fax: 86-20-38601272 E-mail: [info@mornsun.cn](mailto:info@mornsun.cn) [www.mornsun-power.com](http://www.mornsun-power.com)