

Zener Voltage Regulators

500 mW SOD-123 Surface Mount

MMSZ52xxxT1G Series, SZMMSZ52xxxT1G Series

Three complete series of Zener diodes are offered in the convenient, surface mount plastic SOD-123 package. These devices provide a convenient alternative to the leadless 34-package style. Zener voltage in this series are specified with device junction in thermal equilibrium.

Features

- 500 mW Rating on FR-4 or FR-5 Board
- Wide Zener Reverse Voltage Range – 2.4 V to 110 V @ Thermal Equilibrium*
- Package Designed for Optimal Automated Board Assembly
- Small Package Size for High Density Applications
- General Purpose, Medium Current
- ESD Rating of Class 3 (> 16 kV) per Human Body Model
- SZ Prefix for Automotive and Other Applications Requiring Unique Site and Control Change Requirements; AEC-Q101 Qualified and PPAP Capable
- These are Pb-Free Devices

Mechanical Characteristics:

CASE: Void-free, transfer-molded, thermosetting plastic case

FINISH: Corrosion resistant finish, easily solderable

MAXIMUM CASE TEMPERATURE FOR SOLDERING PURPOSES:
260°C for 10 Seconds

POLARITY: Cathode indicated by polarity band

FLAMMABILITY RATING: UL 94 V-0

MAXIMUM RATINGS

Rating	Symbol	Max	Units
Total Power Dissipation on FR-5 Board, (Note 1) @ $T_L = 75^\circ\text{C}$ Deredated above 75°C	P_D	500 6.7	mW mW/°C
Thermal Resistance, Junction-to-Ambient (Note 2)	$R_{\theta JA}$	340	°C/W
Thermal Resistance, Junction-to-Lead (Note 2)	$R_{\theta JL}$	150	°C/W
Junction and Storage Temperature Range	T_J, T_{stg}	-55 to +150	°C

Stresses exceeding those listed in the Maximum Ratings table may damage the device. If any of these limits are exceeded, device functionality should not be assumed, damage may occur and reliability may be affected.

1. FR-5 = 3.5 X 1.5 inches, using the minimum recommended footprint.
2. Thermal Resistance measurement obtained via infrared Scan Method.

*For additional info on thermal equilibrium, please download, **onsemi** TVS/Zener Theory and Design Considerations Handbook, HBD854/D.



SOD-123
CASE 425
STYLE 1

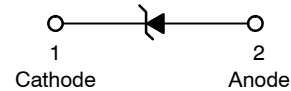

MARKING DIAGRAM



xx = Device Code (Refer to page 3)

M = Date Code

▪ = Pb-Free Package

(Note: Microdot may be in either location)

ORDERING INFORMATION

Device	Package	Shipping†
MMSZ52xxBT1G, SZMMSZ52xxBT1G	SOD-123 (Pb-Free)	3,000 / Tape & Reel
MMSZ52xxCT1G, SZMMSZ52xxCT1G	SOD-123 (Pb-Free)	3,000 / Tape & Reel
MMSZ52xxBT3G, SZMMSZ52xxBT3G	SOD-123 (Pb-Free)	10,000 / Tape & Reel
MMSZ52xxCT3G, SZMMSZ52xxCT3G	SOD-123 (Pb-Free)	10,000 / Tape & Reel

†For information on tape and reel specifications, including part orientation and tape sizes, please refer to our Tape and Reel Packaging Specifications Brochure, BRD8011/D.

DEVICE MARKING INFORMATION

See specific marking information in the device marking column of the Electrical Characteristics table on page 3 of this data sheet.

MMSZ52xxxT1G Series, SZMMSZ52xxxT1G Series

ELECTRICAL CHARACTERISTICS ($T_A = 25^\circ\text{C}$ unless otherwise noted, $V_F = 0.95\text{ V Max. @ } I_F = 10\text{ mA}$)

Symbol	Parameter
V_Z	Reverse Zener Voltage @ I_{ZT}
I_{ZT}	Reverse Current
Z_{ZT}	Maximum Zener Impedance @ I_{ZT}
I_{ZK}	Reverse Current
Z_{ZK}	Maximum Zener Impedance @ I_{ZK}
I_R	Reverse Leakage Current @ V_R
V_R	Reverse Voltage
I_F	Forward Current
V_F	Forward Voltage @ I_F

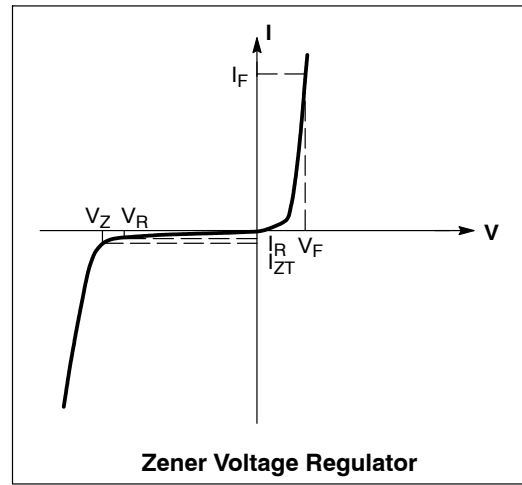

MMSZ52xxxT1G Series, SZMMSZ52xxxT1G Series

5% TOLERANCE FG ELECTRICAL CHARACTERISTICS ($T_A = 25^\circ\text{C}$ unless otherwise noted, $V_F = 0.9\text{ V Max.}$ @ $I_F = 10\text{ mA}$)

Device*	Device Marking	Zener Voltage (Notes 3 and 4)			Zener Impedance (Note 5)			Leakage Current		
		V_Z (Volts)			@ I_{ZT}	Z_{ZT} @ I_{ZT}	Z_{ZK} @ I_{ZK}		I_R @ V_R	
		Min	Nom	Max	mA	Ω	Ω	mA	μA	Volts
MMSZ5221BT1G	C1	2.28	2.4	2.52	20	30	1200	0.25	100	1
MMSZ5222BT1G	C2	2.38	2.5	2.63	20	30	1250	0.25	100	1
MMSZ5223BT1G	C3	2.57	2.7	2.84	20	30	1300	0.25	75	1
MMSZ5224BT1G	C4	2.66	2.8	2.94	20	30	1400	0.25	75	1
MMSZ5225BT1G	C5	2.85	3.0	3.15	20	29	1600	0.25	50	1
MMSZ5226BT1G	D1	3.14	3.3	3.47	20	28	1600	0.25	25	1
MMSZ5227BT1G	D2	3.42	3.6	3.78	20	24	1700	0.25	15	1
MMSZ5228BT1G	D3	3.71	3.9	4.10	20	23	1900	0.25	10	1
MMSZ5229BT1G	D4	4.09	4.3	4.52	20	22	2000	0.25	5	1
MMSZ5230BT1G	D5	4.47	4.7	4.94	20	19	1900	0.25	5	2
MMSZ5231BT1G	E1	4.85	5.1	5.36	20	17	1600	0.25	5	2
MMSZ5232BT1G	E2	5.32	5.6	5.88	20	11	1600	0.25	5	3
MMSZ5233BT1G	E3	5.70	6.0	6.30	20	7	1600	0.25	5	3.5
MMSZ5234BT1G	E4	5.89	6.2	6.51	20	7	1000	0.25	5	4
MMSZ5235BT1G	E5	6.46	6.8	7.14	20	5	750	0.25	3	5
MMSZ5236BT1G	F1	7.13	7.5	7.88	20	6	500	0.25	3	6
MMSZ5237BT1G	F2	7.79	8.2	8.61	20	8	500	0.25	3	6.5
MMSZ5238BT1G	F3	8.27	8.7	9.14	20	8	600	0.25	3	6.5
MMSZ5239BT1G	F4	8.65	9.1	9.56	20	10	600	0.25	3	7
MMSZ5240BT1G	F5	9.50	10	10.50	20	17	600	0.25	3	8
MMSZ5241BT1G	H1	10.45	11	11.55	20	22	600	0.25	2	8.4
MMSZ5242BT1G/T3G	H2	11.40	12	12.60	20	30	600	0.25	1	9.1
MMSZ5243BT1G	H3	12.35	13	13.65	9.5	13	600	0.25	0.5	9.9
MMSZ5244BT1G	H4	13.30	14	14.70	9.0	15	600	0.25	0.1	10
MMSZ5245BT1G	H5	14.25	15	15.75	8.5	16	600	0.25	0.1	11
MMSZ5246BT1G	J1	15.20	16	16.80	7.8	17	600	0.25	0.1	12
MMSZ5247BT1G	J2	16.15	17	17.85	7.4	19	600	0.25	0.1	13
MMSZ5248BT1G	J3	17.10	18	18.90	7.0	21	600	0.25	0.1	14
MMSZ5249BT1G	J4	18.05	19	19.95	6.6	23	600	0.25	0.1	14
MMSZ5250BT1G	J5	19.00	20	21.00	6.2	25	600	0.25	0.1	15
MMSZ5251BT1G	K1	20.90	22	23.10	5.6	29	600	0.25	0.1	17
MMSZ5252BT1G	K2	22.80	24	25.20	5.2	33	600	0.25	0.1	18
MMSZ5253BT1G	K3	23.75	25	26.25	5.0	35	600	0.25	0.1	19
MMSZ5254BT1G/T3G	K4	25.65	27	28.35	4.6	41	600	0.25	0.1	21
MMSZ5255BT1G	K5	26.60	28	29.40	4.5	44	600	0.25	0.1	21
MMSZ5256BT1G	M1	28.50	30	31.50	4.2	49	600	0.25	0.1	23
MMSZ5257BT1G	M2	31.35	33	34.65	3.8	58	700	0.25	0.1	25
MMSZ5258BT1G/T3G	M3	34.20	36	37.80	3.4	70	700	0.25	0.1	27
MMSZ5259BT1G	M4	37.05	39	40.95	3.2	80	800	0.25	0.1	30
MMSZ5260BT1G	M5	40.85	43	45.15	3.0	93	900	0.25	0.1	33
MMSZ5261BT1G	N1	44.65	47	49.35	2.7	105	1000	0.25	0.1	36
MMSZ5262BT1G	N2	48.45	51	53.55	2.5	125	1100	0.25	0.1	39
MMSZ5263BT1G	N3	53.20	56	58.80	2.2	150	1300	0.25	0.1	43
MMSZ5264BT1G	N4	57.00	60	63.00	2.1	170	1400	0.25	0.1	46
MMSZ5265BT1G	N5	58.90	62	65.10	2.0	185	1400	0.25	0.1	47
MMSZ5266BT1G	P1	64.60	68	71.40	1.8	230	1600	0.25	0.1	52
MMSZ5267BT1G	P2	71.25	75	78.75	1.7	270	1700	0.25	0.1	56
MMSZ5268BT1G	P3	77.90	82	86.10	1.5	330	2000	0.25	0.1	62
MMSZ5269BT1G	P4	82.65	87	91.35	1.4	370	2200	0.25	0.1	68
MMSZ5270BT1G	P5	86.45	91	95.55	1.4	400	2300	0.25	0.1	69
MMSZ5272BT1G/T3G	R2	104.5	110	115.5	1.1	750	3000	0.25	0.1	84

*Includes SZ-prefix devices where applicable.

3. "B" Suffix Type numbers shown have a standard tolerance of $\pm 5\%$ on the nominal Zener voltages.

4. Nominal Zener voltage is measured with the device junction in thermal equilibrium at $T_L = 30^\circ\text{C} \pm 1^\circ\text{C}$.

5. Z_{ZT} and Z_{ZK} are measured by dividing the AC voltage drop across the device by the ac current applied.

The specified limits are for $I_{Z(AC)} = 0.1 I_{Z(dc)}$ with the AC frequency = 1 kHz.

MMSZ52xxxT1G Series, SZMMSZ52xxxT1G Series

2% TOLERANCE FG ELECTRICAL CHARACTERISTICS ($T_A = 25^\circ\text{C}$ unless otherwise noted, $V_F = 0.9\text{ V Max.}$ @ $I_F = 10\text{ mA}$)

Device*	Device Marking	Zener Voltage (Notes 6 and 7)			Zener Impedance (Note 8)			Leakage Current		
		V_Z (Volts)			@ I_{ZT}	Z_{ZT} @ I_{ZT}	Z_{ZK} @ I_{ZK}		I_R @ V_R	
		Min	Nom	Max	mA	Ω	Ω	mA	μA	Volts
MMSZ5226CT1G	TD	3.234	3.3	3.366	20	28	1600	0.25	25	1
MMSZ5231CT1G	TG	4.998	5.1	5.202	20	17	1600	0.25	5	2
MMSZ5232CT1G	TH	5.488	5.6	5.712	20	11	1600	0.25	5	3
MMSZ5245CT1G	TK	14.70	15	15.30	8.5	16	600	0.25	0.1	11
MMSZ5248CT1G	TL	17.64	18	18.36	7.0	21	600	0.25	0.1	14
MMSZ5250CT1G	TN	19.60	20	20.40	6.2	25	600	0.25	0.1	15
MMSZ5252CT1G	TQ	23.52	24	24.48	5.2	33	600	0.25	0.1	18
MMSZ5256CT1G	TW	29.40	30	30.60	4.2	49	600	0.25	0.1	23
MMSZ5258CT1G	TX	35.28	36	36.72	3.4	70	700	0.25	0.1	27

6. "C" Suffix Type numbers shown have a standard tolerance of $\pm 2\%$ on the nominal Zener voltages.

7. Nominal Zener voltage is measured with the device junction in thermal equilibrium at $T_L = 30^\circ\text{C} \pm 1^\circ\text{C}$.

8. Z_{ZT} and Z_{ZK} are measured by dividing the AC voltage drop across the device by the ac current applied.

The specified limits are for $I_{Z(AC)} = 0.1 I_{Z(dc)}$ with the AC frequency = 1 kHz.

*Includes SZ-prefix devices where applicable.

MMSZ52xxxT1G Series, SZMMSZ52xxxT1G Series

TYPICAL CHARACTERISTICS

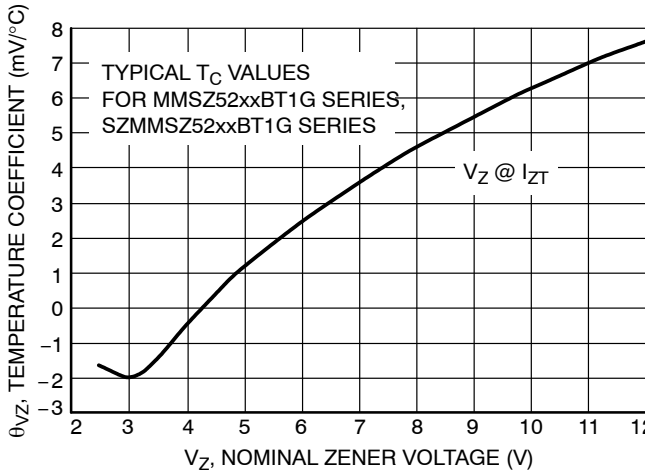

Figure 1. Temperature Coefficients (Temperature Range -55°C to +150°C)

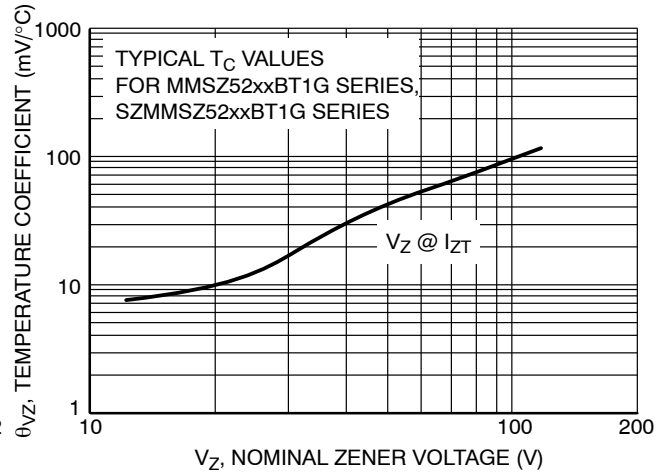

Figure 2. Temperature Coefficients (Temperature Range -55°C to +150°C)

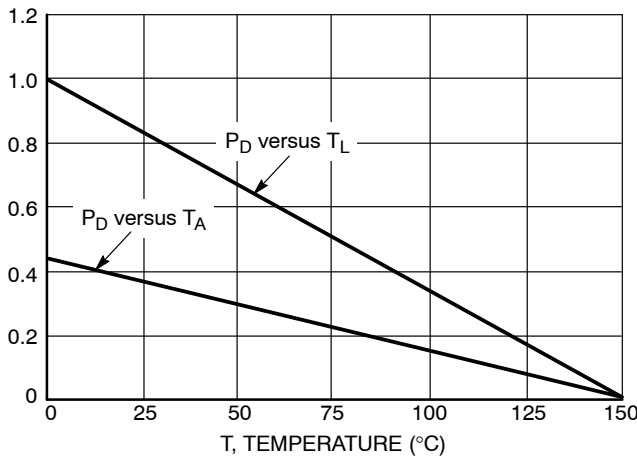

Figure 3. Steady State Power Derating

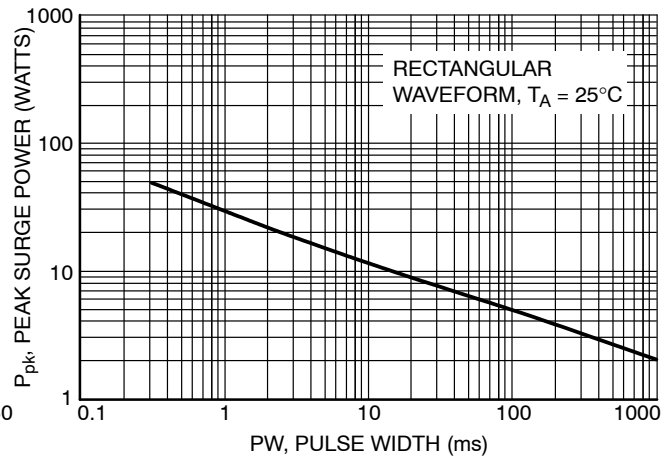

Figure 4. Maximum Nonrepetitive Surge Power

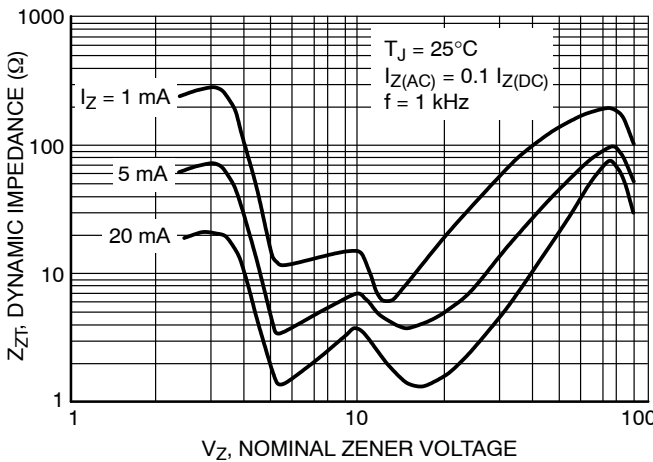

Figure 5. Effect of Zener Voltage on Zener Impedance

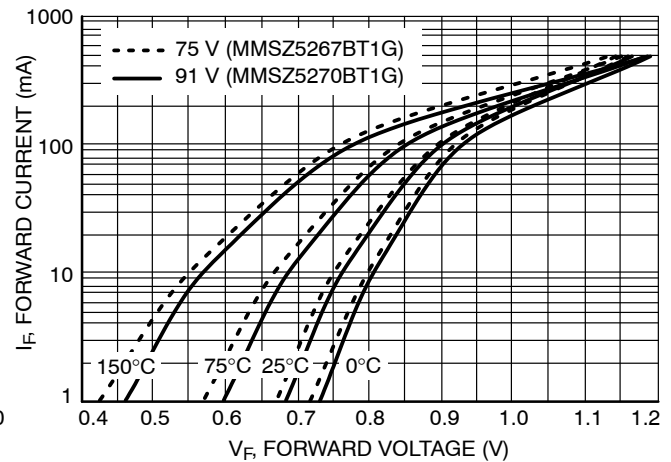

Figure 6. Typical Forward Voltage

MMSZ52xxxT1G Series, SZMMSZ52xxxT1G Series

TYPICAL CHARACTERISTICS

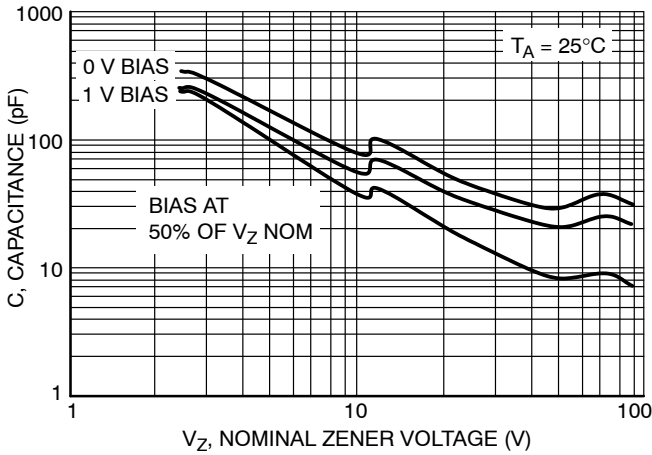

Figure 7. Typical Capacitance

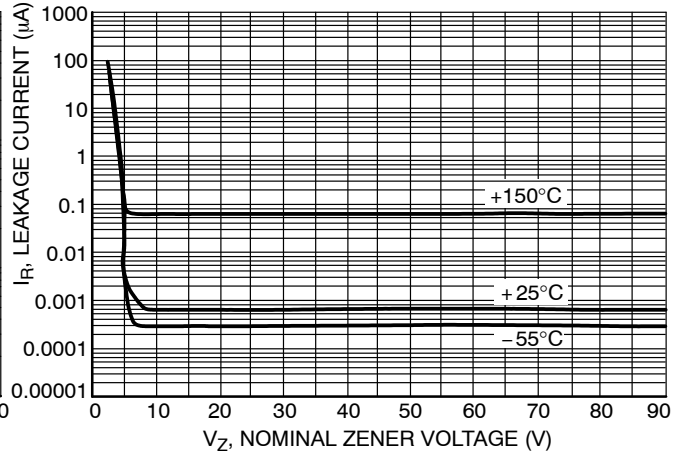

Figure 8. Typical Leakage Current

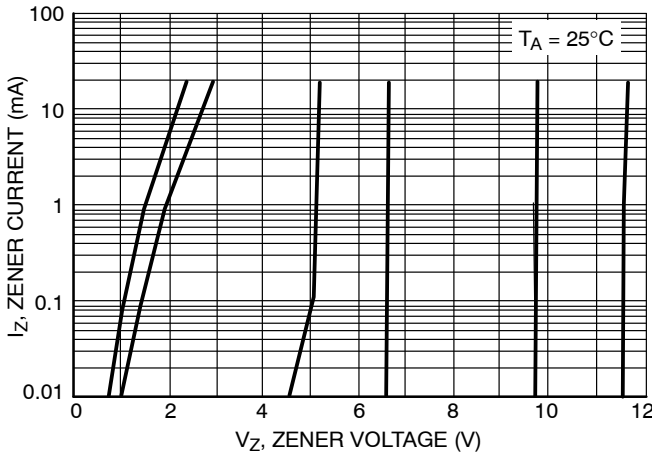

Figure 9. Zener Voltage versus Zener Current (V_Z Up to 12 V)

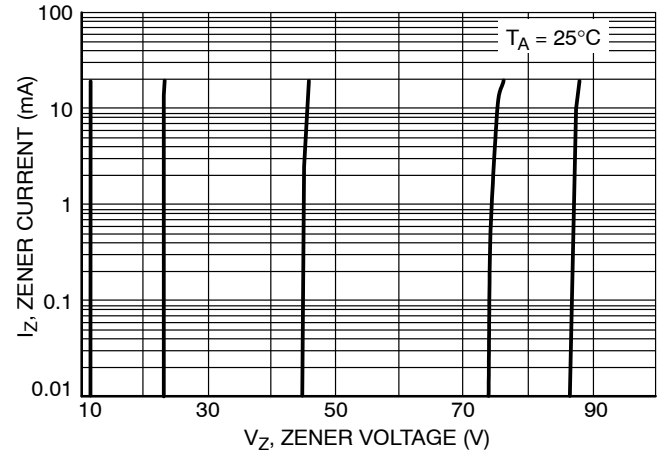

Figure 10. Zener Voltage versus Zener Current (12 V to 91 V)

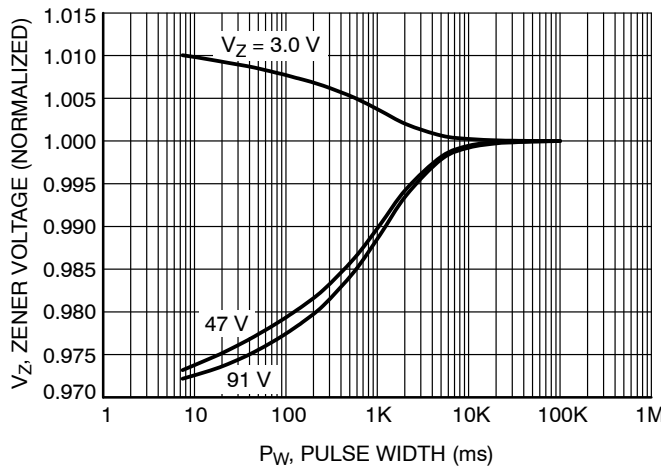

Figure 11. SOD-123 (plastic) 500 Watt Device

MECHANICAL CASE OUTLINE

PACKAGE DIMENSIONS



SOD-123
CASE 425-04
ISSUE G

DATE 07 OCT 2009

SCALE 5:1

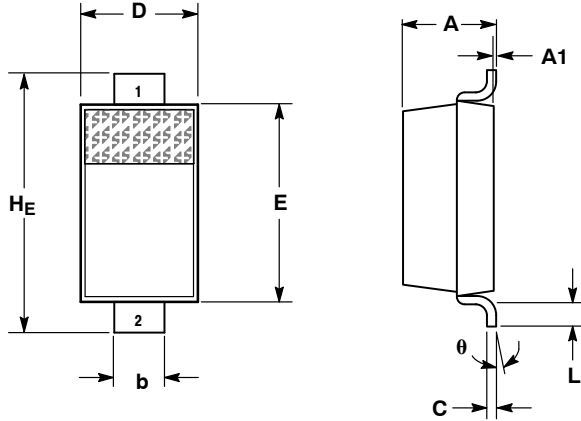

- NOTES:
1. DIMENSIONING AND TOLERANCING PER ANSI Y14.5M, 1982.
2. CONTROLLING DIMENSION: INCH.

DIM	MILLIMETERS			INCHES		
	MIN	NOM	MAX	MIN	NOM	MAX
A	0.94	1.17	1.35	0.037	0.046	0.053
A1	0.00	0.05	0.10	0.000	0.002	0.004
b	0.51	0.61	0.71	0.020	0.024	0.028
c	---	---	0.15	---	---	0.006
D	1.40	1.60	1.80	0.055	0.063	0.071
E	2.54	2.69	2.84	0.100	0.106	0.112
HE	3.56	3.68	3.86	0.140	0.145	0.152
L	0.25	---	---	0.010	---	---
θ	0°	---	10°	0°	---	10°

RECOMMENDED SOLDERING FOOTPRINT*

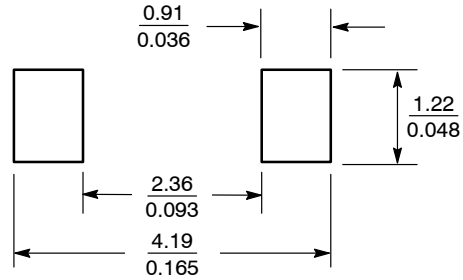

SCALE 10:1 (mm/inches)

GENERIC MARKING DIAGRAM*



- XXX = Specific Device Code
- M = Date Code
- = Pb-Free Package

(Note: Microdot may be in either location)

*This information is generic. Please refer to device data sheet for actual part marking. Pb-Free indicator, "G" or microdot "▪", may or may not be present. Some products may not follow the Generic Marking.

*For additional information on our Pb-Free strategy and soldering details, please download the **onsemi** Soldering and Mounting Techniques Reference Manual, SOLDERRM/D.

STYLE 1:
PIN 1. CATHODE
2. ANODE

DOCUMENT NUMBER:	98ASB42927B	Electronic versions are uncontrolled except when accessed directly from the Document Repository. Printed versions are uncontrolled except when stamped "CONTROLLED COPY" in red.
DESCRIPTION:	SOD-123	PAGE 1 OF 1

onsemi and **ONSEMI** are trademarks of Semiconductor Components Industries, LLC dba **onsemi** or its subsidiaries in the United States and/or other countries. **onsemi** reserves the right to make changes without further notice to any products herein. **onsemi** makes no warranty, representation or guarantee regarding the suitability of its products for any particular purpose, nor does **onsemi** assume any liability arising out of the application or use of any product or circuit, and specifically disclaims any and all liability, including without limitation special, consequential or incidental damages. **onsemi** does not convey any license under its patent rights nor the rights of others.

onsemi, **Onsemi**, and other names, marks, and brands are registered and/or common law trademarks of Semiconductor Components Industries, LLC dba "**onsemi**" or its affiliates and/or subsidiaries in the United States and/or other countries. **onsemi** owns the rights to a number of patents, trademarks, copyrights, trade secrets, and other intellectual property. A listing of **onsemi**'s product/patent coverage may be accessed at www.onsemi.com/site/pdf/Patent-Marking.pdf. **onsemi** reserves the right to make changes at any time to any products or information herein, without notice. The information herein is provided "as-is" and **onsemi** makes no warranty, representation or guarantee regarding the accuracy of the information, product features, availability, functionality, or suitability of its products for any particular purpose, nor does **onsemi** assume any liability arising out of the application or use of any product or circuit, and specifically disclaims any and all liability, including without limitation special, consequential or incidental damages. Buyer is responsible for its products and applications using **onsemi** products, including compliance with all laws, regulations and safety requirements or standards, regardless of any support or applications information provided by **onsemi**. "Typical" parameters which may be provided in **onsemi** data sheets and/or specifications can and do vary in different applications and actual performance may vary over time. All operating parameters, including "Typicals" must be validated for each customer application by customer's technical experts. **onsemi** does not convey any license under any of its intellectual property rights nor the rights of others. **onsemi** products are not designed, intended, or authorized for use as a critical component in life support systems or any FDA Class 3 medical devices or medical devices with a same or similar classification in a foreign jurisdiction or any devices intended for implantation in the human body. Should Buyer purchase or use **onsemi** products for any such unintended or unauthorized application, Buyer shall indemnify and hold **onsemi** and its officers, employees, subsidiaries, affiliates, and distributors harmless against all claims, costs, damages, and expenses, and reasonable attorney fees arising out of, directly or indirectly, any claim of personal injury or death associated with such unintended or unauthorized use, even if such claim alleges that **onsemi** was negligent regarding the design or manufacture of the part. **onsemi** is an Equal Opportunity/Affirmative Action Employer. This literature is subject to all applicable copyright laws and is not for resale in any manner.

ADDITIONAL INFORMATION

TECHNICAL PUBLICATIONS:

Technical Library: www.onsemi.com/design/resources/technical-documentation
onsemi Website: www.onsemi.com

ONLINE SUPPORT: www.onsemi.com/support

For additional information, please contact your local Sales Representative at www.onsemi.com/support/sales