

MATELIGHT

MATELIGHT DCC

RELEASE

产品规格书

Product specification



高速光耦

OPTOCOUPLER

MTH11LX

HIGH SPEED OPTOCOUPLER

晶体管光耦

可控硅光耦

达林顿光耦

高速光耦

施密特触发器

IPM驱动光耦

固态继电器

IGBT驱动光耦

深圳市美特光电子有限公司

SHENZHEN MATELIGHT ELECTRONICS CO.,LTD

www.matelight.cn 🔍

概述 Description

MTH11LX系列器件具备 GaAs 红外发射二极管，该二极管光学耦合到高速集成电路探测器。输出探测器包含施密特触发器，为噪声免疫和脉冲整形提供了滞后效应。

The MTH11LX series of devices each consist of a GaAs infrared emitting diode optically coupled a high speed integrated circuit detector. The output detector incorporates a Schmitt trigger, which provides hysteresis for noise immunity and pulse shaping.

特性 Features

- 高数据速率，典型频率为 2MHz(NRZ)
High data rate, 2MHz typical (NRZ)
- 在整个电压和温度范围内无门锁和振荡
Free from latch up and oscillation throughout voltage and temperature ranges
- 兼容微处理器的驱动器
Microprocessor compatible drive
- 输出在 0.4V 条件下的最大灌电流为：16mA
Logic compatible output sinks 16mA at 0.4V maximum
- 保证导通/关断阈值滞后
Guaranteed on/off threshold hysteresis
- 宽电源电压能力，兼容常见的逻辑电平
Wide supply voltage capability, compatible with all popular logic systems
- 温度范围：-55°C ~ 100°C
-55°C to 100°C temperature range
- 紧凑型双列直插式封装
Compact dual-in-line package
- 符合安规标准：UL 1577, VDE DIN EN60747-5-5 (VDE 0884-5), CQC11-471543-2022
Safety standards approval: UL 1577, VDE DIN EN60747-5-5 (VDE 0884-5), CQC11-471543-2022

应用 Applications

- 逻辑到逻辑隔离器
Logic to logic isolator
- 可编程电流电平传感器
Programmable current level sensor
- 线路接收机-消除噪声和瞬态问题
Line receiver - eliminate noise and transient problems
- AC 到 TTL 的转换-方波整形
AC to TTL conversion - square wave shaping
- 电源数字化编程
Digital programming of power supplies

真值表 Truth table

LED	VO
H	L
L	H

封装和原理图 Package and Schematic Diagram



DIP6

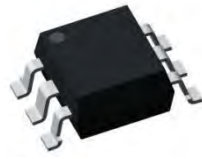

SMD6

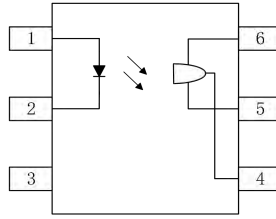

Pin Configuration

1. Anode
2. Cathode
3. NC
4. VO
5. GND
6. VCC

产品型号命名规则 Order Code

MTH11LX- UN Y - W (V) (ZZ)

① ② ③ ④ ⑤ ⑥ ⑦

① 公司代码 Company Code (MT: 美特光MT)

② 产品系列 Product Series (X: 1、2、3)

③ 内部补充代码 Internal Supplementary Code (数字或者空白 Number or None)

印字信息 Marking Information

- “MT” :代表美特光品牌简称
- “H11LX” :代表产品系列
- “Y” :代表年份/生产批次：以数字代表年份如1代表2021年，以此类推
- “WW” :代表生产周期

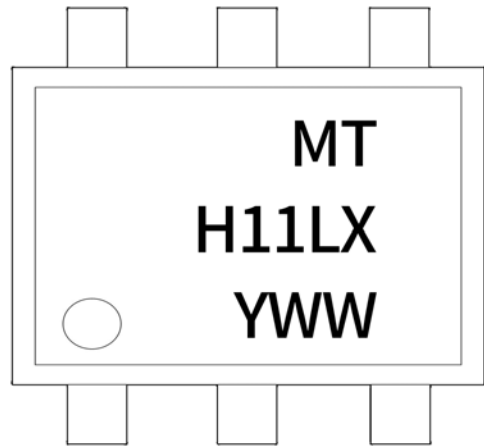

绝缘和安规信息 Insulation and Safety related specifications

项目 Item	符号 Symbol	数值 Value	单位 Unit	备注 Remark
爬电距离 Creepage Distance	L	≥ 7.6	mm	从输入端到输出端，沿本体最短距离路径 Measured from input terminals to output terminals, shortest distance path along body
电气间隙 Clearance Distance	L	≥ 7.6	mm	从输入端到输出端，通过空气的最短距离 Measured from input terminals to output terminals, shortest distance through air
绝缘距离 Insulation Thickness	DTI	≥ 0.4	mm	发射器和探测器之间的绝缘厚度 Insulation thickness between emitter and detector
峰值隔离电压 Peak Isolation Voltage	V_{IORM}	1500	V_{peak}	DIN/EN/IEC EN60747-5-5
瞬态隔离电压 Transient isolation voltage	V_{IOTM}	7000	V_{peak}	DIN/EN/IEC EN60747-5-5
隔离电压 Isolation Voltage	V_{iso}	> 5000	V_{rms}	For 1 min

极限参数 Absolute Maximum Ratings ($T_a=25^{\circ}\text{C}$)

参数 Parameter	符号 Symbol	额定值 Rating	单位 Unit
输入 Input	正向电流 Forward Current	I_F	60 mA
	反向电压 Reverse Voltage	V_R	6 V
	功耗 Power Dissipation	P_D	120 mW
输出 Output	V45 允许范围 V45 Allowed Range	V_O	0-16 V
	V65 允许范围 V65 Allowed Range	V_{CC}	3-16 V
	输出电流 Output Current	I_O	50 mA
	功耗 power dissipation	P_D	150 mW
总功耗 Total Power Dissipation	P_{tot}	250	mW
隔离电压 Isolation Voltage	V_{iso}	5000	V_{rms}
工作温度 Operating Temperature	T_{opr}	-55~+100	$^{\circ}\text{C}$
储存温度 Storage Temperature	T_{stg}	-55~+125	$^{\circ}\text{C}$
焊接温度 (10s) Soldering Temperature (10s)	T_{sol}	260	$^{\circ}\text{C}$

产品特性参数 Electro-optical Characteristics (Ta=25°C)

参数 Parameter		符号 Symbol	条件 Condition	最小 Min.	典型 Typ.	最大 Max.	单位 Unit	
输入 Input	正向电压 Forward Voltage	V_F	$I_F=10mA$	-	1.24	1.5	V	
	反向电流 Reverse Current	I_R	$V_R=5V$	-	-	10	μA	
	输入电容 Input capacitance	C_J	$V=0, f=1MHz$	-	-	100	pF	
输出 Output	电压运行范围 Operation Voltage Range	V_{CC}		3	-	15	V	
	电源电流 Supply Current	$I_{CC(off)}$	$I_F=0mA, V_{CC}=5V$		0.62	1.5	mA	
	高输出电流 Output Current, High	I_{OH}	$I_F=0mA, V_{CC}=V_O=15V$	-	-	100	μA	
	隔离电阻 Isolation Resistance	R_{ISO}	$V_{I-O}=500VDC$	10^{11}	-	-	Ω	
传输特性 Transfer Characteristics	电源电流 Supply Current	$I_{CC(on)}$	$I_F=10mA, V_{CC}=5V$	-	0.67	1.5	mA	
	低输出电压 Output Voltage .low	V_{OL}	$V_{CC}=5V, I_F=I_{Fon(max)}, R_L=270\Omega$	-	-	0.4	V	
	开启阈值电流 Turn onThreshold Current	MTH11L1	I_{Fon}	$V_{CC}=5V, R_L=270\Omega$	-	-	1.6	mA
		MTH11L2			-	-	10	
		MTH11L3			-	-	5	
	滞后比 Hysteresis Ratio	I_{Foff}/I_{Fon}	$V_{CC}=5V, R_L=270\Omega$	0.5	-	0.9		
	开启时间 Turn on Time	t_{on}	$V_{CC}=5V, I_F=I_{Fon}, R_L=270\Omega$	-	-	4	μs	
	下降时间 Fall Time	t_f		-	0.1	-	μs	
关闭时间 Turn off Time	t_{off}	-		-	4	μs		
上升时间 Rise Time	t_r	-		0.1	-	μs		
数据速率 Data Rate			-	2	-	MHz		

典型光电特性曲线 Typical Electro-Optical Characteristics Curves

Fig.1 Forward current vs Forward Voltage

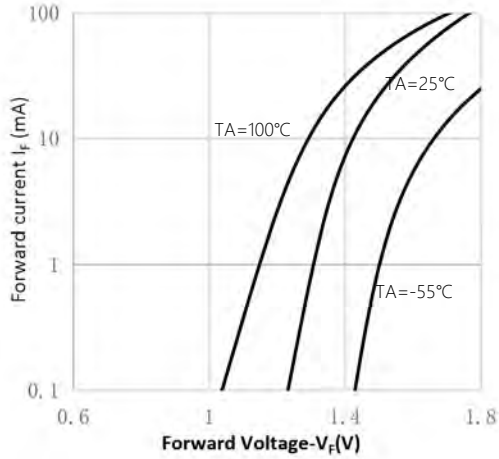

Fig.2 Transfer characteristic

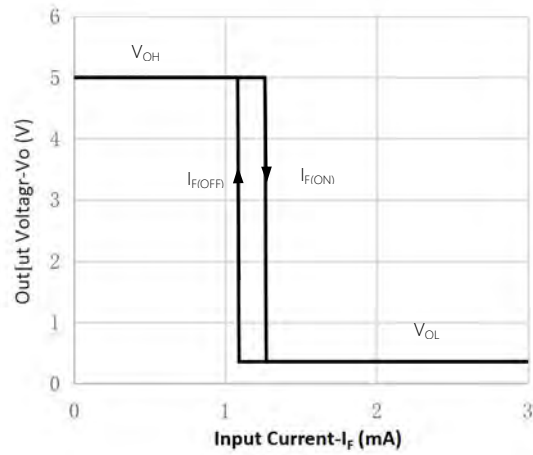

Fig.3 Turn On Threshold Current vs Supply Voltage

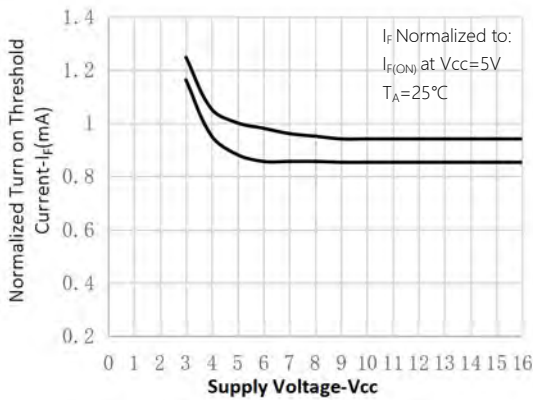

Fig.4 Turn On Threshold Current vs Ambient temperature

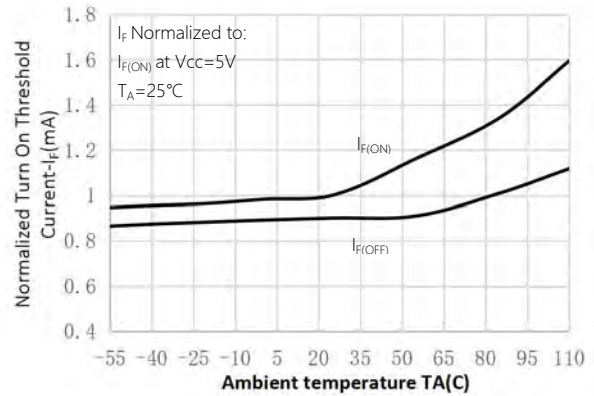

Fig.5 Low Level Output Voltage vs Load Current

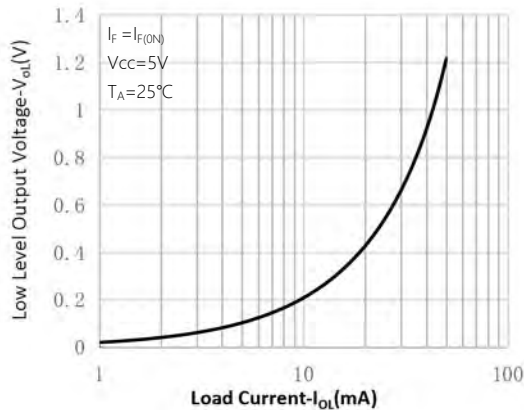
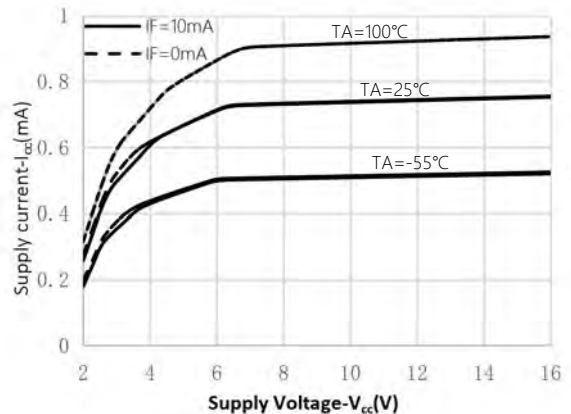
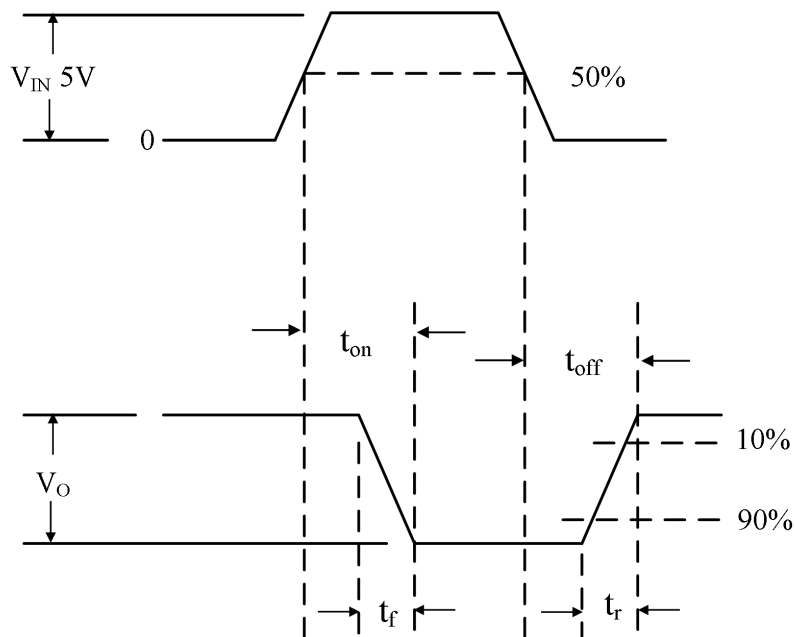
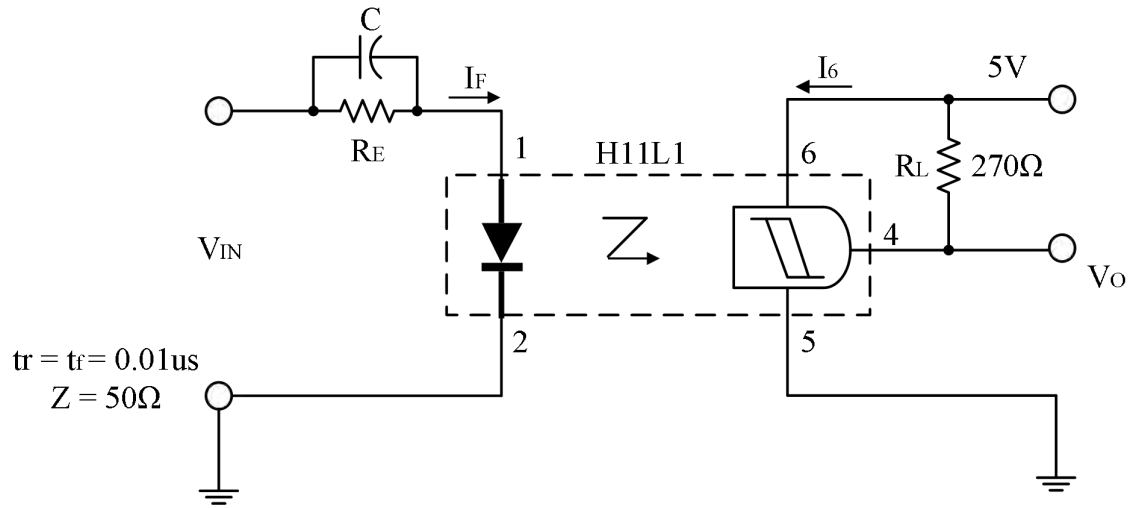

Fig.6 Supply current vs Supply Voltage



开关时间测试电路 Switching Time Test Circuit & Waveforms



外形尺寸 Outline Dimensions

DIP6

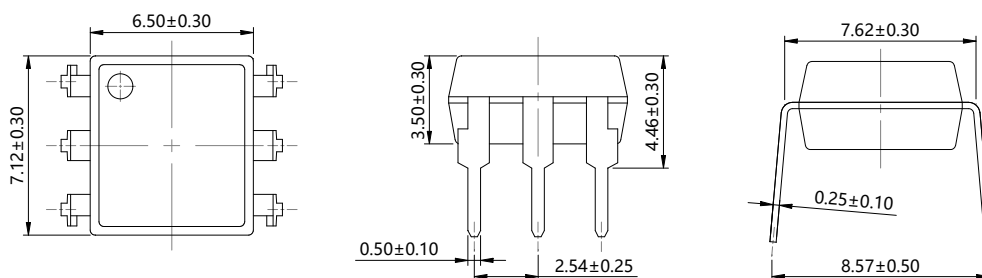

SMD6

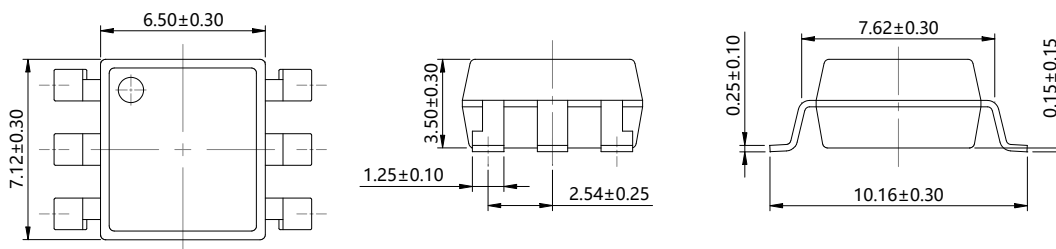

单位 Unit: mm

建议焊盘布局 Recommended Pad Layout

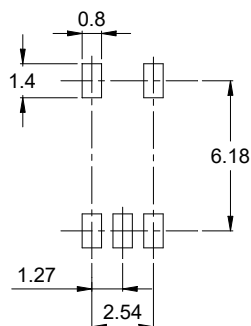

单位 Unit: mm

注：上图为产品正视图。

Note: The picture above is the front view of the product.

回流焊温度曲线图 Solder Reflow Profile

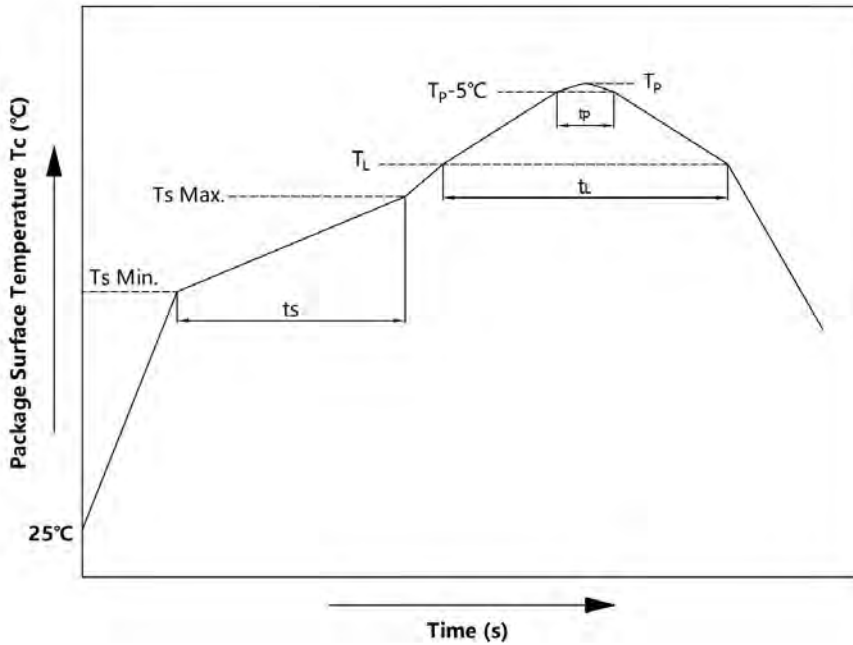

项目 Item	符号 Symbol	最小值 Min.	最大值 Max.	单位 Unit
预热温度 Preheat Temperature	T_s	150	200	$^\circ\text{C}$
预热时间 Preheat Time	t_s	60	120	s
升温速率 Ramp-Up Rate (T_L to T_P)	-	-	3	$^\circ\text{C}/\text{s}$
液相线温度 Liquidus Temperature	T_L	217		$^\circ\text{C}$
时间高于 T_L Time Above T_L	t_L	60	150	s
峰值温度 Peak Temperature	T_P	-	260	$^\circ\text{C}$
T_c 在 (T_P-5) 和 T_P 之间的时间 Time During Which T_c Is Between (T_P-5) and T_P	t_p	-	30	s
降温速率 Ramp-down Rate (T_P to T_L)	-	-	6	$^\circ\text{C}/\text{s}$

注 Note:

建议在所示的温度和时间条件下进行回流焊，最多不能超过三次；

Reflow soldering is recommended at the temperatures and times shown, no more than three times;

波峰焊温度曲线图 Wave Soldering Profile

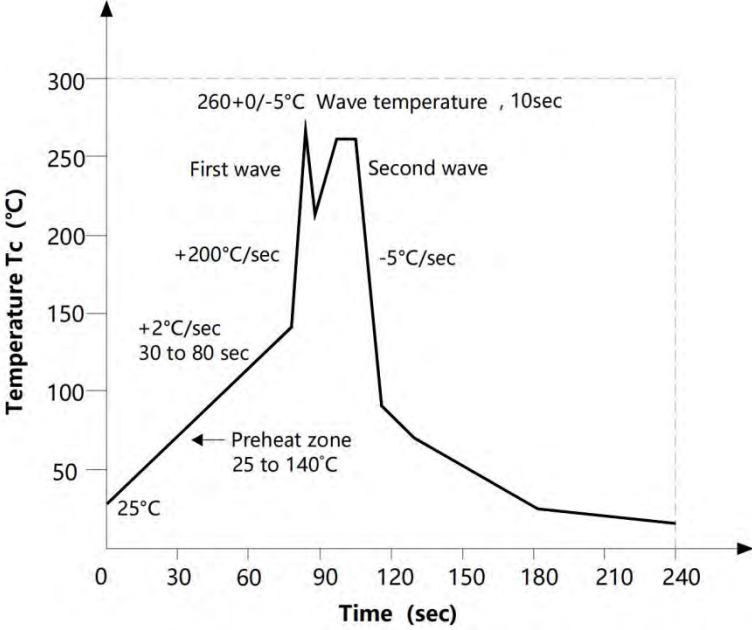

手工烙铁焊接 Soldering with hand soldering iron

- A. 手工烙铁焊仅用于产品返修或样品测试;
Hand soldering iron is only used for product rework or sample testing;
- B. 手工烙铁焊要求: 温度 360°C ± 5°C, 时间 ≤ 3s。
Hand soldering iron requirements: Temperature: 360°C ± 5°C, within 3s.

包装 Packing

■ 汇总表 Summary table

封装形式	包装方式	盘数量	盒数量	箱数量	静电袋规格	盒规格	箱(双瓦楞)规格	备注
DIP6	管装 (500*12*11mm)	65 只/管	50 管/盒	10 盒/箱	不适用	525*128*56mm	535*275*300mm	每管使用蓝白胶塞, 方向须一致
SMD6	卷盘 (φ330mm 蓝盘)	1千只/盘	2 盘/盒	10 盒/箱	450*390*0.1mm	340*60*340mm	620*360*365mm	首尾端至少空 200 毫米
Package Type	Packing Form	Quantity per Reel	Quantity per Box	Quantity per Carton	Antistatic Bag Specification	Box Specification	Carton Specification	Note
DIP6	Tube (500*12*11mm)	65 pcs/tube	50 tubes/box	10 boxes/ctn	Not applicable	525*128*56mm	535*275*300mm	Use blue and white rubber stoppers for each tube, with the same direction
SMD6	Reel (φ330mm Blue)	1k pcs/reel	2 reels/box	10 boxes /ctn	450*390*0.1mm	340*60*340mm	620*360*365mm	Guard band 200mm min.

■ 条管包装 Tube

- 1) 每箱数量: 32500 只。
Qty/ctn: 22500pcs
- 2) 内包装: Inner packing:
 - i. 每条管 65 只。
65pcs/tube
 - ii. 每盒 50 条管。
50 tubes/box
- 3) 示意图 Schematic:

■ 编带包装 Tape & Reel

- 1) 每卷数量: 1000 只。
Qty/reel: 1000 pcs.
- 2) 每箱数量: 20000 只。
Qty/ctn: 20000 pcs.
- 3) 内包装: 每盒 2 盘。
Inner packing: 2 reels/box.
- 4) 示意图 Schematic:

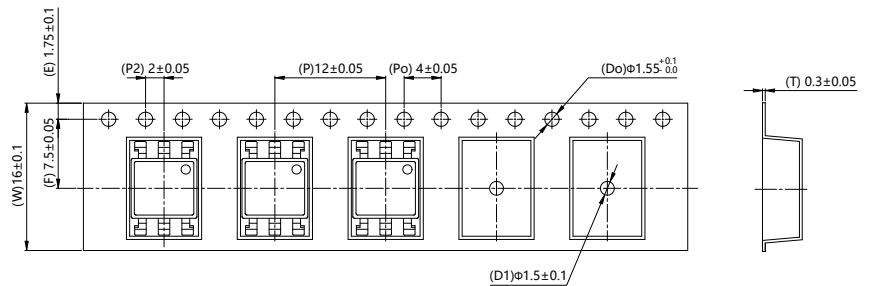
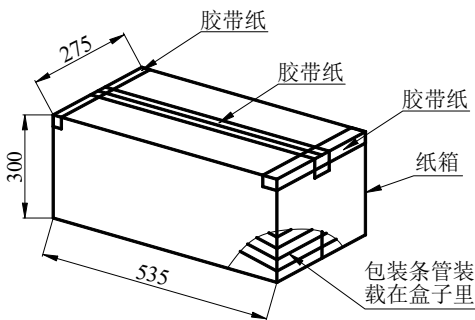

单位 Unit: mm

注意 Attention

- 美特光持续不断改进质量、可靠性、功能或设计，保留此文件更改的权利恕不另行通知。
MT continuously improve quality, reliability, function and design. We reserve the right to change this document without prior notice.
- 请遵守产品规格书使用，美特光不对使用时不符合产品规格书条件而导致的质量问题负责。
Please use in accordance with the product specification. MT is not responsible for the quality problems caused by non-compliance with the product specifications.
- 对于需要高可靠性或安全性的设备/装置需求，请联系我们的销售人员。
For equipment/devices requiring high reliability or safety, please contact our sales representatives.
- 当需要用于任何“特定”应用时，请咨询我们的销售人员。
When requiring a device for any “specific” application, please contact our sales in advice.
- 如对文件中表述的内容有疑问，欢迎联系我们。
If you have any questions about the contents of the document, please contact us.