

Shenzhen P&O Technology Co.,Limited	Rev No	Issued Date.	Page
	A	2021.10.7	1/12

Project Size.	1.69 inch	
Model No.	P169H002-CTP	
Samples No.		
Product type.	240xRGBx280 SPI mode	
Signature by customer:		
Prepared	Checked	Approved

Shenzhen P&O Technology Co.,Limited

Email: polcd@polcd.com

Mobile: 86-136 0019 7172

1.0 GENERAL DESCRIPTION

Item	Specification	Unit
Screen Size	1.69 inch	Diagonal
Number of Pixel	240RGB(H)x280(V)	Pixels
Display area	27.97(H)x32.63(V)	mm
Pixel pitch	0.11655(H)x0.11655(V)	mm
Outline Dimension	33.13x41.13x3.61	mm
Pixel arrangement	RGB Vertical Stripe	---
Display mode	Normally Black	---
Viewing Direction(eye)	ALL	---
Gray inversion direction	--	
Display Color	262K	---
Luminance(cd/m ²)	350	nit
Contrast Ratio	1000:1	---
Surface treatment	---	---
Interface	4-line SPI	
Back-light	LED Side-light type	---
Drive IC	ST7789V	
Operation Temperature	-20~70	°C
Storage Temperature	-30~80	°C
Weight	---	g

1.1 Features

- n 4-line SPI parallel interface.

1.2 Applications

- n MPOS Device.
- n Personal Navigation Device.
- n Other devices which require high quality displays.

2.0 INPUT INTERFACE PIN ASSIGNMENT

FPC connector is used for electronics interface.

PinNo.	Symbol	Function
1	GND	Ground
2	LEDK	LED back light(Cathode)
3	VDD 3.3V	Power Supply 3.3V
4	VDDIO 1.8V	Power Supply 1.8V(If there is no 1.8V, directly connect to 3.3V)
5-6	GND	Ground
7	D/C	Display data/command selection pin in parallel
8	CS	Chip select input pin
9	SCL	Serial interface clock
10	SDA	SPI interface input/output pin
11	RESET	External reset input.
12	GND	Ground
13	TP_SCL	Touch screen clock signal
14	TP_SDA	Touch data input/output bidirectional pins
15	TP_TRST	Touch screen reset signal
16	TP_TINT	Touch screen interrupt signa
17	VDD 3.3V	Touch screen power supply
18	GND	Ground

3.0 OPTICAL CHARACTERISTICS

3.1 Optical specification

Item	Symbol	Condition	Min	Type	Max	Unit	Note
White luminance (Center)	Lv	$\Theta=0$ Normal Viewing Angle $I_{BL}=60mA$	--	350	--	cd/m ²	(4)(5)(7)
Response time	Tr+Tf		--	35	45	ms	(3)
Contrast ratio	CR		800	1000	--	--	(2)(4)
Color Chromaticity (CIE1931)	white		Wx	--	0.323	--	
		Wy	--	0.347	--		
Viewing Angle	Hor	Θ_L	70	80	--		(1)
		Θ_R	70	80	--		
	Ver	Θ_U	70	80	--		
		Θ_D	70	80	--		
Brightness uniformity	Avg	$\Theta=0$	80	90	--	%	(5)
Color Gamut	NTSC	$\Theta=0$	--	70	--	%	(6)
Optima View Direction	ALL						(1)

3.2 Measuring Condition

- n Measuring surrounding: dark room
- n LED current IL: 60mA
- n Ambient temperature: $25 \pm 2^\circ C$
- n 15min. warm-up time

3.3 Measuring Equipment

- n BM-7
- n Measuring spot size: 30 ~ 31 mm

Rev No	Issued Date.	Page
A	2021.10.7	5/12

Note (1) Definition of Viewing Angle

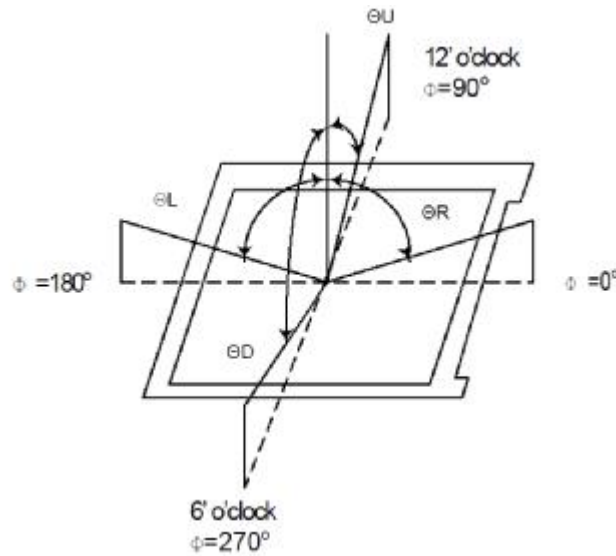

Note (2) Definition of Contrast Ratio(CR):

Measured at the center point of panel

$$CR = \frac{\text{Luminance with all pixels white}}{\text{Luminance with all pixels black}}$$

Note (3) Definition of Response Time: Sum of TR and TF

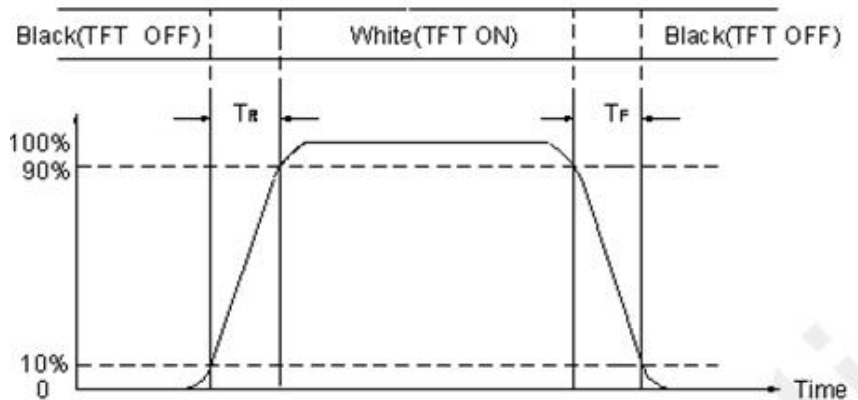

Note (4) Definition of optical measurement setup

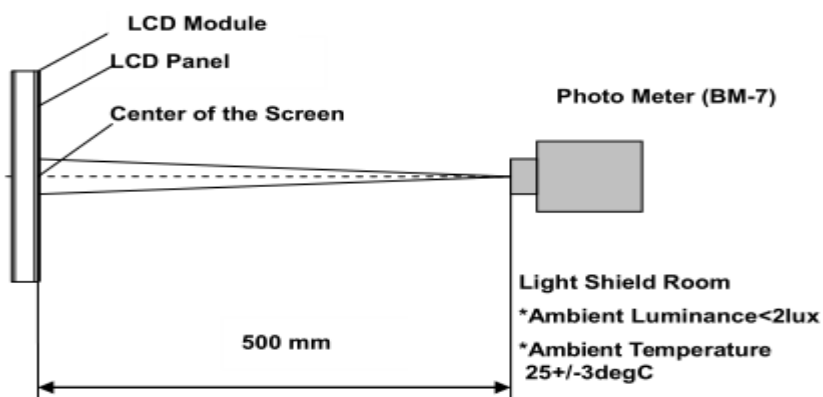

Note (5) Definition of brightness uniformity

The luminance uniformity is calculated by using following formula.

$$\Delta B_p = B_p (\text{Min.}) / B_p (\text{Max.}) \times 100 (\%)$$

$B_p (\text{Max.})$ = Maximum brightness in 9 measured spots

$B_p (\text{Min.})$ = Minimum brightness in 9 measured spots .

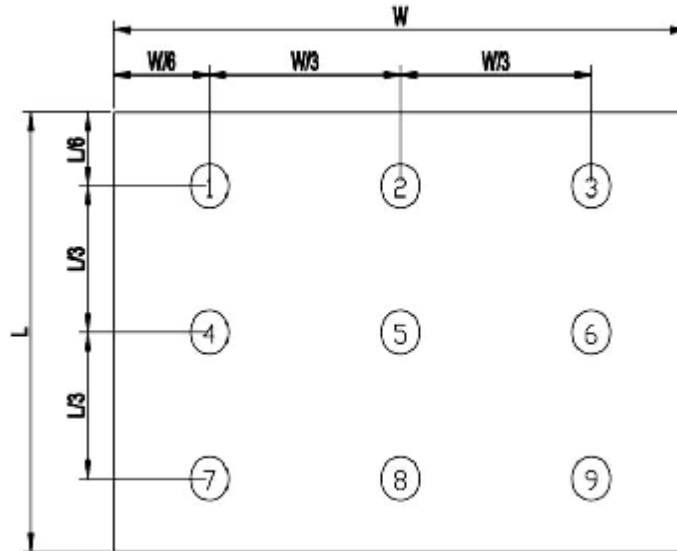

Note (6) Definition of Color of CIE1931 Coordinate and NTSC Ratio.

Color gamut:

$$S = \frac{\text{Area of RGB triangle}}{\text{Area of NTSC triangle}} \times 100\%$$

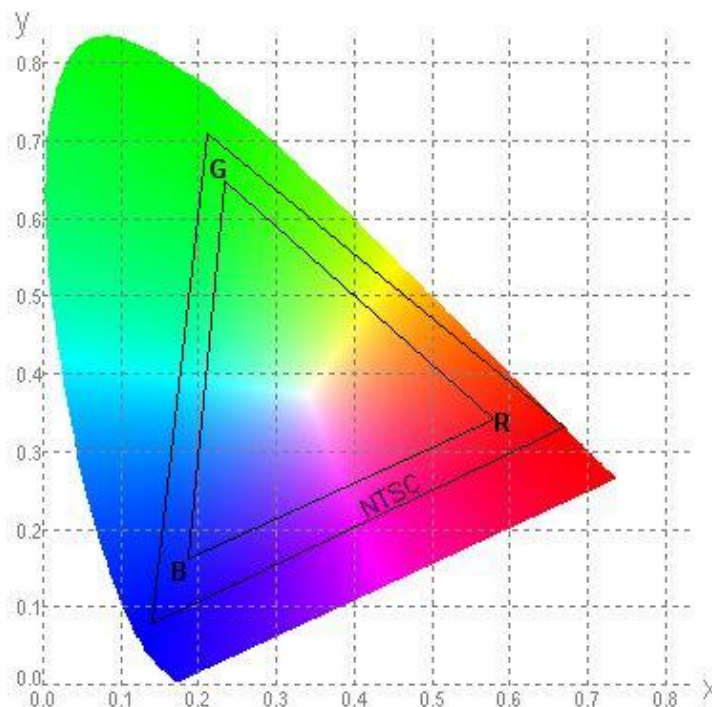

Note (7) Measured the luminance of white state at center point.

4.0 ELECTRICAL CHARACTERISTICS

4.1 TFT LCD Module

Item	Symbol	Min.	Typ.	Max.	Unit	Remark
Analog supply voltage	VDD	2.4	2.8	3.3	V	
Digital supply voltage	VDDI	1.65	1.8	3.3		
Input signal Voltage	VIH	0.7VDDI	-	VDDI	V	
	VIL	GND	-	0.3VDDI	V	

4.2 Back-Light Unit

The backlight system is an edge-lighting type with 3 LED Dies.

The characteristics of the LED are shown in the following tables.

Item	Symbol	Min	Typ	Max	Unit	Note
LED current	IL	-	45	60	mA	(2)
LED voltage	VL	-	2.8	3.0	V	
Operating LED life time	Hr	-	20000	15000	Hour	(1)(2)

Note (1) LED life time (Hr) can be defined as the time in which it continues to operate under the condition: $T_a=25\pm 3\text{ }^\circ\text{C}$, typical IL value indicated in the above table until the brightness becomes less than 50%.

Note (2) The "LED life time" is defined as the module brightness decrease to 50% original brightness at $T_a=25^\circ\text{C}$ and $IL=60\text{mA}$. The LED lifetime could be decreased if operating IL is larger than 100mA. The constant current driving method is suggested.

4.3 Back-light brightness control circuit reference

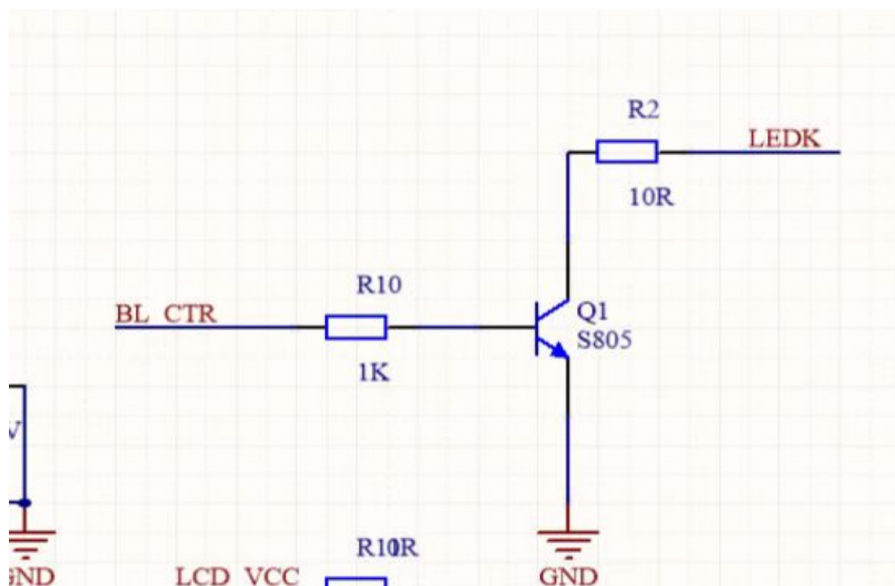

5.0 Reliability conditions

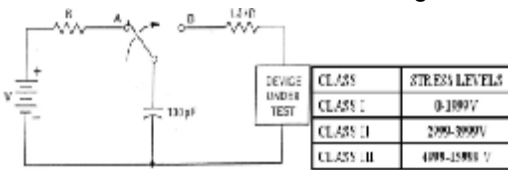
NO	Item	Conditions	Notes
1	High Temperature Storage	Ta=80°C ± 2°C, 72hrs	
2	Low Temperature Storage	Ta=-30°C ± 2°C, 72hrs	
3	High Temperature Operation	Ta=70°C ± 2°C, 72hrs(Operation state)	
4	Low Temperature Operation	Ta=-20°C ± 2°C, 72hrs(Operation state)	
5	High Temperature and High Humidity (Storage)	Ta=+60°C, 90%RH, 72hrs	
6	Thermal Cycling Test (non operation)	-20°C (30min) → +70°C (30min), 10cycles	
7	Electro static Discharge	Human Body Mode 100pF ± 10%/1500 Ω ± 1% Air ± 8kV / contact ± 6kV Consecutive 10times/ Each discharge 	
8	Vibration test(with carton)	Total fixed amplitude:15mm Vibration Frequency :10~55Hz One cycle 60 seconds to 3 directions of X,Y,Z for Each 15 minutes	
9	Drop (with carton)	Height: 60cm 1 corner, 3 edges, 6 surfaces	

Note: There is no display function NG issue occurred, all the cosmetic specification is judged before the reliability stress.

Rev No	Issued Date.	Page
A	2021.10.7	9/12

6.0 OUTLINE DIMENSION

NOTES:

1. DISPLAY TYPE: 1.69" TFT
2. VIEWING DIRECTION: All
3. POLARIZER MODE: TRANSMISSIVE/NORMALLY BLACK
4. DRIVER IC: ST7789V
5. OPERATING TEMP.: -20° C~70° C
6. STORAGE TEMP.: -30° C~80° C
7. BACK LIGHT: 2CHTP-WHITE LED; 40MA, 3.0V
8. LCM Luminance: 350 CD/M2 (TYP)
9. UNMARKED TOLERANCE: ±0.2
10. 建议机壳开窗可视区比 LCD A.A区单边大 0.4mm
11. 产品符合ROHS标准

四线一通道

Pin	DESCRIPTION
1	GND
2	LEK
3	VDD 3.3V
4	VDDIO 1.8V
5	GND
6	GND
7	D/C
8	CS
9	SCL
10	SDA
11	RESET
12	GND
13	TP_SCL
14	TP_SDA
15	TP_TRST
16	TP_TINT
17	VDD 3.3V
18	GND

Top View Dimensions:

- Total Width: 41.13 ± 0.05(TP)
- Inner Width: 37.42 ± 0.2(BL)
- Inner Width: 37.13 ± 0.2(LCD)
- Inner Width: 34.83 ± 0.2(LCD)
- Inner Width: 34.43 ± 0.2(POL)
- Inner Width: 33.43 (V.A)
- Inner Width: 32.63 (A.A)
- Right Margin: 5.23
- Right Margin: 1.17
- Right Margin: 1.05
- Right Margin: 0.65
- Right Margin: 1.56 ± 0.1
- Right Margin: 3.61
- Right Margin: 57.9 ± 0.05 (功能片)
- Right Margin: 60.0 ± 0.1 (ID+OD)

Bottom View Dimensions:

- Bottom Width: 22.67
- Bottom Margin: 2.8
- Bottom Margin: 0.35
- Bottom Margin: 8.5
- Bottom Margin: 0.5
- Bottom Margin: 4.5

Other Labels:

- 1.69" (Diagonal)
- 240*RGB*280 (Resolution)
- 银焊点 (Solder points)
- IC区域 (IC Area)
- DATA SIGNAL (Data Signal)
- LED CIRCUIT DIAGRAM (LED Circuit Diagram)
- 胶铁一体化(白色塑胶) (White plastic integrated with metal)

注意FPC+PI补强= 0.3 ± 0.03

IC: CST816T

Customer Approval

Signature: _____

Shenzhen P&O Technology Co., Limited

P169H002-CTP

Unit: mm

General Roughness: $\sqrt{0.3}$

Tolerance: ± 0.3

Dimension: ± 1

Angle: ± 1

By: Jayson

Date: 20210619

Material: Soda Lime / Polyimide

Scale: 1:1

Sheet: 1 of 1

Size: A3

Item	Date	Remark
A	20210619	Original Drawing

7.0 Items and Criteria:

7.1 Guarantee

APEX warrants the quality of our products for **1 year** (from the date of delivery). If there are functional defects found during the period of warranty, the defective products would be replaced on a one-to-one basis. Apex would not be responsible for any direct /indirect liabilities consequential to any parties.

All the products should be stored or used as specified conditions described in these sheets. If module productions are not stored or used as specified conditions, herein, it will be void the **1 year** warranty(guarantee).

7.2 Visual inspection criterion in cosmetic

(1) Glass defect

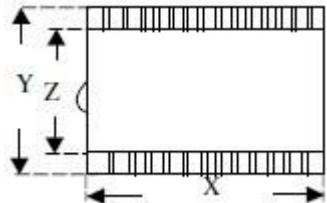
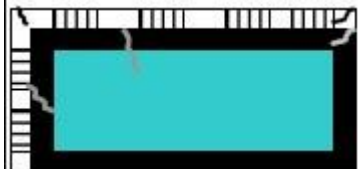
Glass defect			
NO	Defect	Criteria	Remark
1	Dimension(Minor)	By engineering diagram	
2	Cracks(Major)	Extensive crack 【Reject】	

(2) LCM appearance defect

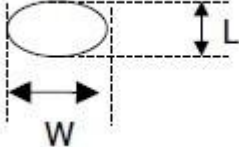
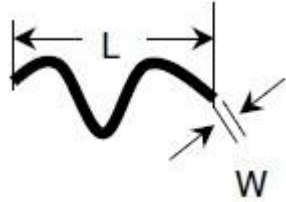
NO	Defect	Criteria		Remark
1	Round type(Minor)	Spec	Permissible Qty	1. $\psi = (L+W)/2$, L: Length, W: Width 2. Disregard if out of A.A. 
		$\psi \leq 0.10\text{mm}$	Disregard	
		$0.10\text{mm} < \psi \leq 0.20\text{mm}$	3	
		$0.20\text{mm} < \psi$	0	
2	Line type(Minor)	Spec	Permissible Qty	1. L: Length, W: Width 2. Disregard if out of A.A. 
		$W \leq 0.03\text{mm}$	Disregard	
		$L \leq 3.0\text{mm}$ and $0.03\text{mm} < W \leq 0.05\text{mm}$	2	
		$L \leq 3.0\text{mm}$ and $0.05\text{mm} < W \leq 0.10\text{mm}$	1	
		$W > 0.10\text{mm}$ or $L > 3.0\text{mm}$	0	
3		Spec.	Permissible Qty	1. $\psi = (L+W)/2$, L: Length, W: Width

	Polarizer dent(Minor)	$\psi \leq 0.20\text{mm}$	Disregard	2.Disregard if out of A.A.
		$0.20\text{mm} < \psi \leq 0.30\text{mm}$	2	
		$0.30\text{mm} < \psi \leq 0.50\text{mm}$	1	

(3) FPC

NO	Defect	Criteria	Remark
1	Copper peeling(Minor)	Copper peeling 【Reject】	
2	Golden finger	FPC golden finger broken, dead fold, indentation makes FPC surface broken 【Reject】 Tin plating layer(or gold plating) scratch, but not hurt circuit 【Accept】 Except circuit, other position scratch but not expose metal wire 【Accept】	
3	Pin	FPC PI layer delamination 【Reject】 Material and color are inconsistent with sample, FPC burrs 【Reject】 FPC Pin deformation but not affect function. 【Accept】 FPC Pin area is dirty 【Reject】 Other than FPC Pin area is dirty but not affect function 【Accept】	
4	Golden finger	Golden finger edge has burrs, foreign material 【Reject】 Golden finger oxidation (dark), uneven electroplating, pinhole, foreign material 【Reject】 Golden finger soldering pad crack exceeds 1/3 length of soldering pad, and soldering pad crack exceed 2 Pins 【Reject】 Golden finger tin plating(or gold plating)scratch, but not hurt circuit 【Accept】 Other than golden finger area scratch but not expose metal circuit 【Accept】	
5	FPC Silk printing	Ghosting, incomplete silk printing, wrong printing 【Reject】	
6	FPC Circuit line width	Line width deviation exceed 1/3 line width 【Reject】	



(4) Black tape

NO	Defect	Criteria	Remark
1	Shift(Minor)	IC exposed 【Reject】	
2	No black tape(Minor)	No black tape 【Reject】	

(5) Silicon

NO	Defect	Criteria	Remark
1	Amount of silicon (Minor)	ITO exposed 【Reject】	

7.3 Visual inspection criterion in electrical display

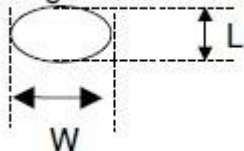
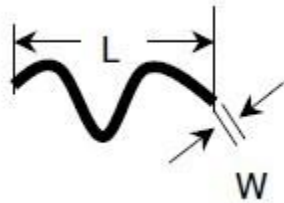
NO	Defect	Criteria		Remark
1	No display (Major)	Not allowed		
2	Missing line (Major)	Not allowed		
3	Darker or lighter Line (Major)	Not allowed		
4	Weak line(Major)	By limited sample		
5	Bright / Dark point (Minor)	Spec.	Permissible Qty	1:1sub-pixel: 1R or 1G or1B 2:Point defect area $\geq 1/2$ sub pixel.
		Bright point	1	
		Dark point	2	
6	Round type (Minor)	Spec	Permissible Qty	1. $\psi=(L+W)/2$, L: Length, W: Width 2. Disregard if out of A.A. 
		$\psi \leq 0.10\text{mm}$	Disregard	
		$0.10\text{mm} < \psi \leq 0.20\text{mm}$	3	
		$0.20\text{mm} < \psi$	0	
7	Line type (Minor)	Spec.	Permissible Qty	1. L: Length, W: Width 2. Disregard if out of A.A. 
		$W \leq 0.03\text{mm}$	Disregard	
		$L \leq 3.0\text{mm}$ and $0.03\text{mm} < W \leq 0.05\text{mm}$	2	
		$L \leq 3.0\text{mm}$ and $0.05\text{mm} < W \leq 0.10\text{mm}$	1	
		$W > 0.10\text{mm}$ or $L > 3.0\text{mm}$	0	
8	Mura (Minor)	By 5% ND filter invisible		