

# NCP115

## LDO Regulator - High PSRR

### 300 mA

The NCP115 is 300 mA LDO that provides the engineer with a very stable, accurate voltage with low noise suitable for space constrained, noise sensitive applications. In order to optimize performance for battery operated portable applications, the NCP115 employs the dynamic quiescent current adjustment for very low  $I_Q$  consumption at no-load.

#### Features

- Operating Input Voltage Range: 1.7 V to 5.5 V
- Available in Fixed Voltage Options: 0.8 V to 3.6 V Contact Factory for Other Voltage Options
- Very Low Quiescent Current of Typ. 50  $\mu$ A
- Soft Start Feature with Two  $V_{OUT}$  Slew Rate Speed
- Standby Current Consumption: Typ. 0.1  $\mu$ A
- Low Dropout: 250 mV Typical at 300 mA @ 2.8 V
- $\pm 1\%$  Accuracy at Room Temperature
- High Power Supply Ripple Rejection: 70 dB at 1 kHz
- Thermal Shutdown and Current Limit Protections
- Available in XDFN4 and TSOP-5 Packages
- Stable with a 1  $\mu$ F Ceramic Output Capacitor
- These are Pb-Free Devices

#### Typical Applications

- PDAs, Mobile phones, GPS, Smartphones
- Wireless Handsets, Wireless LAN, Bluetooth<sup>®</sup>, Zigbee<sup>®</sup>
- Portable Medical Equipment
- Other Battery Powered Applications

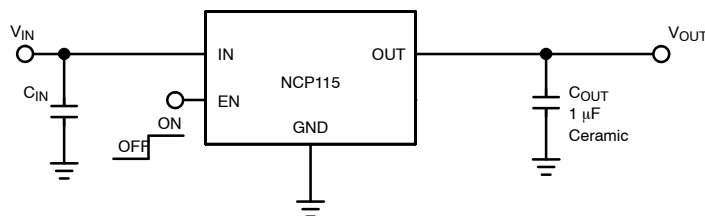

Figure 1. Typical Application Schematic



ON Semiconductor<sup>®</sup>

[www.onsemi.com](http://www.onsemi.com)

#### MARKING DIAGRAMS



**XDFN4**  
**CASE 711AJ**

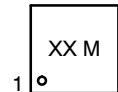

XX = Specific Device Code  
M = Date Code



**TSOP-5**  
**CASE 483**

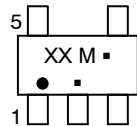

XX = Device Code  
M = Date Code\*  
▪ = Pb-Free Package

(Note: Microdot may be in either location)  
\*Date Code orientation and/or position may vary depending upon manufacturing location.

#### PIN CONNECTIONS

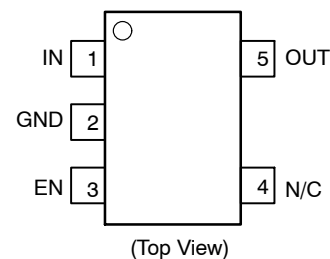
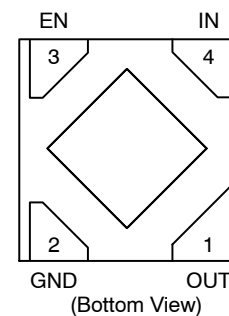

#### ORDERING INFORMATION

See detailed ordering, marking and shipping information on page 15 of this data sheet.

# NCP115



\*Active output discharge function is present only in NCP115A and NCP115C devices.  
yyy denotes the particular  $V_{OUT}$  option.

**Figure 2. Simplified Schematic Block Diagram**

## PIN FUNCTION DESCRIPTION

| Pin No. (XDFN4) | Pin No. (TSOP5) | Pin Name | Description  |
|-----------------|-----------------|----------|--|
| 1               | 5               | OUT      | Regulated output voltage pin. A small ceramic capacitor with minimum value of 1 $\mu$ F is needed from this pin to ground to assure stability. |
| 2               | 2               | GND      | Power supply ground.   |
| 3               | 3               | EN       | Driving EN over 0.9 V turns on the regulator. Driving EN below 0.4 V puts the regulator into shutdown mode.                                    |
| 4               | 1               | IN       | Input pin. A small capacitor is needed from this pin to ground to assure stability.  |
| -               | 4               | N/C      | Not connected. This pin can be tied to ground to improve thermal dissipation.  |
| -               | -               | EPAD     | Exposed pad should be connected directly to the GND pin. Soldered to a large ground copper plane allows for effective heat removal.            |

## ABSOLUTE MAXIMUM RATINGS

| Rating                                    | Symbol       | Value                             | Unit         |
|---|--------------|-----------------------------------|--------------|
| Input Voltage (Note 1)                    | $V_{IN}$     | -0.3 V to 6 V                     | V            |
| Output Voltage                            | $V_{OUT}$    | -0.3 V to $V_{IN} + 0.3$ V or 6 V | V            |
| Enable Input                              | $V_{EN}$     | -0.3 V to 6 V                     | V            |
| Output Short Circuit Duration             | $t_{SC}$     | $\infty$                          | s            |
| Maximum Junction Temperature              | $T_{J(MAX)}$ | 150                               | $^{\circ}$ C |
| Storage Temperature                       | $T_{STG}$    | -55 to 150                        | $^{\circ}$ C |
| ESD Capability, Human Body Model (Note 2) | $ESD_{HBM}$  | 2000                              | V            |
| ESD Capability, Machine Model (Note 2)    | $ESD_{MM}$   | 200                               | V            |

Stresses exceeding those listed in the Maximum Ratings table may damage the device. If any of these limits are exceeded, device functionality should not be assumed, damage may occur and reliability may be affected.

- Refer to ELECTRICAL CHARACTERISTICS and APPLICATION INFORMATION for Safe Operating Area.
- This device series incorporates ESD protection and is tested by the following methods:  
ESD Human Body Model tested per EIA/JESD22-A114,  
ESD Machine Model tested per EIA/JESD22-A115,  
Latchup Current Maximum Rating tested per JEDEC standard: JESD78.

## THERMAL CHARACTERISTICS (Note 3)

| Rating   | Symbol          | Value | Unit           |
|--|-----------------|-------|----------------|
| Thermal Characteristics, XDFN4 1x1 mm<br>Thermal Resistance, Junction-to-Air | $R_{\theta JA}$ | 208   | $^{\circ}$ C/W |
| Thermal Characteristics, TSOP-5<br>Thermal Resistance, Junction-to-Air       | $R_{\theta JA}$ | 162   | $^{\circ}$ C/W |

- Single component mounted on 1 oz, FR 4 PCB with 645 mm<sup>2</sup> Cu area.

# NCP115

**ELECTRICAL CHARACTERISTICS**  $-40^{\circ}\text{C} \leq T_J \leq 85^{\circ}\text{C}$ ;  $V_{IN} = V_{OUT(NOM)} + 1\text{ V}$  for  $V_{OUT}$  options greater than 1.5 V. Otherwise  $V_{IN} = 2.5\text{ V}$ , whichever is greater;  $I_{OUT} = 1\text{ mA}$ ,  $C_{IN} = C_{OUT} = 1\text{ }\mu\text{F}$ , unless otherwise noted.  $V_{EN} = 0.9\text{ V}$ . Typical values are at  $T_J = +25^{\circ}\text{C}$ . Min./Max. are for  $T_J = -40^{\circ}\text{C}$  and  $T_J = +85^{\circ}\text{C}$  respectively (Note 4).

| Parameter   | Test Conditions   |                             | Symbol                       | Min | Typ  | Max | Unit                |
|---|---|-----------------------------|------------------------------|-----|------|-----|---------------------|
| Operating Input Voltage                                     |   |                             | $V_{IN}$                     | 1.7 |      | 5.5 | V                   |
| Output Voltage Accuracy                                     | $-40^{\circ}\text{C} \leq T_J \leq 85^{\circ}\text{C}$                                | $V_{OUT} \leq 2.0\text{ V}$ | $V_{OUT}$                    | -40 |      | +40 | mV                  |
|   |   | $V_{OUT} > 2.0\text{ V}$    |                              | -2  |      | +2  | %                   |
| Line Regulation   | $V_{OUT} + 0.5\text{ V} \leq V_{IN} \leq 5.5\text{ V}$ ( $V_{IN} \geq 1.7\text{ V}$ ) |                             | $\text{Reg}_{LINE}$          |     | 0.01 | 0.1 | %/V                 |
| Load Regulation – XDFN4 package                             | $I_{OUT} = 1\text{ mA}$ to 300 mA   |                             | $\text{Reg}_{LOAD}$          |     | 12   | 30  | mV                  |
| Load Regulation – TSOP-5 package                            |   |                             |                              |     | 28   | 45  |                     |
| Dropout Voltage – XDFN4 package (Note 5)                    | $I_{OUT} = 300\text{ mA}$   | $V_{OUT} = 1.8\text{ V}$    | $V_{DO}$                     |     | 425  | 560 | mV                  |
|   |   | $V_{OUT} = 2.8\text{ V}$    |                              |     | 250  | 320 |                     |
|   |   | $V_{OUT} = 3.3\text{ V}$    |                              |     | 215  | 260 |                     |
| Dropout Voltage – TSOP-5 package (Note 5)                   | $I_{OUT} = 300\text{ mA}$   | $V_{OUT} = 1.8\text{ V}$    | $V_{DO}$                     |     | 445  | 580 | mV                  |
|   |   | $V_{OUT} = 2.8\text{ V}$    |                              |     | 270  | 340 |                     |
|   |   | $V_{OUT} = 3.3\text{ V}$    |                              |     | 235  | 280 |                     |
| Output Current Limit  | $V_{OUT} = 90\% V_{OUT(nom)}$   |                             | $I_{CL}$                     | 300 | 600  |     | mA                  |
| Quiescent Current   | $I_{OUT} = 0\text{ mA}$   |                             | $I_Q$                        |     | 50   | 95  | $\mu\text{A}$       |
| Shutdown Current  | $V_{EN} \leq 0.4\text{ V}$ , $V_{IN} = 5.5\text{ V}$                                  |                             | $I_{DIS}$                    |     | 0.01 | 1   | $\mu\text{A}$       |
| EN Pin Threshold Voltage<br>High Threshold<br>Low Threshold | $V_{EN}$ Voltage increasing<br>$V_{EN}$ Voltage decreasing                            |                             | $V_{EN\_HI}$<br>$V_{EN\_LO}$ | 0.9 |      | 0.4 | V                   |
| $V_{OUT}$ Slew Rate (Note 6)                                | $V_{OUT} = 3.3\text{ V}$ , $I_{OUT} = 10\text{ mA}$                                   | Normal (version A and B)    | $V_{OUT\_SR}$                |     | 190  |     | mV/ $\mu\text{s}$   |
|   |   | Slow (version C and D)      |                              |     | 20   |     |                     |
| EN Pin Input Current  | $V_{EN} = 5.5\text{ V}$   |                             | $I_{EN}$                     |     | 0.3  | 1.0 | $\mu\text{A}$       |
| Power Supply Rejection Ratio                                | $V_{IN} = 3.8\text{ V}$ , $V_{OUT} = 3.5\text{ V}$<br>$I_{OUT} = 10\text{ mA}$        | $f = 1\text{ kHz}$          | PSRR                         |     | 70   |     | dB                  |
| Output Noise Voltage  | $f = 10\text{ Hz}$ to 100 kHz   |                             | $V_N$                        |     | 70   |     | $\mu\text{V}_{rms}$ |
| Thermal Shutdown Temperature                                | Temperature increasing from $T_J = +25^{\circ}\text{C}$                               |                             | $T_{SD}$                     |     | 160  |     | $^{\circ}\text{C}$  |
| Thermal Shutdown Hysteresis                                 | Temperature falling from $T_{SD}$   |                             | $T_{SDH}$                    |     | 20   |     | $^{\circ}\text{C}$  |
| Active Output Discharge Resistance                          | $V_{EN} < 0.4\text{ V}$ , Version A and C only  |                             | $R_{DIS}$                    |     | 100  |     | $\Omega$            |

Product parametric performance is indicated in the Electrical Characteristics for the listed test conditions, unless otherwise noted. Product performance may not be indicated by the Electrical Characteristics if operated under different conditions.

4. Performance guaranteed over the indicated operating temperature range by design and/or characterization. Production tested at  $T_J = T_A = 25^{\circ}\text{C}$ . Low duty cycle pulse techniques are used during testing to maintain the junction temperature as close to ambient as possible.
5. Characterized when  $V_{OUT}$  falls 100 mV below the regulated voltage at  $V_{IN} = V_{OUT(NOM)} + 1\text{ V}$ .
6. Please refer OPN to determine slew rate. NCP115A, NCP115B – Normal speed. NCP115C, NCP115D – slower speed

TYPICAL CHARACTERISTICS

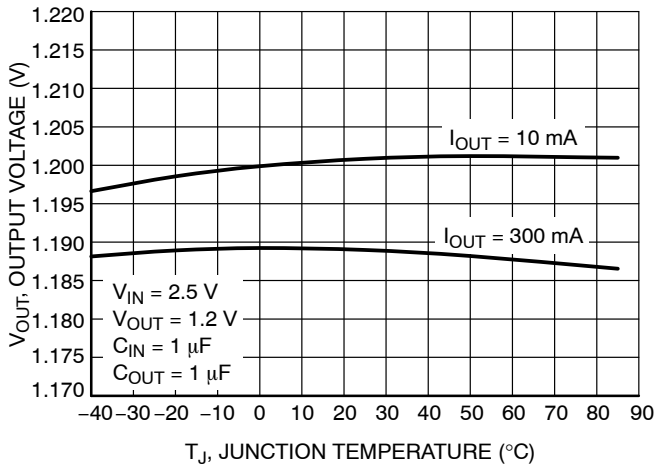

Figure 3. Output Voltage vs. Temperature -  $V_{OUT} = 1.2\text{ V}$  - XDFN4

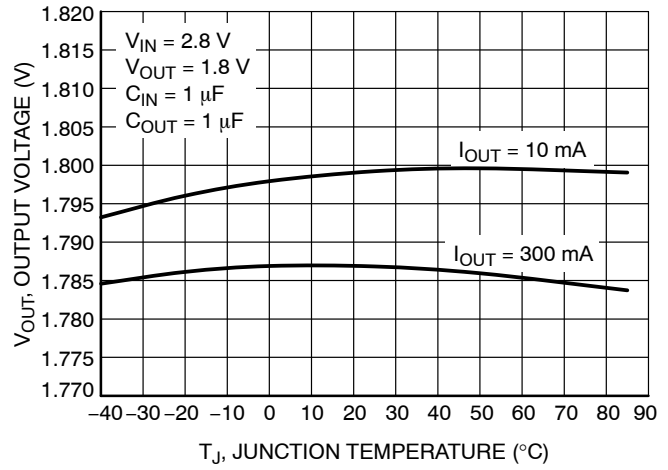

Figure 4. Output Voltage vs. Temperature -  $V_{OUT} = 1.8\text{ V}$  - XDFN4

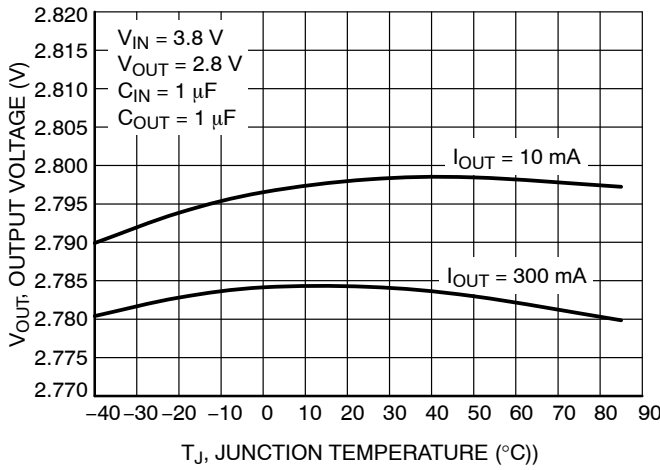

Figure 5. Output Voltage vs. Temperature -  $V_{OUT} = 2.8\text{ V}$  - XDFN4

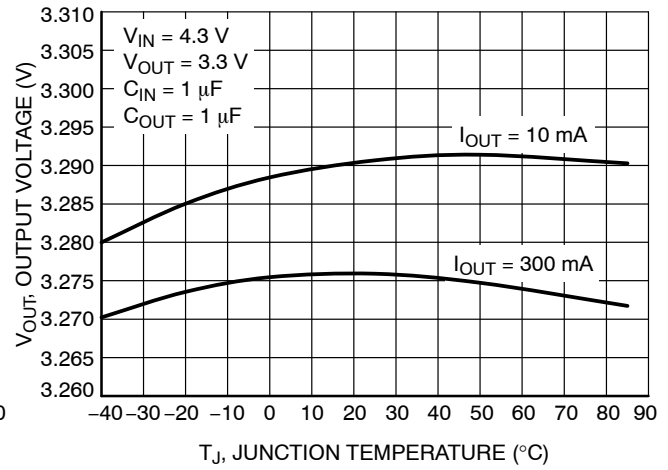

Figure 6. Output Voltage vs. Temperature -  $V_{OUT} = 3.3\text{ V}$  - XDFN4

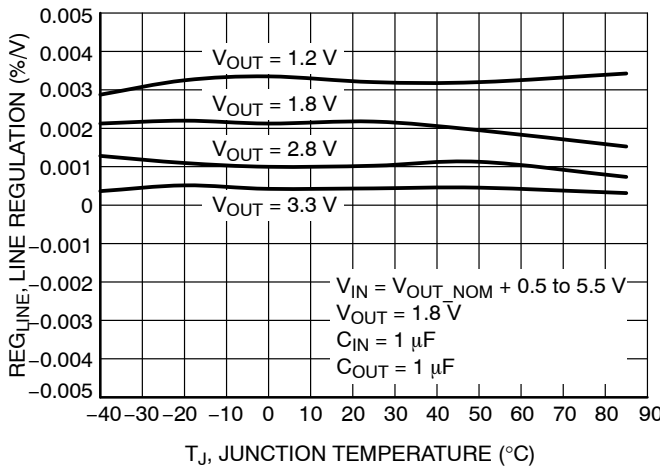

Figure 7. Line Regulation vs. Temperature

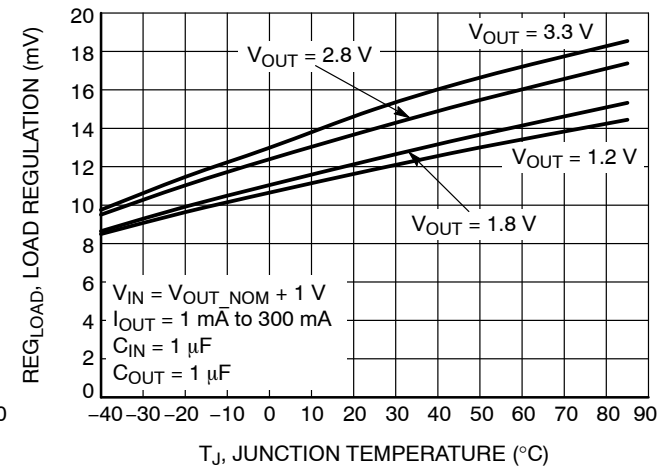

Figure 8. Load Regulation vs. Temperature - XDFN4

TYPICAL CHARACTERISTICS

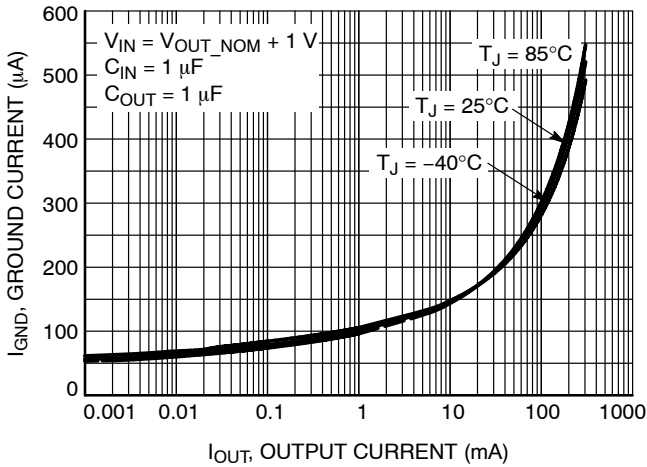

Figure 9. Ground Current vs. Load Current



Figure 10. Quiescent Current vs. Input Voltage  
V<sub>OUT</sub> = 1.8 V

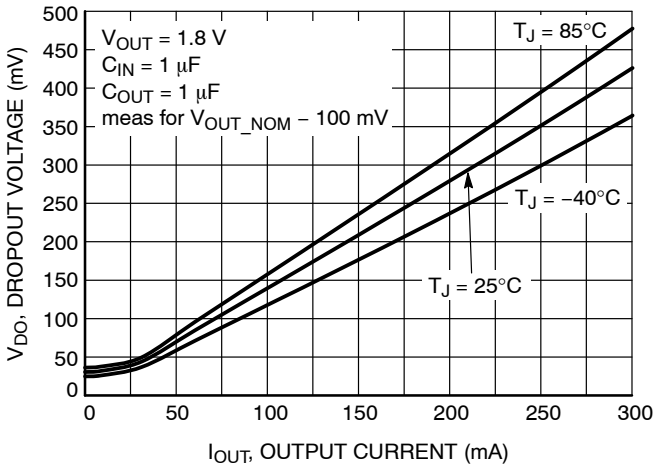

Figure 11. Dropout Voltage vs. Load Current -  
V<sub>OUT</sub> = 1.8 V



Figure 12. Dropout Voltage vs. Load Current -  
V<sub>OUT</sub> = 2.8 V

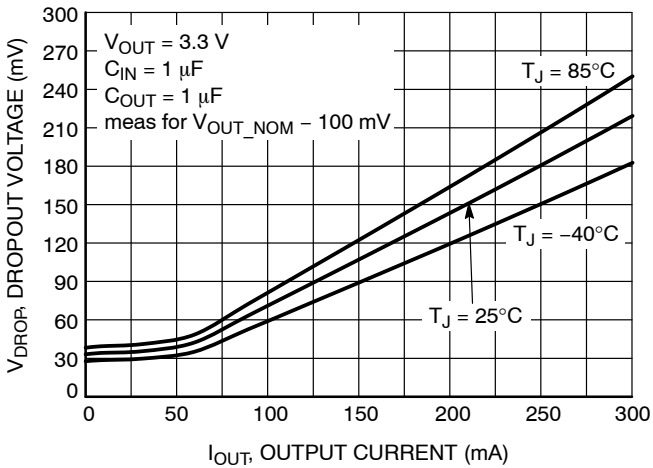

Figure 13. Dropout Voltage vs. Load Current -  
V<sub>OUT</sub> = 3.3 V

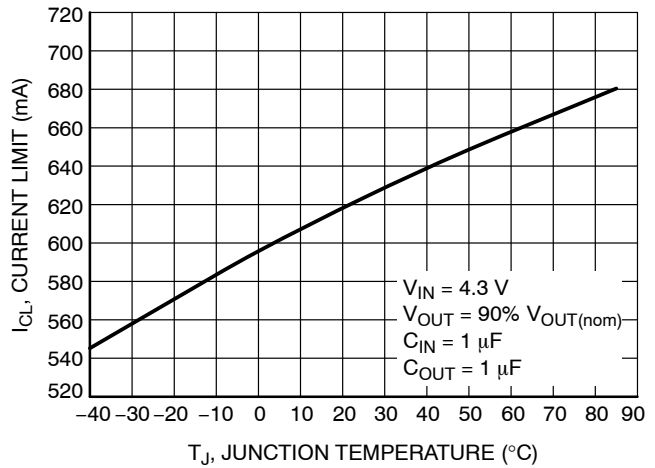

Figure 14. Current Limit vs. Temperature

TYPICAL CHARACTERISTICS

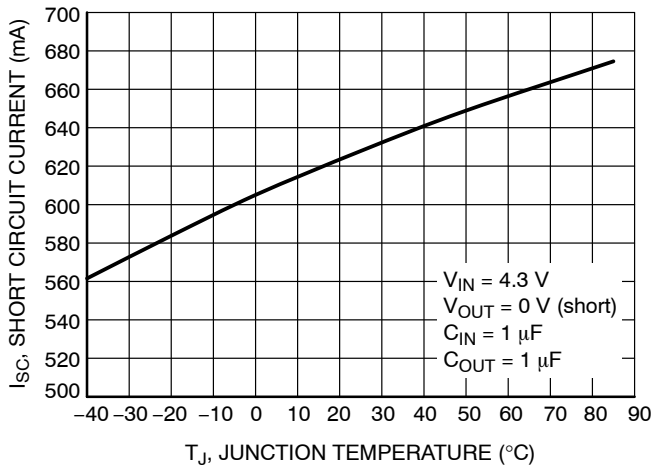

Figure 15. Short Circuit Current vs. Temperature



Figure 16. Enable Thresholds Voltage

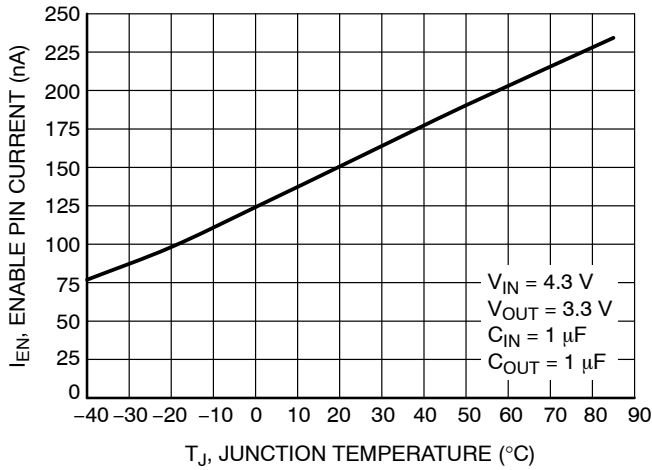

Figure 17. Current to Enable Pin vs. Temperature

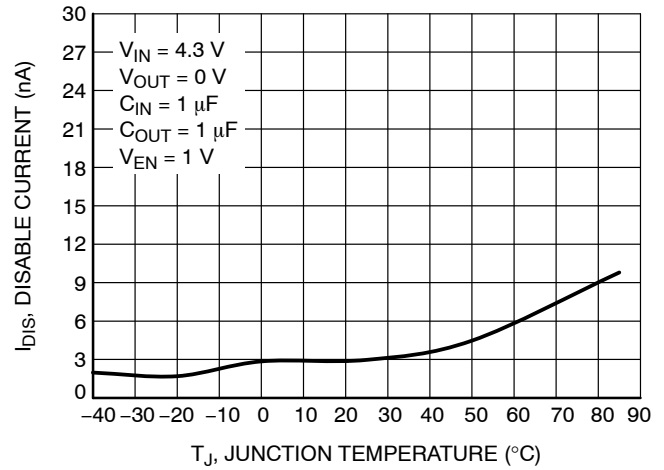

Figure 18. Disable Current vs. Temperature

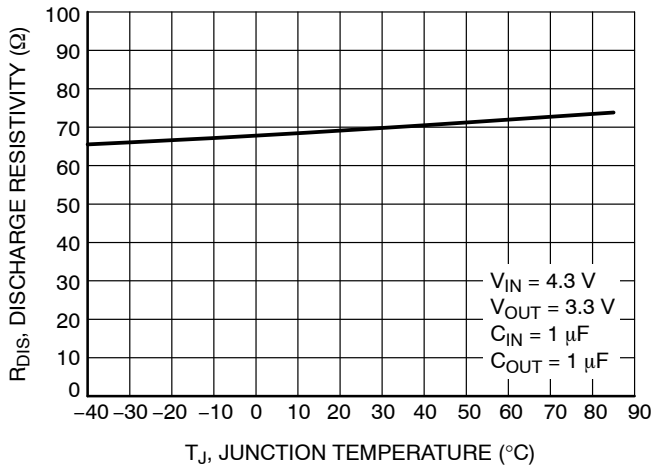

Figure 19. Discharge Resistance vs. Temperature

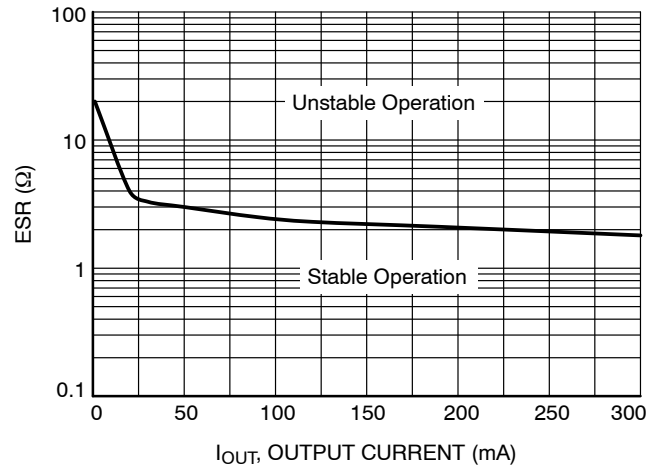
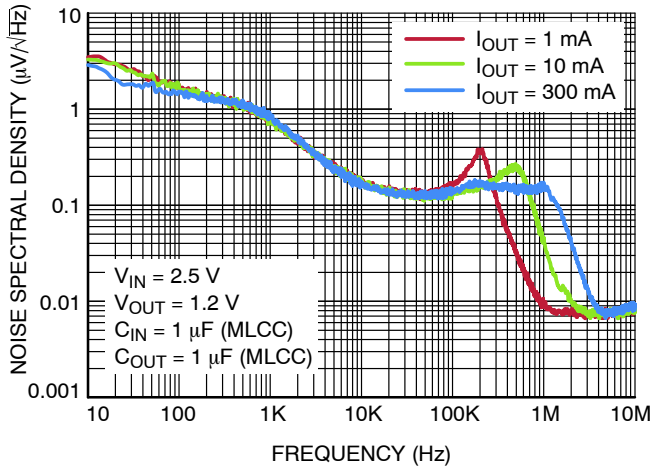

Figure 20. Maximum C<sub>OUT</sub> ESR Value vs. Load Current

TYPICAL CHARACTERISTICS



| $I_{OUT}$ | RMS Output Noise ( $\mu\text{V}_{RMS}$ ) |                  |
|-----------|--|------------------|
|           | 10 Hz – 100 kHz                          | 100 Hz – 100 kHz |
| 1 mA      | 65.6                                     | 61.9             |
| 10 mA     | 63.1                                     | 59.5             |
| 300 mA    | 62.3                                     | 60.3             |

Figure 21. Output Voltage Noise Spectral Density –  $V_{OUT} = 1.2\text{ V}$



| $I_{OUT}$ | RMS Output Noise ( $\mu\text{V}_{RMS}$ ) |                  |
|-----------|--|------------------|
|           | 10 Hz – 100 kHz                          | 100 Hz – 100 kHz |
| 1 mA      | 93.4                                     | 87.9             |
| 10 mA     | 92.1                                     | 86.6             |
| 300 mA    | 119.3                                    | 115.6            |

Figure 22. Output Voltage Noise Spectral Density –  $V_{OUT} = 2.8\text{ V}$

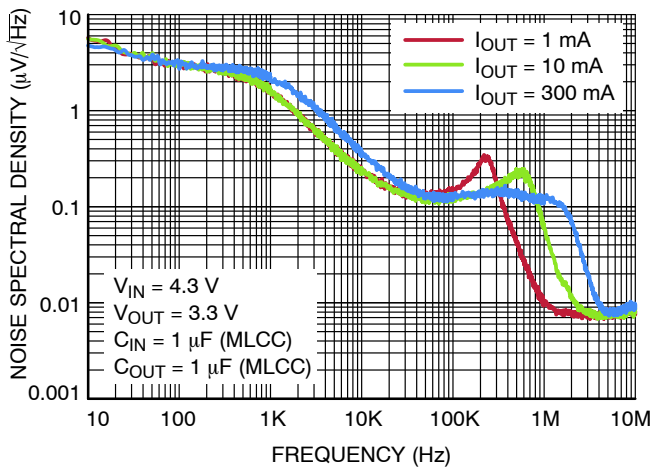

| $I_{OUT}$ | RMS Output Noise ( $\mu\text{V}_{RMS}$ ) |                  |
|-----------|--|------------------|
|           | 10 Hz – 100 kHz                          | 100 Hz – 100 kHz |
| 1 mA      | 104.0                                    | 98.0             |
| 10 mA     | 102.9                                    | 96.7             |
| 300 mA    | 131.4                                    | 127.0            |

Figure 23. Output Voltage Noise Spectral Density –  $V_{OUT} = 3.3\text{ V}$

TYPICAL CHARACTERISTICS

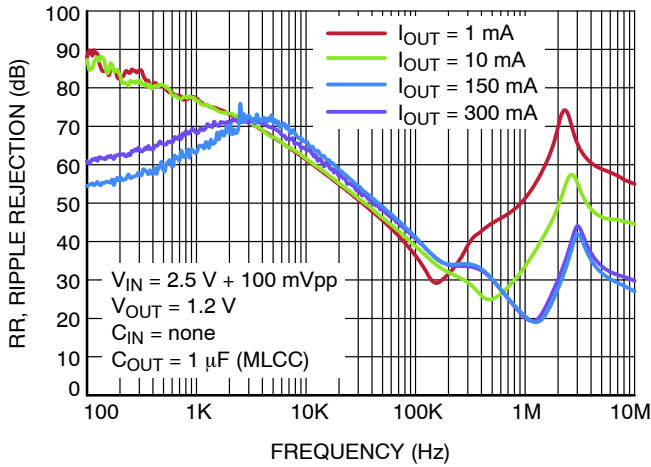

Figure 24. Power Supply Rejection Ratio,  $V_{OUT} = 1.2\text{ V}$



Figure 25. Power Supply Rejection Ratio,  $V_{OUT} = 1.8\text{ V}$

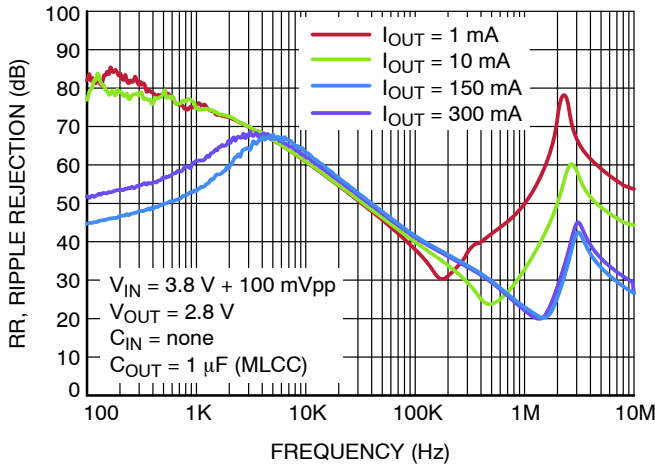

Figure 26. Power Supply Rejection Ratio,  $V_{OUT} = 2.8\text{ V}$

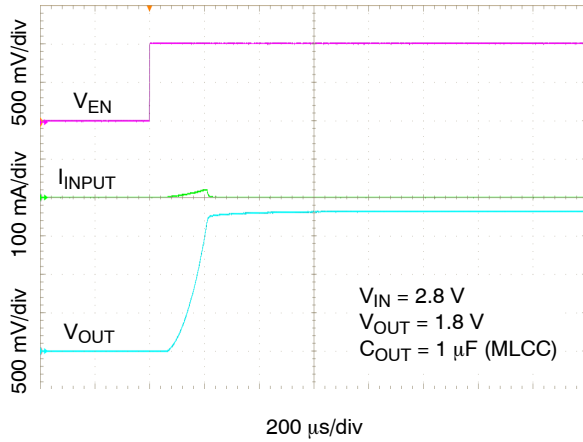

Figure 27. Power Supply Rejection Ratio,  $V_{OUT} = 3.3\text{ V}$



# NCP115

## TYPICAL CHARACTERISTICS



**Figure 28. Enable Turn-on Response –  
I<sub>OUT</sub> = 0 mA, Slow Option – C**



**Figure 29. Enable Turn-on Response –  
I<sub>OUT</sub> = 300 mA, Slow Option – C**

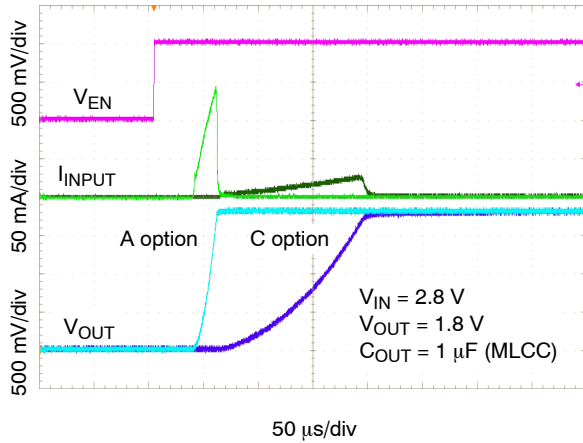

**Figure 30. V<sub>OUT</sub> Slew-Rate Comparison A and  
C option – I<sub>OUT</sub> = 10 mA**

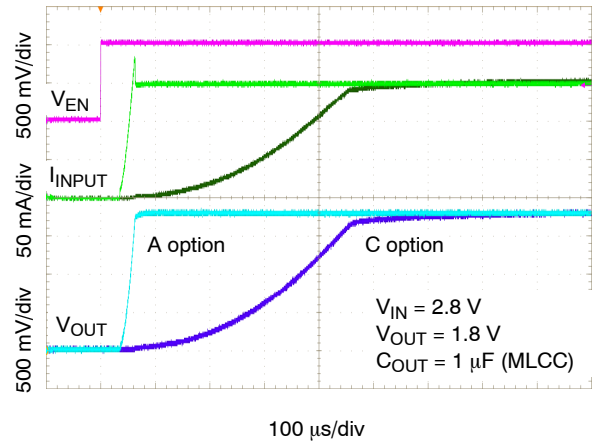

**Figure 31. V<sub>OUT</sub> Slew-Rate Comparison A and  
C option – I<sub>OUT</sub> = 300 mA**

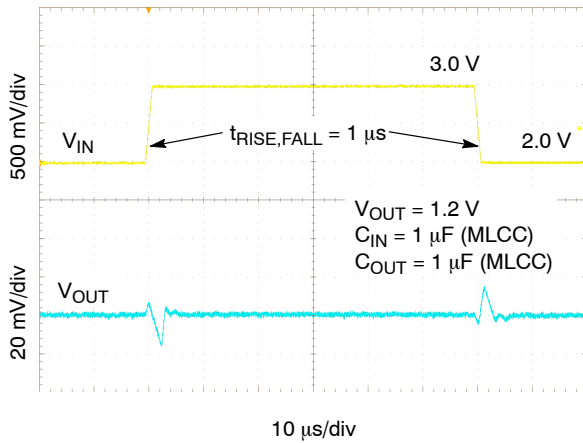

**Figure 32. Line Transient Response –  
I<sub>OUT</sub> = 10 mA**

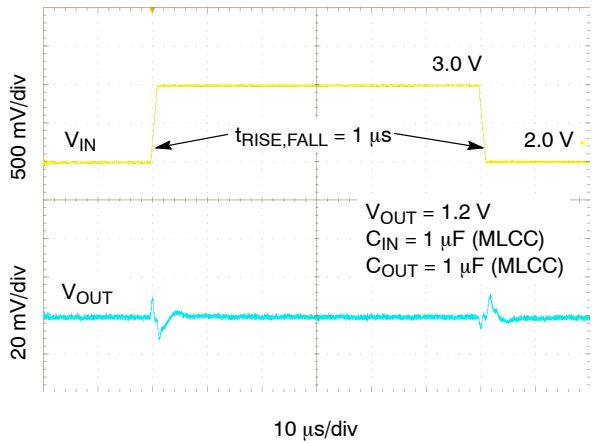

**Figure 33. Line Transient Response –  
I<sub>OUT</sub> = 300 mA**

TYPICAL CHARACTERISTICS

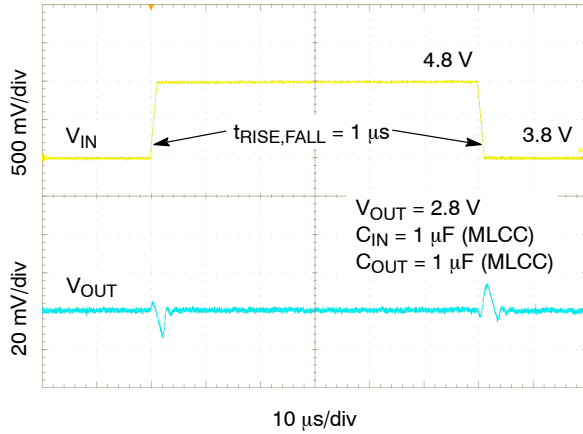

Figure 34. Line Transient Response -  $I_{OUT} = 10 \text{ mA}$

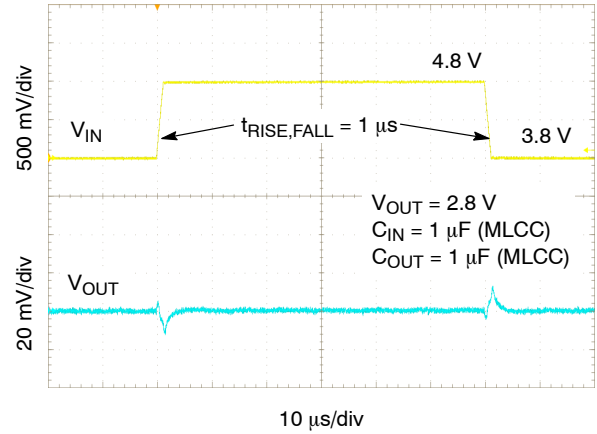

Figure 35. Line Transient Response -  $I_{OUT} = 300 \text{ mA}$

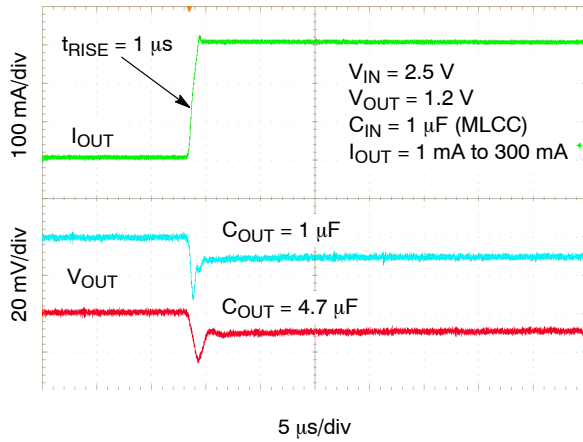

Figure 36. Load Transient Response -  $V_{OUT} = 1.2 \text{ V}$

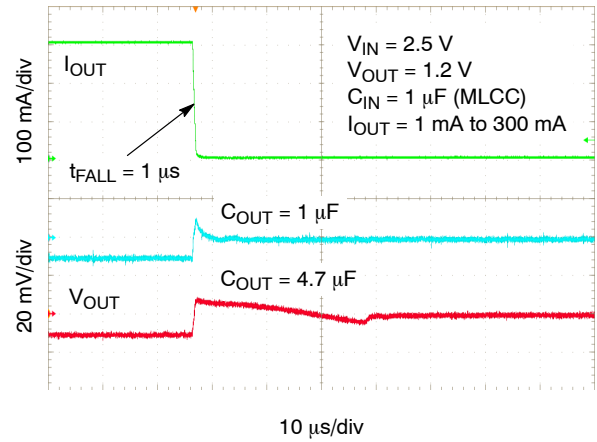

Figure 37. Load Transient Response -  $V_{OUT} = 1.2 \text{ V}$

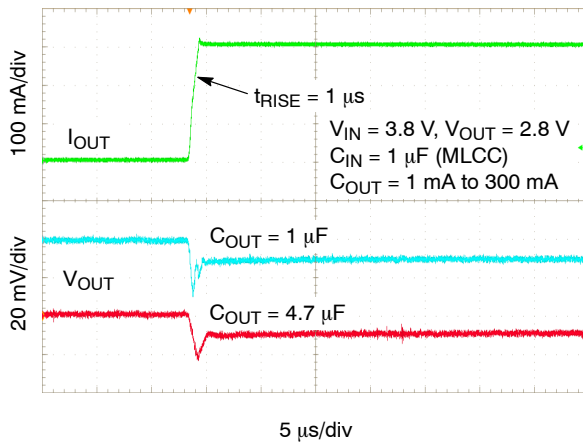

Figure 38. Load Transient Response -  $V_{OUT} = 2.8 \text{ V}$

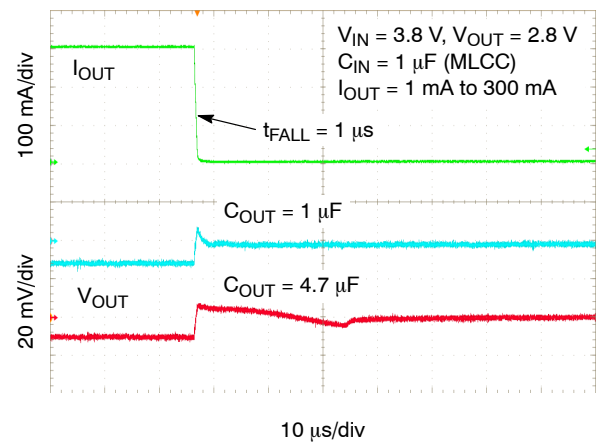

Figure 39. Load Transient Response -  $V_{OUT} = 2.8 \text{ V}$

TYPICAL CHARACTERISTICS



Figure 40. Load Transient Response -  $V_{OUT} = 3.3\text{ V}$

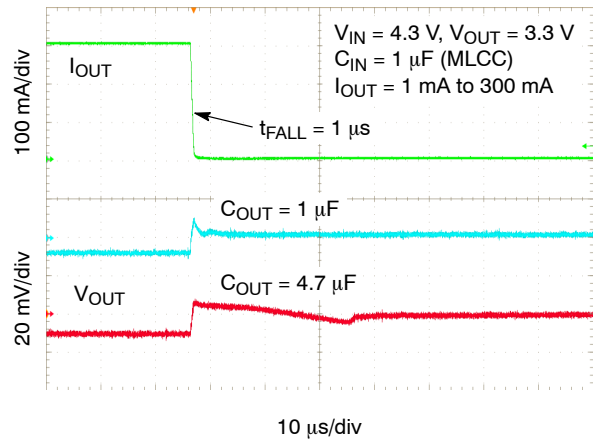

Figure 41. Load Transient Response -  $V_{OUT} = 3.3\text{ V}$

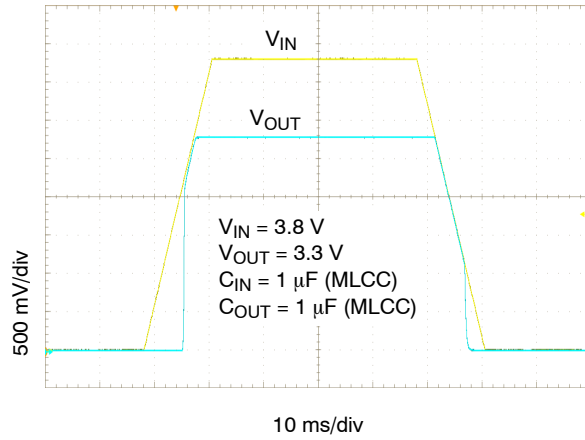

Figure 42. Turn-on/off - Slow Rising  $V_{IN} - I_{OUT} = 10\text{ mA}$

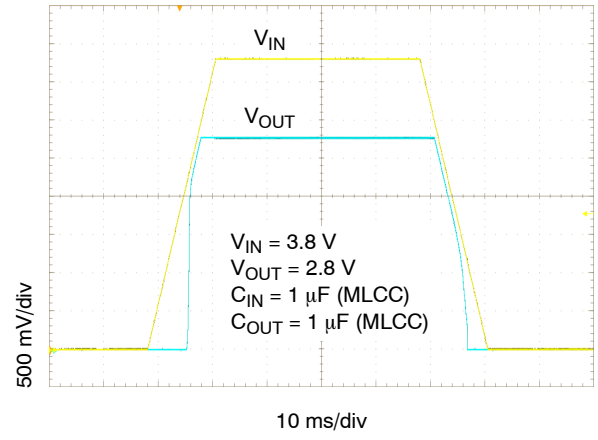

Figure 43. Turn-on/off - Slow Rising  $V_{IN} - I_{OUT} = 300\text{ mA}$

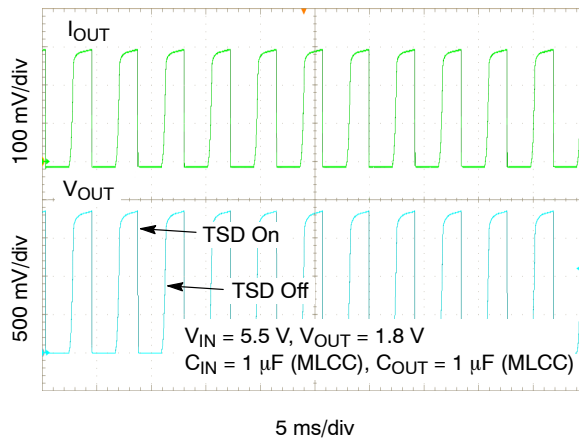

Figure 44. Overheating Protection - TSD

APPLICATIONS INFORMATION

**General**

The NCP115 is a high performance 300 mA Low Dropout Linear Regulator. This device delivers very high PSRR (over 70 dB at 1 kHz) and excellent dynamic performance as load/line transients. In connection with very low quiescent current this device is very suitable for various battery powered applications such as tablets, cellular phones, wireless and many others. The device is fully protected in case of output overload, output short circuit condition and overheating, assuring a very robust design.

**Input Capacitor Selection (C<sub>IN</sub>)**

It is recommended to connect at least a 1 μF Ceramic X5R or X7R capacitor as close as possible to the IN pin of the device. This capacitor will provide a low impedance path for unwanted AC signals or noise modulated onto constant input voltage. There is no requirement for the min. /max. ESR of the input capacitor but it is recommended to use ceramic capacitors for their low ESR and ESL. A good input capacitor will limit the influence of input trace inductance and source resistance during sudden load current changes. Larger input capacitor may be necessary if fast and large load transients are encountered in the application.

**Output Decoupling (C<sub>OUT</sub>)**

The NCP115 requires an output capacitor connected as close as possible to the output pin of the regulator. The recommended capacitor value is 1 μF and X7R or X5R dielectric due to its low capacitance variations over the specified temperature range. The NCP115 is designed to remain stable with minimum effective capacitance of 0.47 μF to account for changes with temperature, DC bias and package size. Especially for small package size capacitors such as 0402 the effective capacitance drops rapidly with the applied DC bias.

There is no requirement for the minimum value of Equivalent Series Resistance (ESR) for the C<sub>OUT</sub> but the maximum value of ESR should be less than 1.8 Ω. Larger output capacitors and lower ESR could improve the load transient response or high frequency PSRR. It is not recommended to use tantalum capacitors on the output due to their large ESR. The equivalent series resistance of tantalum capacitors is also strongly dependent on the temperature, increasing at low temperature.

**Enable Operation**

The NCP115 uses the EN pin to enable/disable its device and to deactivate/activate the active discharge function.

If the EN pin voltage is <0.4 V the device is guaranteed to be disabled. The pass transistor is turned-off so that there is virtually no current flow between the IN and OUT. The active discharge transistor is active so that the output voltage V<sub>OUT</sub> is pulled to GND through a 100 Ω resistor. In the

disable state the device consumes as low as typ. 10 nA from the V<sub>IN</sub>.

If the EN pin voltage >0.9 V the device is guaranteed to be enabled. The NCP115 regulates the output voltage and the active discharge transistor is turned-off.

The EN pin has internal pull-down current source with typ. value of 300 nA which assures that the device is turned-off when the EN pin is not connected. In the case where the EN function isn't required the EN should be tied directly to IN.

**Output Current Limit**

Output Current is internally limited within the IC to a typical 600 mA. The NCP115 will source this amount of current measured with a voltage drops on the 90% of the nominal V<sub>OUT</sub>. If the Output Voltage is directly shorted to ground (V<sub>OUT</sub> = 0 V), the short circuit protection will limit the output current to 630 mA (typ). The current limit and short circuit protection will work properly over whole temperature range and also input voltage range. There is no limitation for the short circuit duration.

**Thermal Shutdown**

When the die temperature exceeds the Thermal Shutdown threshold (T<sub>SD</sub> – 160°C typical), Thermal Shutdown event is detected and the device is disabled. The IC will remain in this state until the die temperature decreases below the Thermal Shutdown Reset threshold (T<sub>SDU</sub> – 140°C typical). Once the IC temperature falls below the 140°C the LDO is enabled again. The thermal shutdown feature provides the protection from a catastrophic device failure due to accidental overheating. This protection is not intended to be used as a substitute for proper heat sinking.

**Power Dissipation**

As power dissipated in the NCP115 increases, it might become necessary to provide some thermal relief. The maximum power dissipation supported by the device is dependent upon board design and layout. Mounting pad configuration on the PCB, the board material, and the ambient temperature affect the rate of junction temperature rise for the part.

The maximum power dissipation the NCP115 can handle is given by:

$$P_{D(MAX)} = \frac{[85^{\circ}C - T_A]}{\theta_{JA}} \quad (\text{eq. 1})$$

The power dissipated by the NCP115 for given application conditions can be calculated from the following equations:

$$P_D \approx V_{IN}(I_{GND@I_{OUT}}) + I_{OUT}(V_{IN} - V_{OUT}) \quad (\text{eq. 2})$$

# NCP115

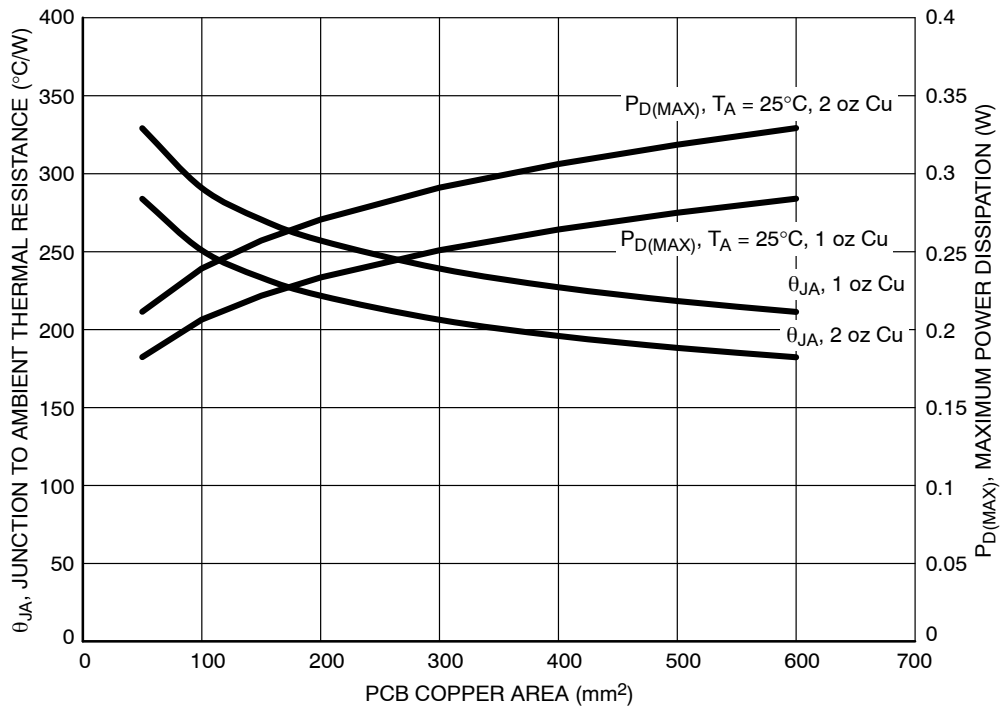

Figure 45.  $\theta_{JA}$  and  $P_{D(MAX)}$  vs. Copper Area (XDFN4)

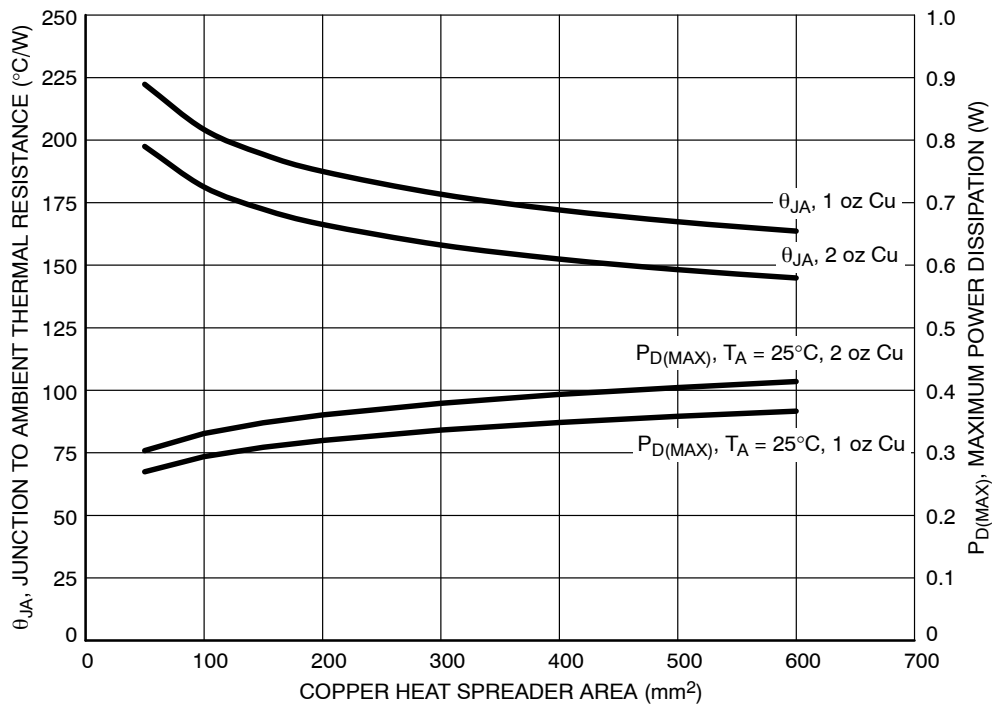

Figure 46.  $\theta_{JA}$  and  $P_{D(MAX)}$  vs. Copper Area (TSOP-5)

## NCP115

### Reverse Current

The PMOS pass transistor has an inherent body diode which will be forward biased in the case that  $V_{OUT} > V_{IN}$ . Due to this fact in cases, where the extended reverse current condition can be anticipated the device may require additional external protection.

### Power Supply Rejection Ratio

The NCP115 features very good Power Supply Rejection ratio. If desired the PSRR at higher frequencies in the range 100 kHz – 10 MHz can be tuned by the selection of  $C_{OUT}$  capacitor and proper PCB layout.

### Turn-On Time

The turn-on time is defined as the time period from EN assertion to the point in which  $V_{OUT}$  will reach 98% of its nominal value. This time is dependent on various application conditions such as  $V_{OUT(NOM)}$ ,  $C_{OUT}$  and  $T_A$ .

The NCP115 provides two options of  $V_{OUT}$  ramp-up time. The NCP115A and NCP115B have normal slew rate, typical 190 mV/ $\mu$ s and NCP115C and NCP115D provide slower option with typical value 20 mV/ $\mu$ s which is suitable for camera sensor and other sensitive devices.

### PCB Layout Recommendations

To obtain good transient performance and good regulation characteristics place  $C_{IN}$  and  $C_{OUT}$  capacitors close to the device pins and make the PCB traces wide. In order to minimize the solution size, use 0402 capacitors. Larger copper area connected to the pins will also improve the device thermal resistance. The actual power dissipation can be calculated from the equation above (Equation 2). Expose pad should be tied the shortest path to the GND pin.

# NCP115

## ORDERING INFORMATION – XDFN4 PACKAGE

| Device          | Voltage Option | Marking | Description                                   | Package            | Shipping              |
|-----------------|----------------|---------|---|--------------------|-----------------------|
| NCP115AMX100TCG | 1.0 V          | QN      | 300 mA, Active Discharge,<br>Normal Slew-rate | XDFN4<br>(Pb-Free) | 3000 / Tape &<br>Reel |
| NCP115AMX105TCG | 1.05 V         | QM      |   |                    |                       |
| NCP115AMX110TBG | 1.1 V          | QL      |   |                    |                       |
| NCP115AMX110TCG |                |         |   |                    |                       |
| NCP115AMX120TBG | 1.2 V          | QA      |   |                    |                       |
| NCP115AMX120TCG |                |         |   |                    |                       |
| NCP115AMX150TCG | 1.5 V          | QE      |   |                    |                       |
| NCP115AMX180TBG | 1.8 V          | QC      |   |                    |                       |
| NCP115AMX180TCG |                |         |   |                    |                       |
| NCP115AMX250TCG | 2.5 V          | QF      |   |                    |                       |
| NCP115AMX280TBG | 2.8 V          | QG      |   |                    |                       |
| NCP115AMX280TCG |                |         |   |                    |                       |
| NCP115AMX300TCG | 3.0 V          | QK      |   |                    |                       |
| NCP115AMX330TBG | 3.3 V          | QH      |   |                    |                       |
| NCP115AMX330TCG |                |         |   |                    |                       |
| NCP115AMX360TCG | 3.6 V          | QJ      |   |                    |                       |
| NCP115CMX100TCG | 1.0 V          | RN      | 300 mA, Active Discharge,<br>Slow Slew-rate   |                    |                       |
| NCP115CMX105TCG | 1.05 V         | RM      |   |                    |                       |
| NCP115CMX110TBG | 1.1 V          | RF      |   |                    |                       |
| NCP115CMX110TCG |                |         |   |                    |                       |
| NCP115CMX120TBG | 1.2 V          | RE      |   |                    |                       |
| NCP115CMX120TCG |                |         |   |                    |                       |
| NCP115CMX150TCG | 1.5 V          | RG      |   |                    |                       |
| NCP115CMX180TBG | 1.8 V          | RA      |   |                    |                       |
| NCP115CMX180TCG |                |         |   |                    |                       |
| NCP115CMX250TCG | 2.5 V          | RH      |   |                    |                       |
| NCP115CMX280TBG | 2.8 V          | RC      |   |                    |                       |
| NCP115CMX280TCG |                |         |   |                    |                       |
| NCP115CMX300TCG | 3.0 V          | RK      |   |                    |                       |
| NCP115CMX330TBG | 3.3 V          | RD      |   |                    |                       |
| NCP115CMX330TCG |                |         |   |                    |                       |
| NCP115CMX360TCG | 3.6 V          | RJ      |   |                    |                       |

# NCP115

## ORDERING INFORMATION – TSOP–5 PACKAGE

| Device          | Voltage Option | Marking | Description                                | Package             | Shipping              |
|-----------------|----------------|---------|--|---------------------|-----------------------|
| NCP115ASN105T1G | 1.05 V         | QAC     | 300 mA, Active Discharge, Normal Slew–rate | TSOP–5<br>(Pb–Free) | 3000 / Tape &<br>Reel |
| NCP115ASN110T1G | 1.1 V          | QAD     |  |                     |                       |
| NCP115ASN120T1G | 1.2 V          | QAE     |  |                     |                       |
| NCP115ASN120T2G | 1.2 V          | QAE     |  |                     |                       |
| NCP115ASN150T1G | 1.5 V          | QAF     |  |                     |                       |
| NCP115ASN150T2G | 1.5 V          | QAF     |  |                     |                       |
| NCP115ASN180T1G | 1.8 V          | QAA     |  |                     |                       |
| NCP115ASN180T2G | 1.8 V          | QAA     |  |                     |                       |
| NCP115ASN250T1G | 2.5 V          | QAG     |  |                     |                       |
| NCP115ASN250T2G | 2.5 V          | QAG     |  |                     |                       |
| NCP115ASN280T1G | 2.8 V          | QAH     |  |                     |                       |
| NCP115ASN280T2G | 2.8 V          | QAH     |  |                     |                       |
| NCP115ASN300T1G | 3.0 V          | QAJ     |  |                     |                       |
| NCP115ASN330T1G | 3.3 V          | QAK     |  |                     |                       |
| NCP115ASN330T2G | 3.3 V          | QAK     |  |                     |                       |
| NCP115CSN105T1G | 1.05 V         | QCC     | 300 mA, Active Discharge, Slow Slew–rate   | TSOP–5<br>(Pb–Free) | 3000 / Tape &<br>Reel |
| NCP115CSN110T1G | 1.1 V          | QCD     |  |                     |                       |
| NCP115CSN120T1G | 1.2 V          | QCE     |  |                     |                       |
| NCP115CSN150T1G | 1.5 V          | QCF     |  |                     |                       |
| NCP115CSN180T1G | 1.8 V          | QCA     |  |                     |                       |
| NCP115CSN250T1G | 2.5 V          | QCG     |  |                     |                       |
| NCP115CSN280T1G | 2.8 V          | QCH     |  |                     |                       |
| NCP115CSN300T1G | 3.0 V          | QCJ     |  |                     |                       |
| NCP115CSN330T1G | 3.3 V          | QCK     |  |                     |                       |

Bluetooth is a registered trademark of Bluetooth SIG.  
ZigBee is a registered trademark of ZigBee Alliance.



# MECHANICAL CASE OUTLINE PACKAGE DIMENSIONS

ON Semiconductor®



SCALE 2:1

## TSOP-5 CASE 483 ISSUE N

DATE 12 AUG 2020



NOTES:

1. DIMENSIONING AND TOLERANCING PER ASME Y14.5M, 1994.
2. CONTROLLING DIMENSION: MILLIMETERS.
3. MAXIMUM LEAD THICKNESS INCLUDES LEAD FINISH THICKNESS. MINIMUM LEAD THICKNESS IS THE MINIMUM THICKNESS OF BASE MATERIAL.
4. DIMENSIONS A AND B DO NOT INCLUDE MOLD FLASH, PROTRUSIONS, OR GATE BURRS. MOLD FLASH, PROTRUSIONS, OR GATE BURRS SHALL NOT EXCEED 0.15 PER SIDE. DIMENSION A.
5. OPTIONAL CONSTRUCTION: AN ADDITIONAL TRIMMED LEAD IS ALLOWED IN THIS LOCATION. TRIMMED LEAD NOT TO EXTEND MORE THAN 0.2 FROM BODY.

| DIM | MILLIMETERS |      |
|-----|-------------|------|
|     | MIN         | MAX  |
| A   | 2.85        | 3.15 |
| B   | 1.35        | 1.65 |
| C   | 0.90        | 1.10 |
| D   | 0.25        | 0.50 |
| G   | 0.95 BSC    |      |
| H   | 0.01        | 0.10 |
| J   | 0.10        | 0.26 |
| K   | 0.20        | 0.60 |
| M   | 0°          | 10°  |
| S   | 2.50        | 3.00 |

### SOLDERING FOOTPRINT\*



\*For additional information on our Pb-Free strategy and soldering details, please download the ON Semiconductor Soldering and Mounting Techniques Reference Manual, SOLDERRM/D.

### GENERIC MARKING DIAGRAM\*



- |                            |                            |
|----------------------------|----------------------------|
| XXX = Specific Device Code | XXX = Specific Device Code |
| A = Assembly Location      | M = Date Code              |
| Y = Year                   | ▪ = Pb-Free Package        |
| W = Work Week              |                            |
| ▪ = Pb-Free Package        |                            |

(Note: Microdot may be in either location)

\*This information is generic. Please refer to device data sheet for actual part marking. Pb-Free indicator, "G" or microdot "▪", may or may not be present.

|                         |                    |  |
|-------------------------|--------------------|--|
| <b>DOCUMENT NUMBER:</b> | <b>98ARB18753C</b> | Electronic versions are uncontrolled except when accessed directly from the Document Repository. Printed versions are uncontrolled except when stamped "CONTROLLED COPY" in red. |
| <b>DESCRIPTION:</b>     | <b>TSOP-5</b>      | <b>PAGE 1 OF 1</b>   |

ON Semiconductor and ON are trademarks of Semiconductor Components Industries, LLC dba ON Semiconductor or its subsidiaries in the United States and/or other countries. ON Semiconductor reserves the right to make changes without further notice to any products herein. ON Semiconductor makes no warranty, representation or guarantee regarding the suitability of its products for any particular purpose, nor does ON Semiconductor assume any liability arising out of the application or use of any product or circuit, and specifically disclaims any and all liability, including without limitation special, consequential or incidental damages. ON Semiconductor does not convey any license under its patent rights nor the rights of others.

# MECHANICAL CASE OUTLINE PACKAGE DIMENSIONS

ON Semiconductor®



SCALE 4:1

XDFN4 1.0x1.0, 0.65P  
CASE 711AJ  
ISSUE B

DATE 25 JUN 2021

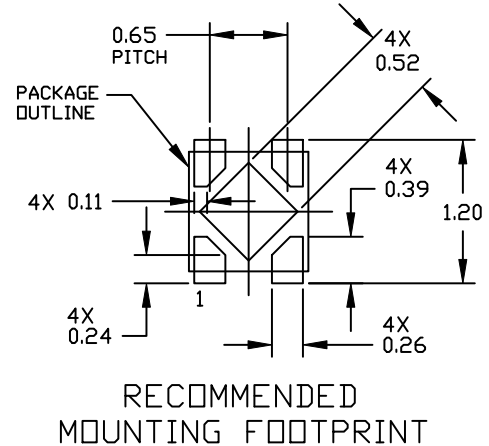
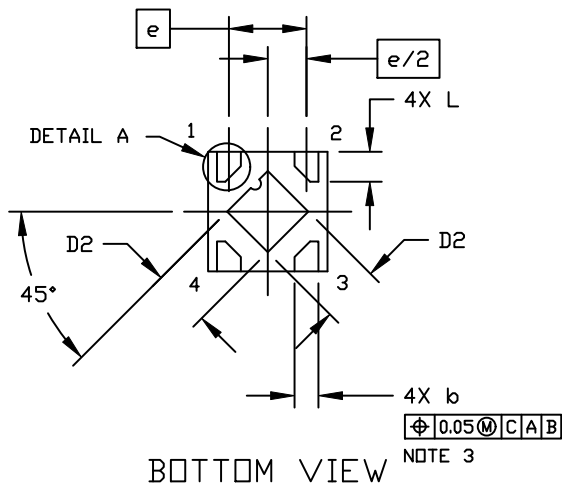
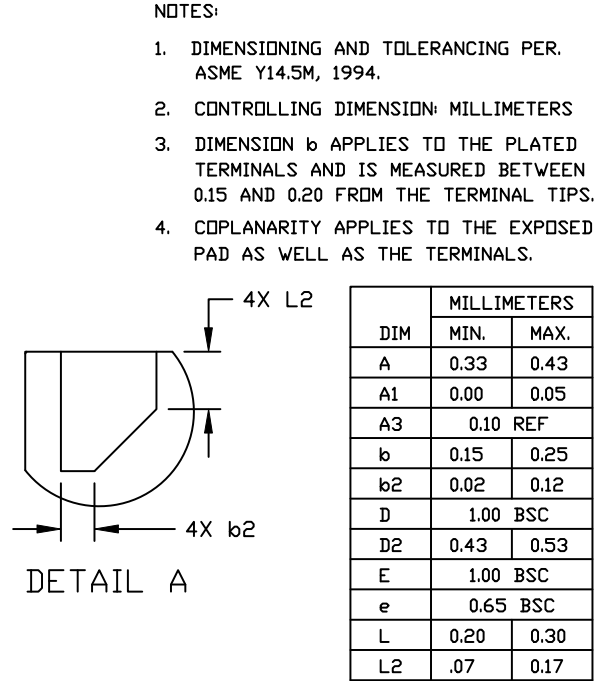
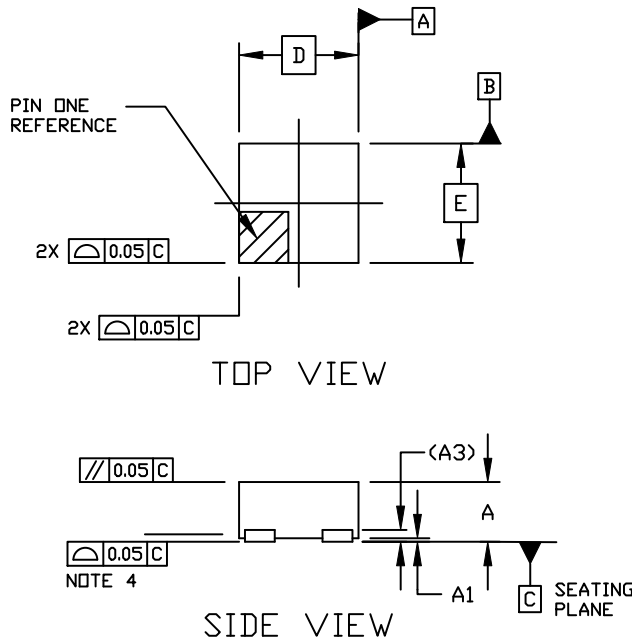

### GENERIC MARKING DIAGRAM\*

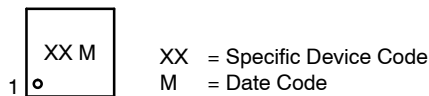

\*This information is generic. Please refer to device data sheet for actual part marking. Pb-Free indicator, "G" or microdot "μ", may or may not be present. Some products may not follow the Generic Marking.

|                         |                              |  |
|-------------------------|------------------------------|--|
| <b>DOCUMENT NUMBER:</b> | <b>98AON67179E</b>           | Electronic versions are uncontrolled except when accessed directly from the Document Repository. Printed versions are uncontrolled except when stamped "CONTROLLED COPY" in red. |
| <b>DESCRIPTION:</b>     | <b>XDFN4, 1.0X1.0, 0.65P</b> | <b>PAGE 1 OF 1</b>   |

ON Semiconductor and ON are trademarks of Semiconductor Components Industries, LLC dba ON Semiconductor or its subsidiaries in the United States and/or other countries. ON Semiconductor reserves the right to make changes without further notice to any products herein. ON Semiconductor makes no warranty, representation or guarantee regarding the suitability of its products for any particular purpose, nor does ON Semiconductor assume any liability arising out of the application or use of any product or circuit, and specifically disclaims any and all liability, including without limitation special, consequential or incidental damages. ON Semiconductor does not convey any license under its patent rights nor the rights of others.

**onsemi**, **Onsemi**, and other names, marks, and brands are registered and/or common law trademarks of Semiconductor Components Industries, LLC dba "**onsemi**" or its affiliates and/or subsidiaries in the United States and/or other countries. **onsemi** owns the rights to a number of patents, trademarks, copyrights, trade secrets, and other intellectual property. A listing of **onsemi**'s product/patent coverage may be accessed at [www.onsemi.com/site/pdf/Patent-Marking.pdf](http://www.onsemi.com/site/pdf/Patent-Marking.pdf). **onsemi** reserves the right to make changes at any time to any products or information herein, without notice. The information herein is provided "as-is" and **onsemi** makes no warranty, representation or guarantee regarding the accuracy of the information, product features, availability, functionality, or suitability of its products for any particular purpose, nor does **onsemi** assume any liability arising out of the application or use of any product or circuit, and specifically disclaims any and all liability, including without limitation special, consequential or incidental damages. Buyer is responsible for its products and applications using **onsemi** products, including compliance with all laws, regulations and safety requirements or standards, regardless of any support or applications information provided by **onsemi**. "Typical" parameters which may be provided in **onsemi** data sheets and/or specifications can and do vary in different applications and actual performance may vary over time. All operating parameters, including "Typicals" must be validated for each customer application by customer's technical experts. **onsemi** does not convey any license under any of its intellectual property rights nor the rights of others. **onsemi** products are not designed, intended, or authorized for use as a critical component in life support systems or any FDA Class 3 medical devices or medical devices with a same or similar classification in a foreign jurisdiction or any devices intended for implantation in the human body. Should Buyer purchase or use **onsemi** products for any such unintended or unauthorized application, Buyer shall indemnify and hold **onsemi** and its officers, employees, subsidiaries, affiliates, and distributors harmless against all claims, costs, damages, and expenses, and reasonable attorney fees arising out of, directly or indirectly, any claim of personal injury or death associated with such unintended or unauthorized use, even if such claim alleges that **onsemi** was negligent regarding the design or manufacture of the part. **onsemi** is an Equal Opportunity/Affirmative Action Employer. This literature is subject to all applicable copyright laws and is not for resale in any manner.

## PUBLICATION ORDERING INFORMATION

### LITERATURE FULFILLMENT:

Email Requests to: [orderlit@onsemi.com](mailto:orderlit@onsemi.com)

**onsemi Website:** [www.onsemi.com](http://www.onsemi.com)

### TECHNICAL SUPPORT

**North American Technical Support:**  
Voice Mail: 1 800-282-9855 Toll Free USA/Canada  
Phone: 011 421 33 790 2910

**Europe, Middle East and Africa Technical Support:**

Phone: 00421 33 790 2910

For additional information, please contact your local Sales Representative

# Mouser Electronics

Authorized Distributor

Click to View Pricing, Inventory, Delivery & Lifecycle Information:

[onsemi:](#)

[STR-NCP115-EVK](#)