

■ Features

- $V_{DS} (V) = 30V$
- $I_D = 5.8 A (V_{GS} = 10V)$
- $R_{DS(ON)} < 27m\Omega (V_{GS} = 10V)$
- $R_{DS(ON)} < 31m\Omega (V_{GS} = 4.5V)$
- $R_{DS(ON)} < 48m\Omega (V_{GS} = 2.5V)$

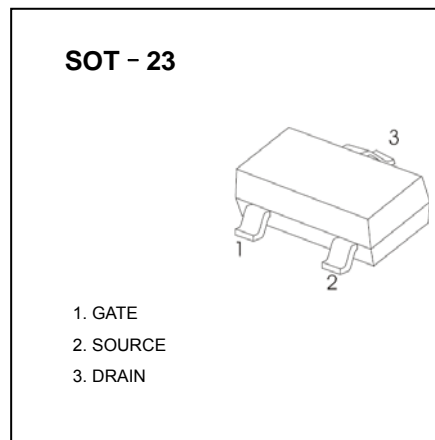
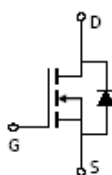

■ Absolute Maximum Ratings $T_a = 25^\circ C$

Parameter	Symbol	Rating	Unit
Drain-Source Voltage	V_{DS}	30	V
Gate-Source Voltage	V_{GS}	± 12	V
Continuous Drain Current	I_D	$T_A=25^\circ C$	A
		$T_A=70^\circ C$	
Pulsed Drain Current *	I_{DM}	30	
Power Dissipation	P_D	$T_A=25^\circ C$	W
		$T_A=70^\circ C$	
Thermal Resistance.Junction- to-Ambient	R_{thJA}	125	$^\circ C/W$
Thermal Resistance.Junction- to-Case	R_{thc}	60	$^\circ C/W$
Junction and Storage Temperature Range	T_J, T_{STG}	-55 to 150	$^\circ C$

* Repetitive rating, pulse width limited by junction temperature.

■ Electrical Characteristics Ta = 25°C

Parameter	Symbol	Testconditions	Min	Typ	Max	Unit
Drain-Source Breakdown Voltage	V _{bss}	I _D =250 μA, V _{GS} =0V	30			V
Zero Gate Voltage Drain Current	I _{DSS}	V _{DS} =24V, V _{GS} =0V			1	μA
		V _{DS} =24V, V _{GS} =0V, T _J =55°C			5	
Gate-Body leakage current	I _{GSS}	V _{DS} =0V, V _{GS} =±12V			±100	nA
Gate Threshold Voltage	V _{GS(th)}	V _{DS} =V _{GS} I _D =250 μA	0.7	1.1	1.4	V
Static Drain-Source On-Resistance	R _{DS(on)}	V _{GS} =10V, I _D =5.8A			27	mΩ
		V _{GS} =4.5V, I _D =5A			31	
		V _{GS} =2.5V, I _D =4A			48	mΩ
On state drain current	I _{D(ON)}	V _{GS} =4.5V, V _{DS} =5V	30			A
Forward Transconductance	g _{FS}	V _{DS} =5V, I _D =5A	10	15		S
Input Capacitance	C _{iss}	V _{GS} =0V, V _{DS} =15V, f=1MHz		823	1050	pF
Output Capacitance	C _{oss}			99		pF
Reverse Transfer Capacitance	C _{rss}			77		pF
Gate resistance	R _g	V _{GS} =0V, V _{DS} =0V, f=1MHz		1.4	3.6	Ω
Total Gate Charge	Q _g	V _{GS} =4.5V, V _{DS} =15V, I _D =5.8A		9.7	12	nC
Gate Source Charge	Q _{gs}			1.6		nC
Gate Drain Charge	Q _{gd}			3.1		nC
Turn-On DelayTime	t _{D(on)}	V _{GS} =10V, V _{DS} =15V, R _L =2.7 Ω, R _{GEN} =3 Ω		3.3	5	ns
Turn-On Rise Time	t _r			4.8	7	ns
Turn-Off DelayTime	t _{D(off)}			26.3	40	ns
Turn-Off Fall Time	t _f			4.1	6	ns
Body Diode Reverse Recovery Time	t _{rr}		I _F =5A, di/dt=100A/μs		16	20
Body Diode Reverse Recovery Charge	Q _{rr}	I _F =5A, di/dt=100A/μs		8.9	12	nC
Maximum Body-Diode Continuous Current	I _S				2.5	A
Diode Forward Voltage	V _{SD}	I _S =1A, V _{GS} =0V		0.71	1	V

■ Typical Characteristics

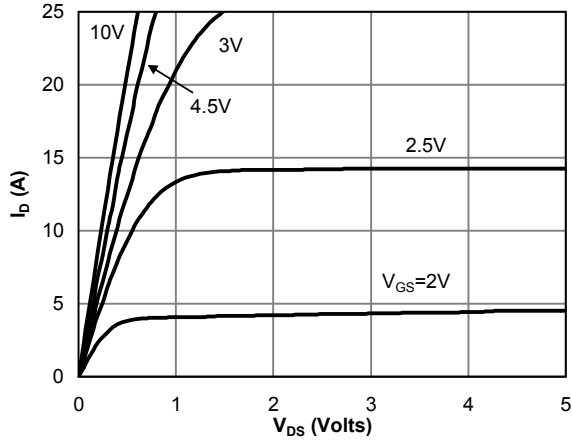

Fig 1: On-Region Characteristics

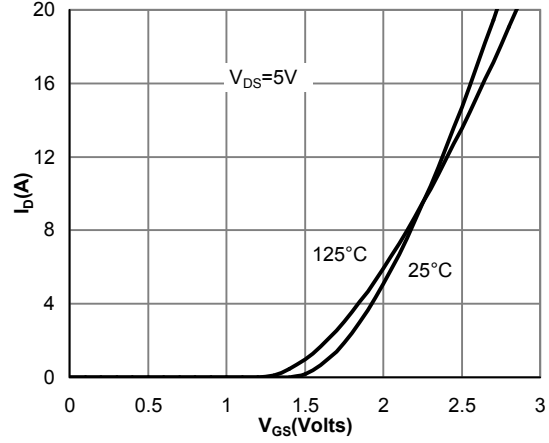

Figure 2: Transfer Characteristics

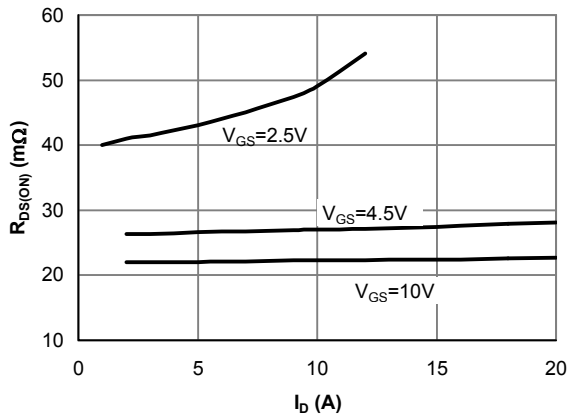

Figure 3: On-Resistance vs. Drain Current and Gate Voltage

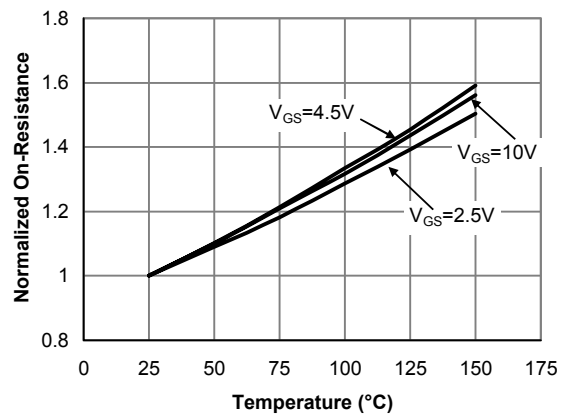

Figure 4: On-Resistance vs. Junction Temperature

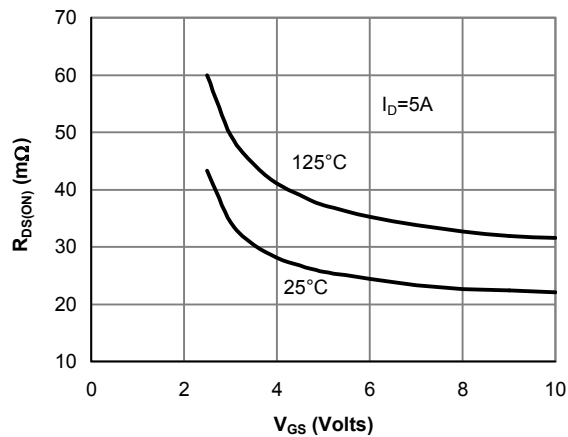

Figure 5: On-Resistance vs. Gate-Source Voltage

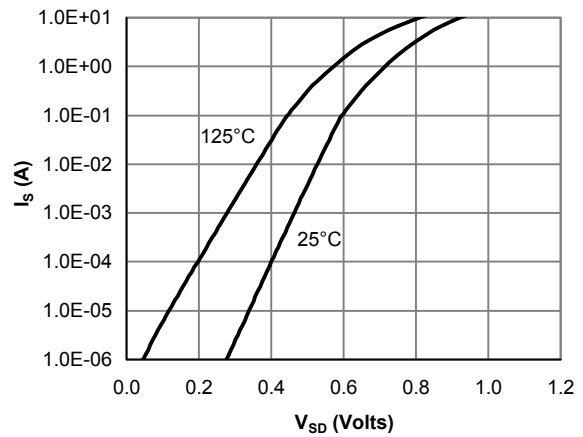

Figure 6: Body-Diode Characteristics

■ Typical Characteristics

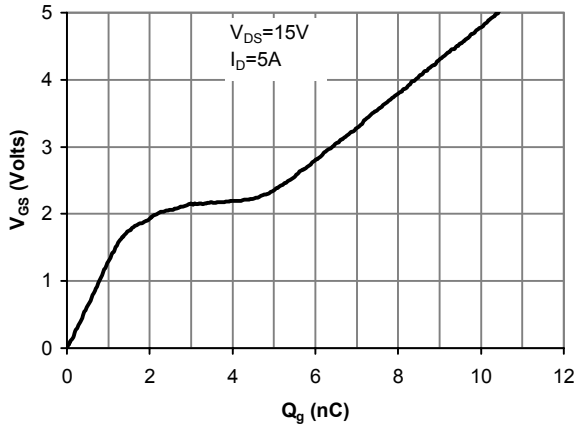

Figure 7: Gate-Charge Characteristics

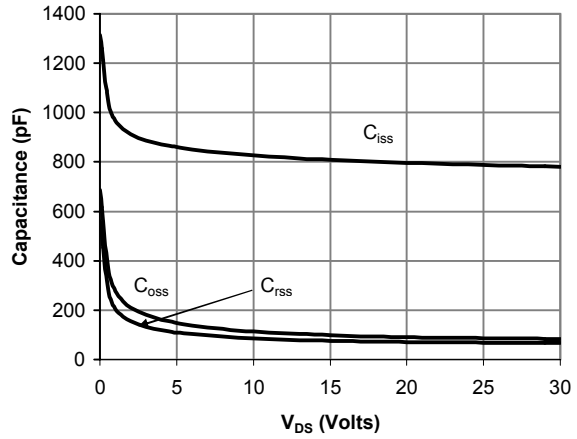

Figure 8: Capacitance Characteristics

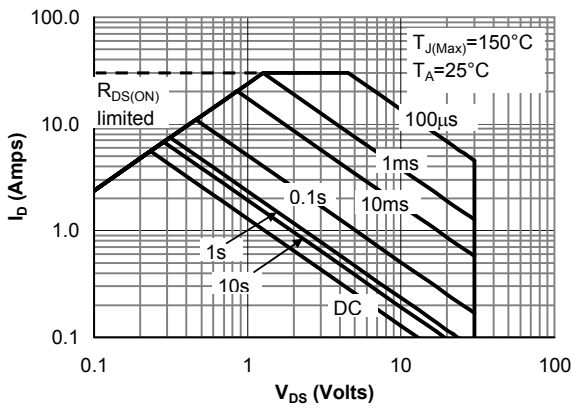

Figure 9: Maximum Forward Biased Safe Operating Area (Note E)

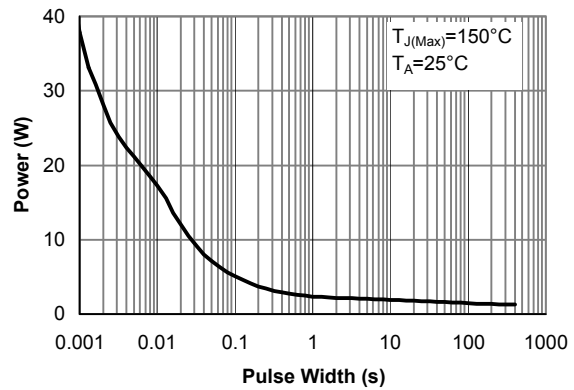

Figure 10: Single Pulse Power Rating Junction-to-Ambient (Note E)

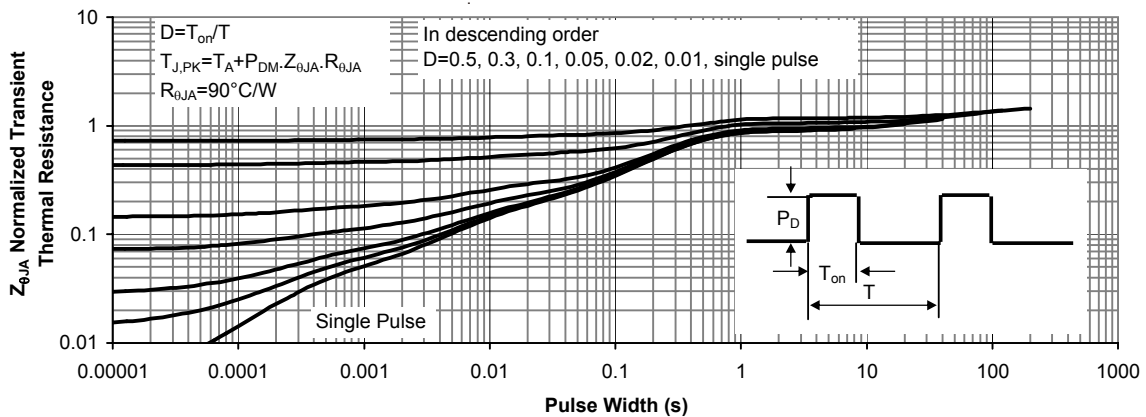
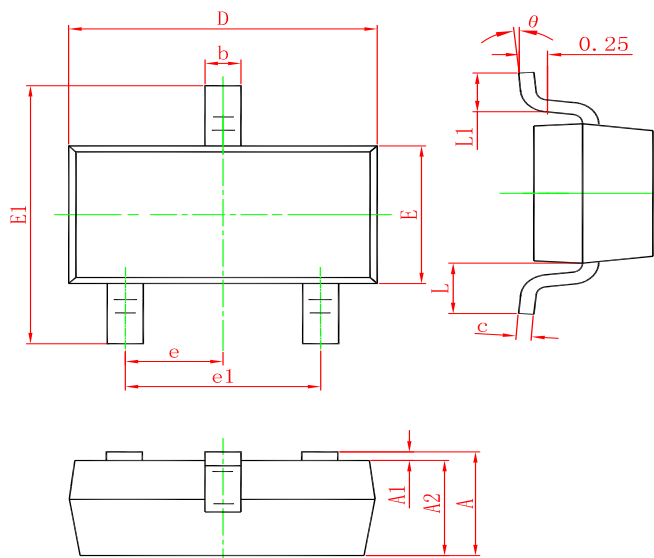

Figure 11: Normalized Maximum Transient Thermal Impedance

SOT-23 PACKAGE OUTLINE DIMENSIONS



Symbol	Dimensions In Millimeters		Dimensions In Inches	
	Min.	Max.	Min.	Max.
A	0.900	1.150	0.035	0.045
A1	0.000	0.100	0.000	0.004
A2	0.900	1.050	0.035	0.041
b	0.300	0.500	0.012	0.020
c	0.080	0.150	0.003	0.006
D	2.800	3.000	0.110	0.118
E	1.200	1.400	0.047	0.055
E1	2.250	2.550	0.089	0.100
e	0.950 TYP.		0.037 TYP.	
e1	1.800	2.000	0.071	0.079
L	0.550 REF.		0.022 REF.	
L1	0.300	0.500	0.012	0.020
θ	0°	8°	0°	8°

Marking

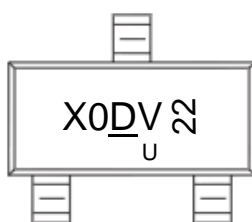

Ordering information

Order code	Package	Baseqty	Deliverymode
UMW AO3400A	SOT-23	3000	Tape and reel