

FEATURES

- Ideally suited for automatic insertion
- For Switching and AF Amplifier Applications

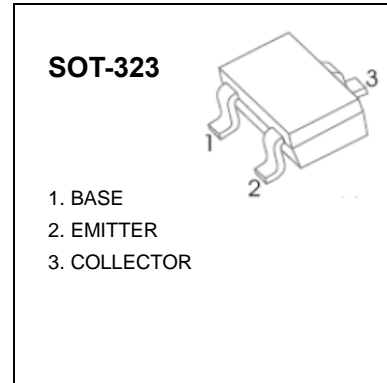

MAXIMUM RATINGS (T_a=25°C unless otherwise noted)

Symbol	Parameter	Value	Unit
V _{CB0}	Collector-Base Voltage	50	V
V _{CEO}	Collector-Emitter Voltage	45	V
V _{EBO}	Emitter-Base Voltage	6	V
I _C	Collector Current –Continuous	0.1	A
P _C	Collector Power Dissipation	150	mW
R _{θJA}	Thermal Resistance From Junction To Ambient	833	°C/W
T _J , T _{stg}	Operation Junction and Storage Temperature Range	-55-150	°C

ELECTRICAL CHARACTERISTICS (T_a=25°C unless otherwise specified)

Parameter	Symbol	Test conditions	Min	Typ	Max	Unit
Collector-base breakdown voltage	V _{CBO}	I _C = 10μA, I _E =0	50			V
Collector-emitter breakdown voltage	V _{CEO}	I _C = 10mA, I _B =0	45			V
Emitter-base breakdown voltage	V _{EBO}	I _E = 1 μA, I _C =0	6			V
Collector Cutoff Current	I _{CB0}	V _{CB} =30V			15	nA
DC current gain	h _{FE}	V _{CE} = 5V, I _C = 10μA V _{CE} = 5V, I _C = 2mA		150 200		450
Collector-emitter saturation voltage	V _{CE(sat)}	I _C =10mA, I _B =0. 5mA I _C =100mA, I _B = 5mA			0.25 0.6	V
Base-emitter saturation voltage	V _{BE(sat)}	I _C =10mA, I _B =0. 5mA I _C =100mA, I _B = 5mA		0.7 0.9		V
Base-emitter voltage	V _{BE(on)}	V _{CE} = 5V, I _C = 2mA V _{CE} = 5V, I _C = 10mA	580	660	700 770	mV
Transition frequency	f _T	V _{CE} = 5 V, I _C = 10mA f=100MHz	100			MHz
Collector output capacitance	C _{ob}	V _{CB} =10V,f=1MHz			4.5	pF
Noise figure	NF	f=1KHz,R _S =2KΩ			10	dB

Typical Characteristics

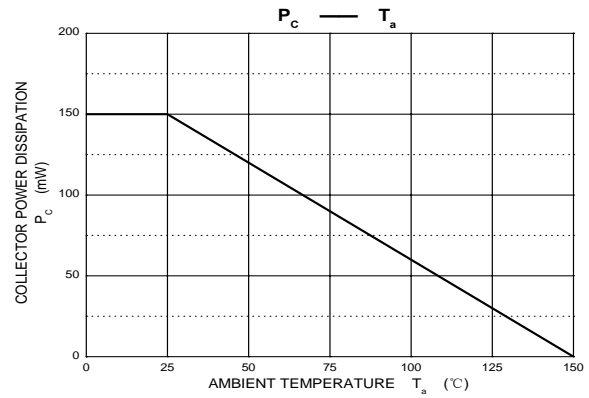
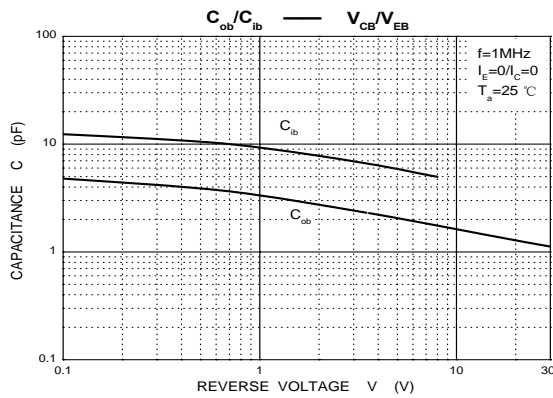
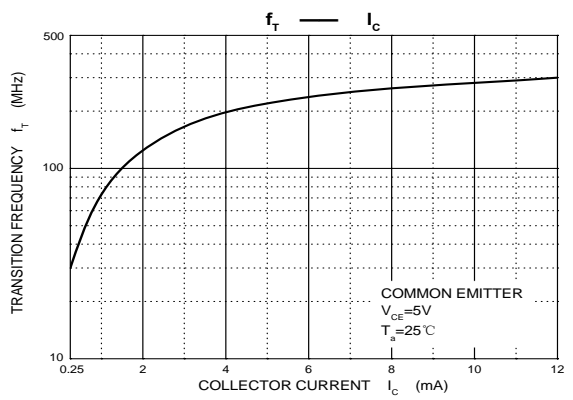
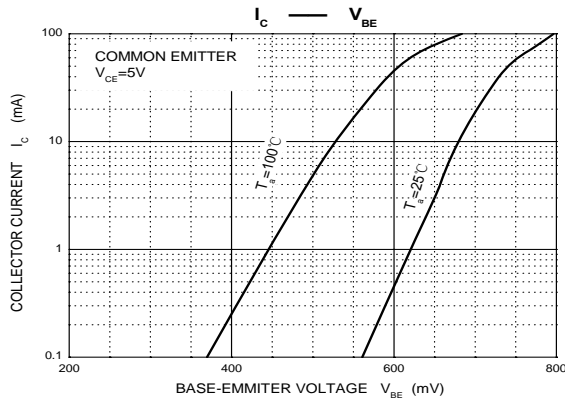
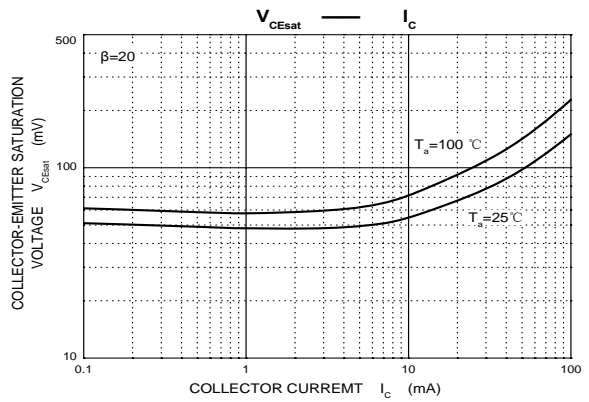
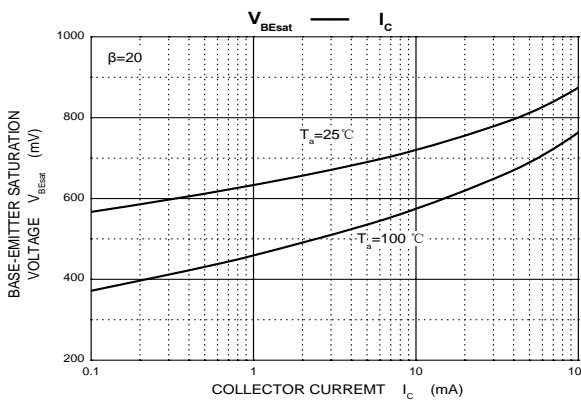
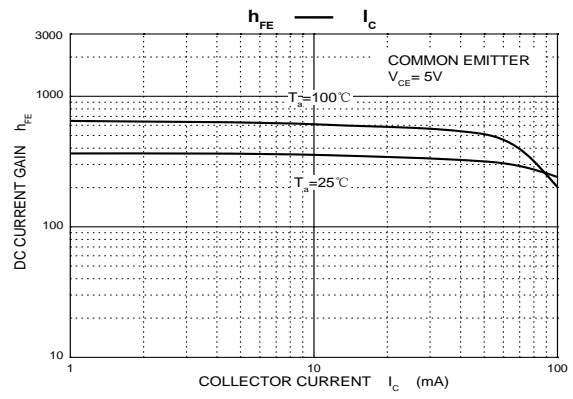
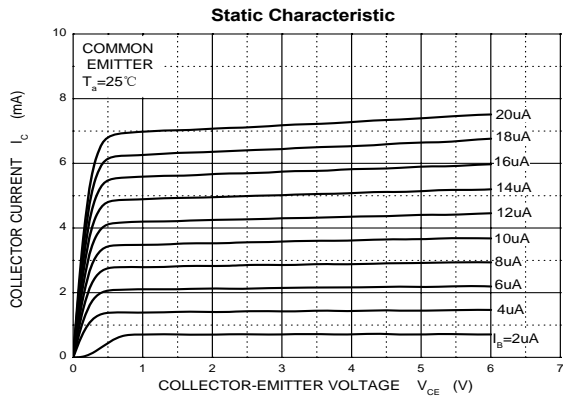

SOT-323 Package Outline Dimensions

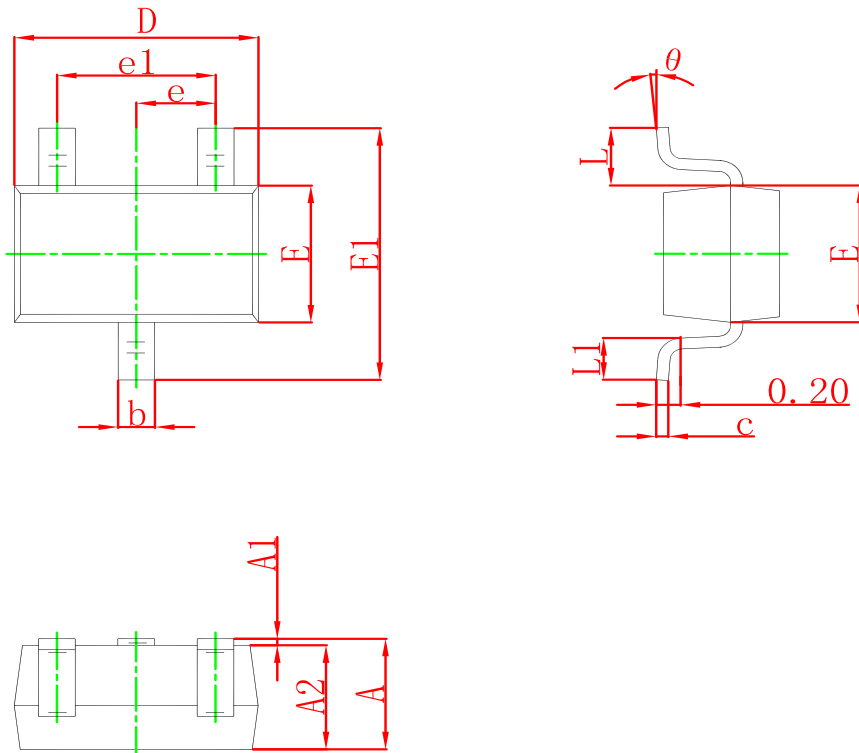

Symbol	Dimensions In Millimeters		Dimensions In Inches	
	Min	Max	Min	Max
A	0.900	1.100	0.035	0.043
A1	0.000	0.100	0.000	0.004
A2	0.900	1.000	0.035	0.039
b	0.200	0.400	0.008	0.016
c	0.080	0.150	0.003	0.006
D	2.000	2.200	0.079	0.087
E	1.150	1.350	0.045	0.053
E1	2.150	2.450	0.085	0.096
e	0.650 TYP		0.026 TYP	
e1	1.200	1.400	0.047	0.055
L	0.525 REF		0.021 REF	
L1	0.260	0.460	0.010	0.018
θ	0°	8°	0°	8°

Marking

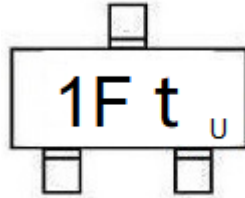

Ordering information

Order code	Package	Baseqty	Deliverymode
UMW BC847BW	SOT-323	3000	Tape and reel