



PRODUCT DATA SHEET



To learn more about JGSEMI, please visit our website at



Datasheet



Resources



Samples

Please note: Please check the JINGAO Semiconductor website to verify the updated device numbers. The most current and up-to-date ordering information can be found at www.jg-semi.cn. Please email any questions regarding the system integration to JINGAO_questions@jgsemi.com.

General Description

These Dual P-Channel enhancement mode power field effect transistors are using trench DMOS technology. This advanced technology has been especially tailored to minimize on-state resistance, provide superior switching performance, and withstand high energy pulse in the avalanche and commutation mode. These devices are well suited for high efficiency fast switching applications.

BVDSS	RDSON	ID
-30V	45mΩ	-5.5A

Features

- -30V, -5.5A, $R_{DS(ON)} = 45m\Omega @ V_{GS} = -10V$
- Fast switching
- Green Device Available
- Suit for -4.5V Gate Drive Applications

Dual SOP8 Pin Configuration

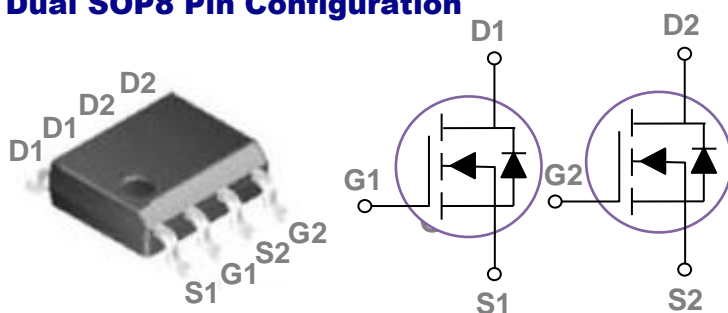

Applications

- Notebook
- Load Switch
- Battery Protection
- Hand-held Instruments

Absolute Maximum Ratings $T_c=25^\circ\text{C}$ unless otherwise noted

Symbol	Parameter	Rating	Units
V_{DS}	Drain-Source Voltage	-30	V
V_{GS}	Gate-Source Voltage	± 20	V
I_D	Drain Current – Continuous ($T_c=25^\circ\text{C}$)	-5.5	A
	Drain Current – Continuous ($T_c=100^\circ\text{C}$)	-3.48	A
I_{DM}	Drain Current – Pulsed ¹	-22	A
P_D	Power Dissipation ($T_c=25^\circ\text{C}$)	2.1	W
	Power Dissipation – Derate above 25°C	0.017	W/ $^\circ\text{C}$
T_{STG}	Storage Temperature Range	-55 to 150	$^\circ\text{C}$
T_J	Operating Junction Temperature Range	-55 to 125	$^\circ\text{C}$

Thermal Characteristics

Symbol	Parameter	Typ.	Max.	Unit
$R_{\theta JA}$	Thermal Resistance Junction to ambient	---	60	$^\circ\text{C/W}$

Electrical Characteristics (T_J=25 °C, unless otherwise noted)
Off Characteristics

Symbol	Parameter	Conditions	Min.	Typ.	Max.	Unit
BV _{DSS}	Drain-Source Breakdown Voltage	V _{GS} =0V, I _D =-250uA	-30	---	---	V
ΔBV _{DSS} /ΔT _J	BV _{DSS} Temperature Coefficient	Reference to 25°C, I _D =-1mA	---	-0.03	---	V/°C
I _{DSS}	Drain-Source Leakage Current	V _{DS} =-30V, V _{GS} =0V, T _J =25°C	---	---	-1	uA
		V _{DS} =-24V, V _{GS} =0V, T _J =125°C	---	---	-10	uA
I _{GSS}	Gate-Source Leakage Current	V _{GS} =±20V, V _{DS} =0V	---	---	±100	nA

On Characteristics

R _{DS(ON)}	Static Drain-Source On-Resistance	V _{GS} =-10V, I _D =-3A	---	45	55	mΩ
		V _{GS} =-4.5V, I _D =-2A	---	65	80	mΩ
V _{GS(th)}	Gate Threshold Voltage	V _{GS} =V _{DS} , I _D =-250uA	-1.0	-1.6	-2.5	V
ΔV _{GS(th)}	V _{GS(th)} Temperature Coefficient		---	4	---	mV/°C
gfs	Forward Transconductance	V _{DS} =-10V, I _D =-3A	---	3.5	---	S

Dynamic and switching Characteristics

Q _g	Total Gate Charge ^{2,3}	V _{DS} =-15V, V _{GS} =-4.5V, I _D =-3A	---	5.1	---	nC
Q _{gs}	Gate-Source Charge ^{2,3}		---	2	---	
Q _{gd}	Gate-Drain Charge ^{2,3}		---	2.2	---	
T _{d(on)}	Turn-On Delay Time ^{2,3}	V _{DD} =-15V, V _{GS} =-10V, R _G =6Ω I _D =-1A	---	3.4	---	ns
T _r	Rise Time ^{2,3}		---	10.8	---	
T _{d(off)}	Turn-Off Delay Time ^{2,3}		---	26.9	---	
T _f	Fall Time ^{2,3}		---	6.9	---	
C _{iss}	Input Capacitance	V _{DS} =-15V, V _{GS} =0V, F=1MHz	---	560	---	pF
C _{oss}	Output Capacitance		---	55	---	
C _{rss}	Reverse Transfer Capacitance		---	40	---	

Drain-Source Diode Characteristics and Maximum Ratings

Symbol	Parameter	Conditions	Min.	Typ.	Max.	Unit
I _S	Continuous Source Current	V _G =V _D =0V, Force Current	---	---	-5.5	A
I _{SM}	Pulsed Source Current		---	---	-11	A
V _{SD}	Diode Forward Voltage	V _{GS} =0V, I _S =-1A, T _J =25°C	---	---	-1.2	V

Note :

1. Repetitive Rating : Pulsed width limited by maximum junction temperature.
2. The data tested by pulsed , pulse width ≤ 300us , duty cycle ≤ 2%.
3. Essentially independent of operating temperature.

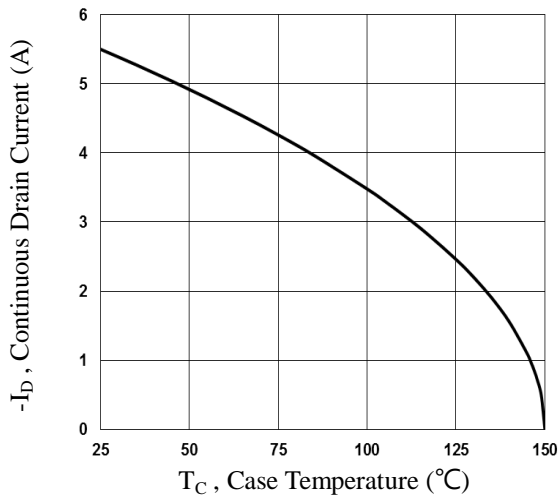
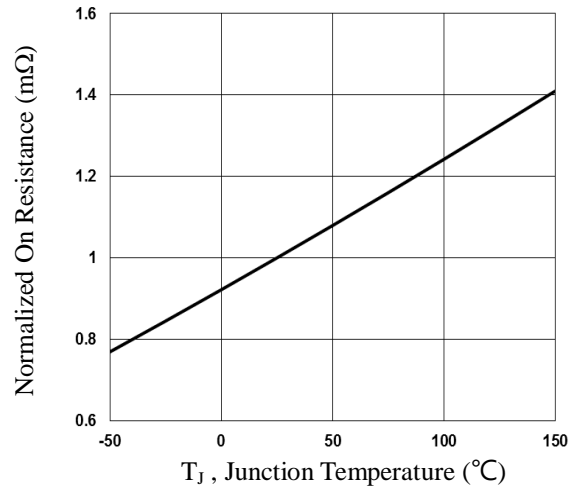
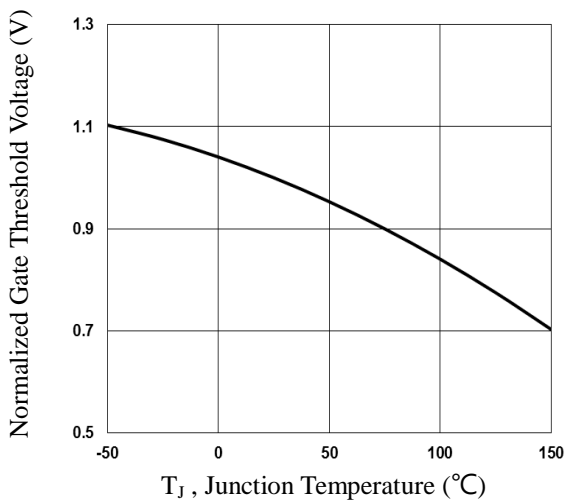
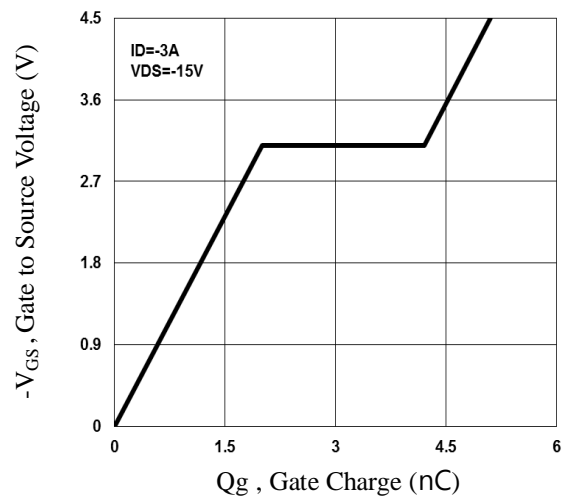
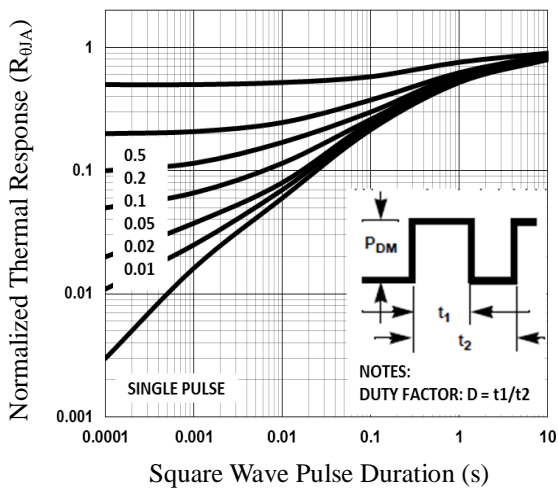
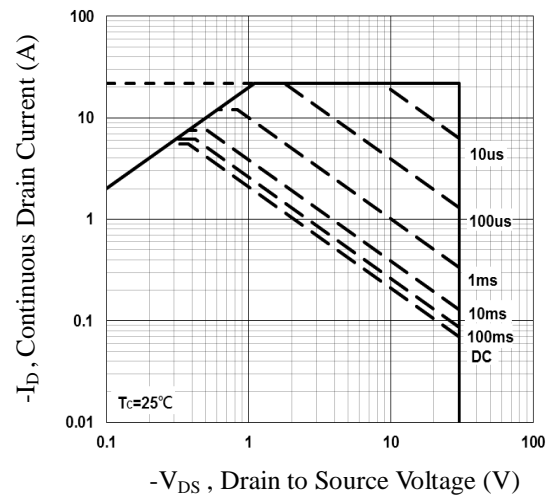
Fig.1 Continuous Drain Current vs. T_C

Fig.2 Normalized $R_{DS(on)}$ vs. T_J

Fig.3 Normalized V_{th} vs. T_J

Fig.4 Gate Charge Waveform

Fig.5 Normalized Transient Impedance

Fig.6 Maximum Safe Operation Area

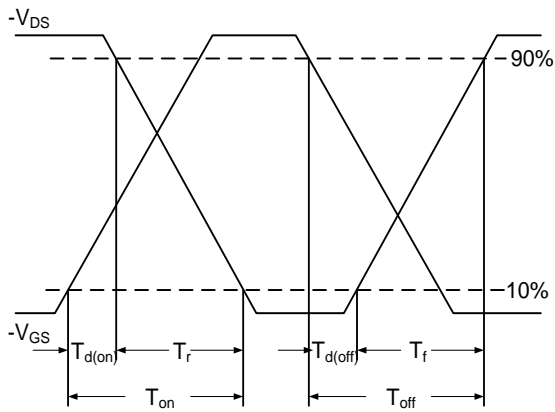

Fig.7 Switching Time Waveform

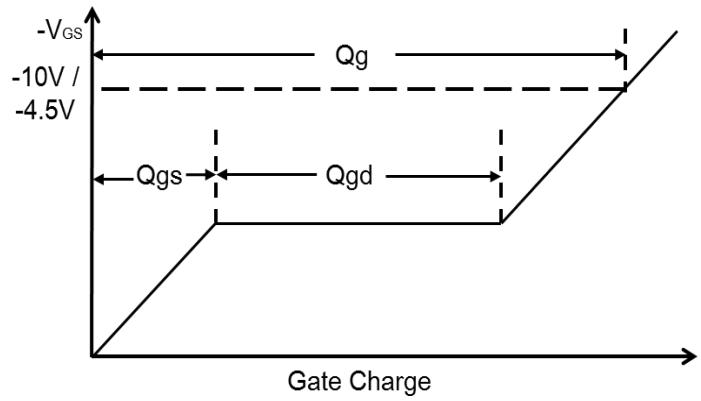
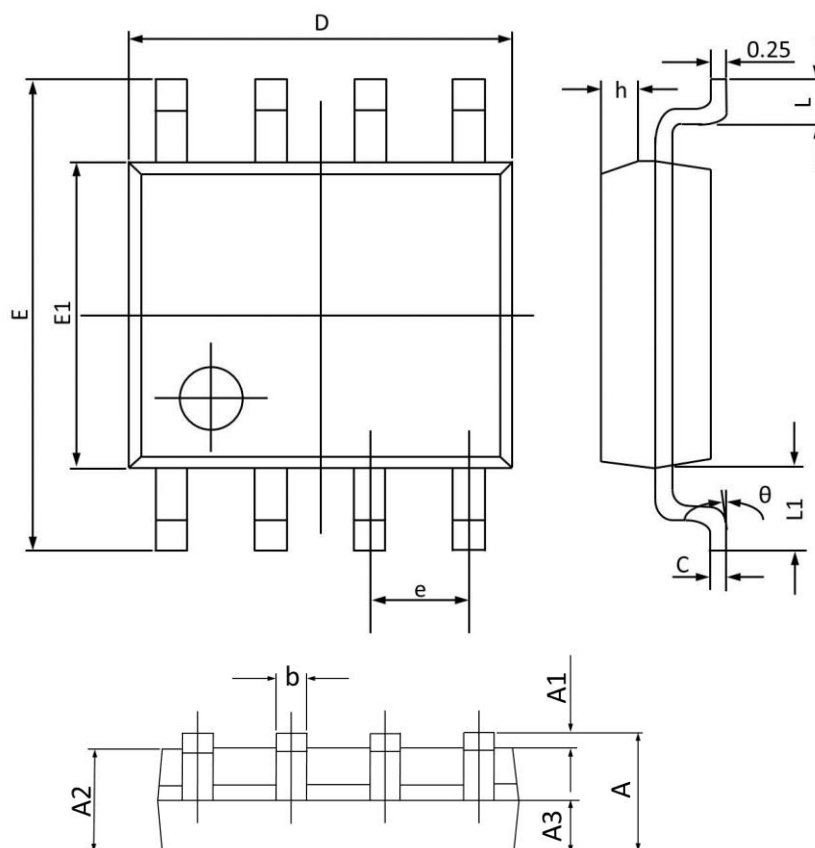

Fig.8 Gate Charge Waveform

SOP8 PACKAGE INFORMATION



Symbol	Dimensions In Millimeters		Dimensions In Inches	
	Min	Max	Min	Max
A	1.350	1.750	0.053	0.068
A1	0.100	0.250	0.004	0.009
A2	1.300	1.500	0.052	0.059
A3	0.600	0.700	0.024	0.027
b	0.390	0.480	0.016	0.018
c	0.210	0.260	0.009	0.010
D	4.700	5.100	0.186	0.200
E	5.800	6.200	0.229	0.244
E1	3.700	4.100	0.146	0.161
e	1.270(BSC)		0.050(BSC)	
h	0.250	0.500	0.010	0.019
L	0.500	0.800	0.019	0.031
L1	1.050(BSC)		0.041(BSC)	
θ	0°	8°	0°	8°

Attention

1, Any and all JGSEMI products described or contained herein do not have specifications that can handle applications that require extremely high levels of reliability, such as life-support systems, aircraft's control systems, or other applications whose failure can be reasonably expected to result in serious physical or material damage. Consult with your JGSEMI representative nearest you before using any JGSEMI products described or contained herein in such applications.

2, JGSEMI assumes no responsibility for equipment failures that result from using products at values that exceed, even momentarily, rated values (such as maximum ratings, operating condition ranges, or other parameters) listed in products specifications of any and all JGSEMI products described or contained herein.

3, Specifications of any and all JGSEMI products described or contained herein stipulate the performance, characteristics, and functions of the described products in the independent state, and are not guarantees of the performance, characteristics, and functions of the described products as mounted in the customer's products or equipment. To verify symptoms and states that cannot be evaluated in an independent device, the customer should always evaluate and test devices mounted in the customer's products or equipment.

4, In the event that any or all JGSEMI products (including technical data, services) described or contained herein are controlled under any of applicable local export control laws and regulations, such products must not be exported without obtaining the export license from the authorities concerned in accordance with the above law.

5, No part of this publication may be reproduced or transmitted in any form or by any means, electronic or mechanical, including photocopying and recording, or any information storage or retrieval system, or otherwise, without the prior written permission of JGSEMI Semiconductor CO., LTD.

6, Any and all information described or contained herein are subject to change without notice due to product technology improvement, etc. When designing equipment, refer to the "Delivery Specification" for the JGSEMI product that you intend to use.