

P-Channel 40-V (D-S) MOSFET

PRODUCT SUMMARY			
V _{DS} (V)	R _{DS(on)} (Ω)	I _D (A)	Q _g (TYP.)
-40	0.0081 at V _{GS} = -10 V	-50 ^d	60
	0.0117 at V _{GS} = -4.5 V	-48 ^d	

FEATURES

- TrenchFET® power MOSFET
- 100 % R_g and UIS tested
- Material categorization: for definitions of compliance please see www.vishay.com/doc?99912



RoHS
COMPLIANT
HALOGEN
FREE

APPLICATIONS

- Power switch
- Load switch in high current applications
- DC/DC converters

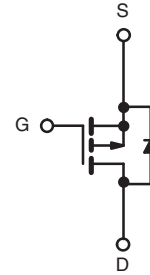
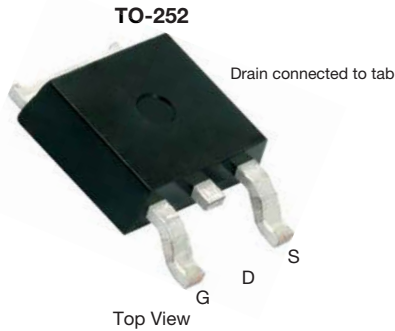

P-Channel MOSFET

Ordering Information:

SUD50P04-08-GE3 (lead (Pb)-free and halogen-free)

ABSOLUTE MAXIMUM RATINGS (T _C = 25 °C, unless otherwise noted)				
PARAMETER	SYMBOL	LIMIT	UNIT	
Drain-Source Voltage	V _{DS}	-40	V	
Gate-Source Voltage	V _{GS}	± 20		
Continuous Drain Current (T _J = 150 °C)	I _D	T _C = 25 °C	A	
		T _C = 70 °C		
Pulsed Drain Current	I _{DM}	-100		
Avalanche Current	I _{AS}	-46		
Single Avalanche Energy ^a	E _{AS}	106	mJ	
Maximum Power Dissipation ^a	P _D	T _C = 25 °C	73.5 ^b	
		T _A = 25 °C ^c	2.5	
Operating Junction and Storage Temperature Range	T _J , T _{stg}	-55 to +150	°C	

THERMAL RESISTANCE RATINGS				
PARAMETER	SYMBOL	LIMIT	UNIT	
Junction-to-Ambient (PCB Mount) ^c	R _{thJA}	50	°C/W	
Junction-to-Case (Drain)	R _{thJC}	1.7		

Notes

- Duty cycle ≤ 1 %.
- See SOA curve for voltage derating.
- When mounted on 1" square PCB (FR-4 material).
- Package limited.



SPECIFICATIONS ($T_J = 25\text{ }^\circ\text{C}$, unless otherwise noted)						
PARAMETER	SYMBOL	TEST CONDITIONS	MIN.	TYP.	MAX.	UNIT
Static						
Drain-Source Breakdown Voltage	V_{DS}	$V_{GS} = 0\text{ V}$, $I_D = -250\text{ }\mu\text{A}$	-40	-	-	V
Gate Threshold Voltage	$V_{GS(th)}$	$V_{DS} = V_{GS}$, $I_D = -250\text{ }\mu\text{A}$	-1	-	-2.5	
Gate-Body Leakage	I_{GSS}	$V_{DS} = 0\text{ V}$, $V_{GS} = \pm 20\text{ V}$	-	-	± 250	nA
Zero Gate Voltage Drain Current	I_{DSS}	$V_{DS} = -40\text{ V}$, $V_{GS} = 0\text{ V}$	-	-	-1	μA
		$V_{DS} = -40\text{ V}$, $V_{GS} = 0\text{ V}$, $T_J = 125\text{ }^\circ\text{C}$	-	-	-50	
		$V_{DS} = -40\text{ V}$, $V_{GS} = 0\text{ V}$, $T_J = 150\text{ }^\circ\text{C}$	-	-	-250	
On-State Drain Current ^a	$I_{D(on)}$	$V_{DS} \leq -10\text{ V}$, $V_{GS} = -10\text{ V}$	-50	-	-	A
Drain-Source On-State Resistance ^a	$R_{DS(on)}$	$V_{GS} = -10\text{ V}$, $I_D = -22\text{ A}$	-	0.0067	0.0081	Ω
		$V_{GS} = -4.5\text{ V}$, $I_D = -19\text{ A}$	-	0.0097	0.0117	
Forward Transconductance ^a	g_{fs}	$V_{DS} = -15\text{ V}$, $I_D = -22\text{ A}$	-	45	-	S
Dynamic ^b						
Input Capacitance	C_{iss}	$V_{GS} = 0\text{ V}$, $V_{DS} = -20\text{ V}$, $f = 1\text{ MHz}$	-	5380	-	μF
Output Capacitance	C_{oss}		-	570	-	
Reverse Transfer Capacitance	C_{rss}		-	500	-	
Total Gate Charge ^c	Q_g	$V_{DS} = -20\text{ V}$, $V_{GS} = -10\text{ V}$, $I_D = -20\text{ A}$	-	106	159	nC
		$V_{DS} = -20\text{ V}$, $V_{GS} = -4.5\text{ V}$, $I_D = -20\text{ A}$	-	60	90	
Gate-Source Charge ^c	Q_{gs}		-	22	-	
Gate-Drain Charge ^c	Q_{gd}		-	27	-	
Gate Resistance	R_g	$f = 1\text{ MHz}$	0.4	1.8	3.6	Ω
Turn-On Delay Time ^c	$t_{d(on)}$	$V_{DD} = -20\text{ V}$, $R_L = 2\text{ }\Omega$ $I_D \cong -10\text{ A}$, $V_{GEN} = -10\text{ V}$, $R_g = 1\text{ }\Omega$	-	15	23	ns
Rise Time ^c	t_r		-	12	18	
Turn-Off Delay Time ^c	$t_{d(off)}$		-	70	105	
Fall Time ^c	t_f		-	18	27	
Drain-Source Body Diode Ratings and Characteristics ($T_C = 25\text{ }^\circ\text{C}$) ^b						
Continuous Current	I_S		-	-	-50	A
Pulsed Current	I_{SM}		-	-	-100	
Forward Voltage ^a	V_{SD}	$I_F = -10\text{ A}$, $V_{GS} = 0\text{ V}$	-	-0.8	-1.5	V
Reverse Recovery Time	t_{rr}	$I_F = -10\text{ A}$, $di/dt = 100\text{ A}/\mu\text{s}$	-	35	53	ns
Peak Reverse Recovery Current	$I_{RM(REC)}$		-	-2	-3	A
Reverse Recovery Charge	Q_{rr}		-	33	50	nC

Notes

- a. Pulse test; pulse width $\leq 300\text{ }\mu\text{s}$, duty cycle $\leq 2\%$.
b. Guaranteed by design, not subject to production testing.
c. Independent of operating temperature.

Stresses beyond those listed under "Absolute Maximum Ratings" may cause permanent damage to the device. These are stress ratings only, and functional operation of the device at these or any other conditions beyond those indicated in the operational sections of the specifications is not implied. Exposure to absolute maximum rating conditions for extended periods may affect device reliability.

TYPICAL CHARACTERISTICS (25 °C, unless otherwise noted)

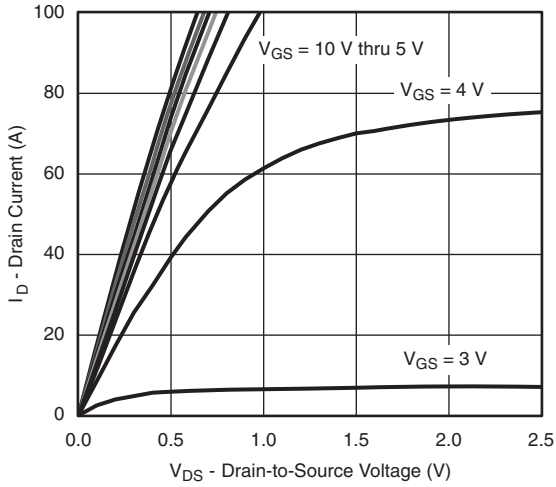

Output Characteristics

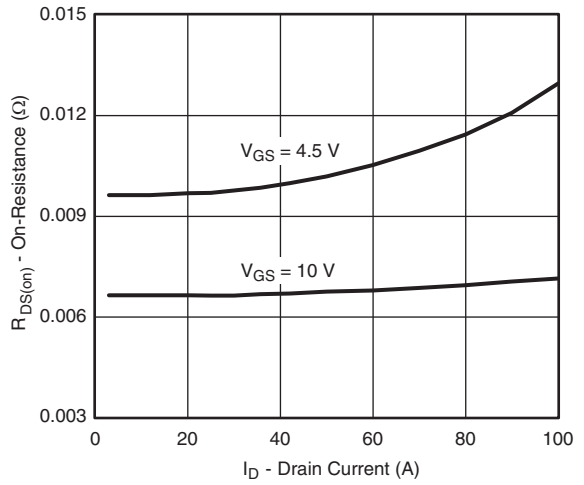

On-Resistance vs. Drain Current

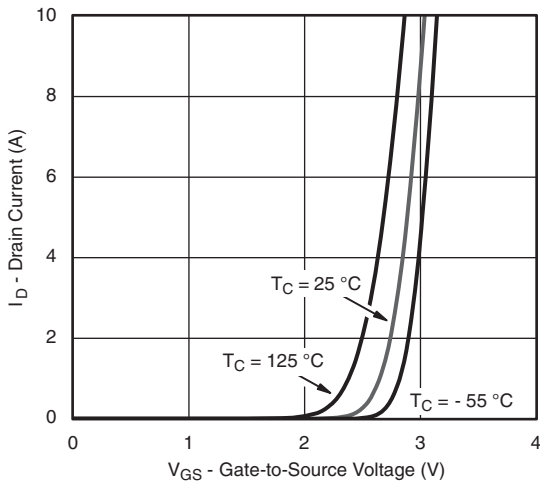

Transfer Characteristics

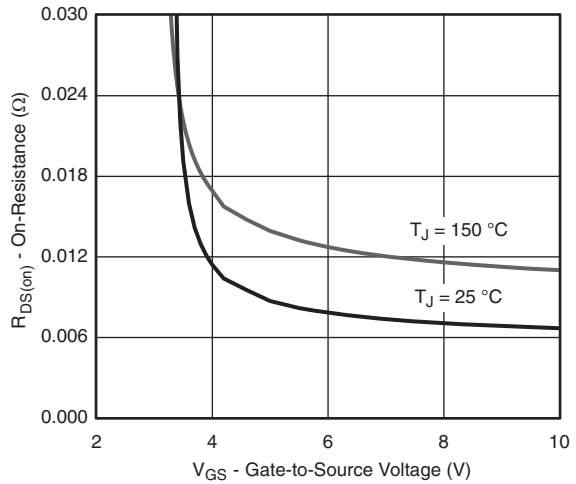

On-Resistance vs. Gate-to-Source Voltage

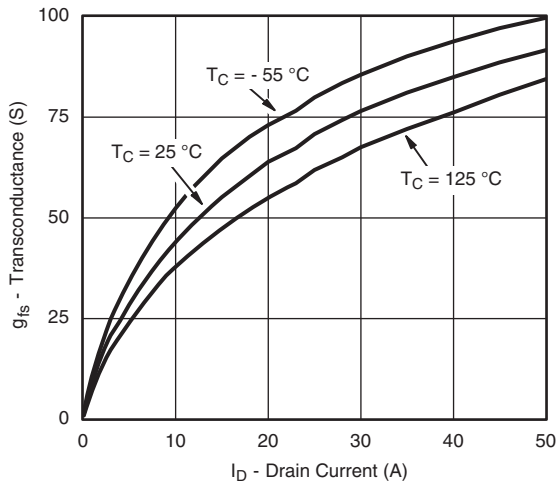

Transconductance

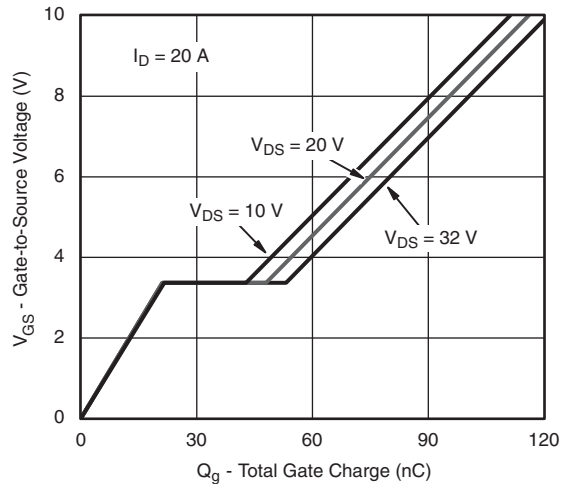

Gate Charge

TYPICAL CHARACTERISTICS (25 °C, unless otherwise noted)

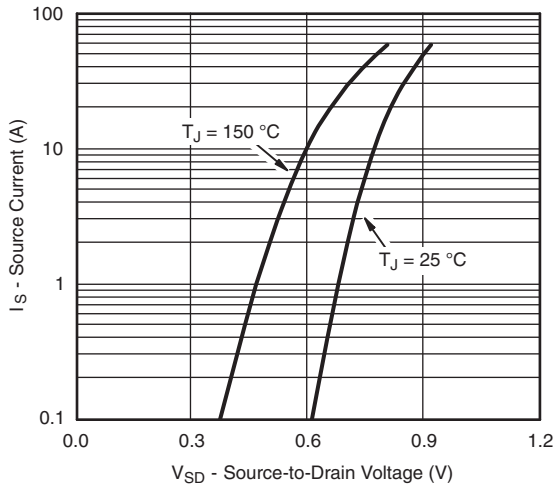

Source-Drain Diode Forward Voltage

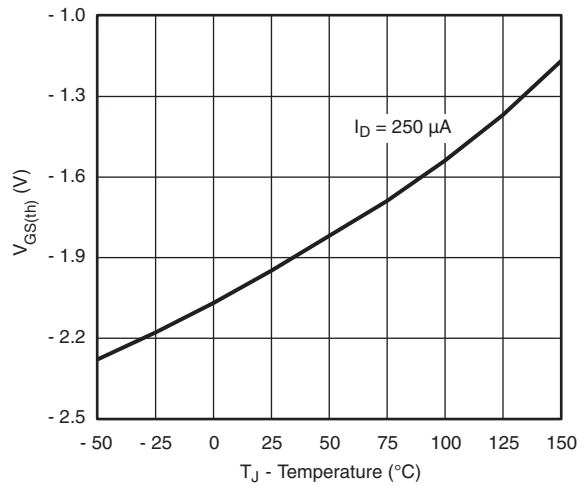

Threshold Voltage

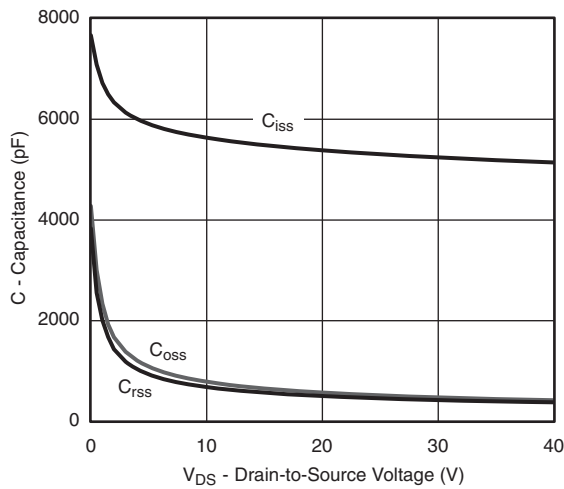

Capacitance

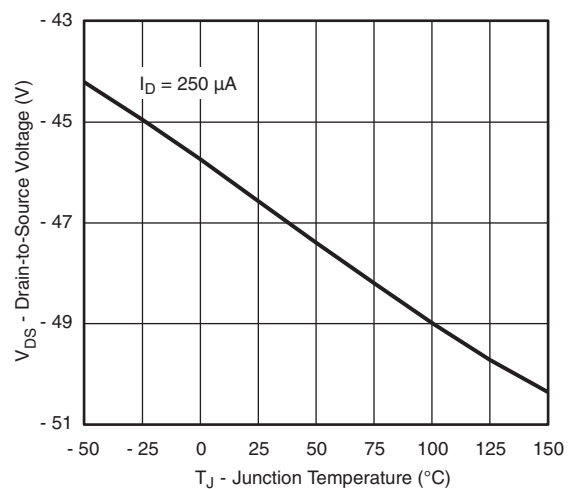

Drain Source Breakdown vs. Junction Temperature

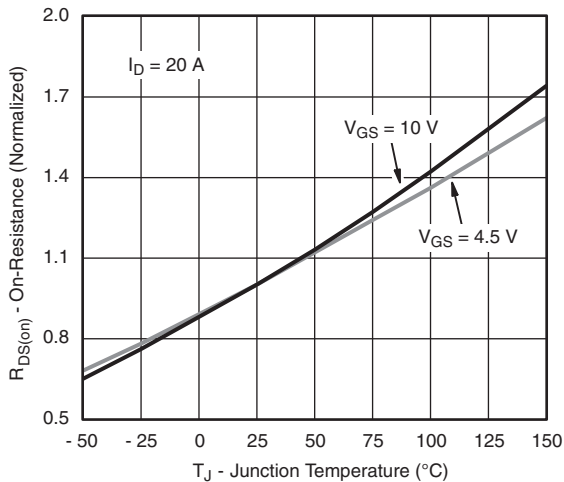

On-Resistance vs. Junction Temperature

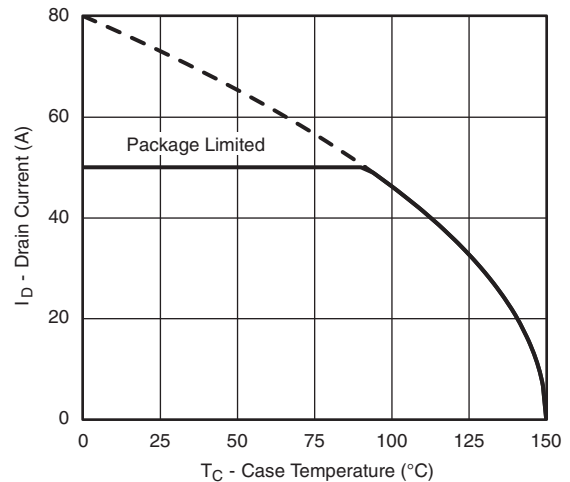

Current Derating



TYPICAL CHARACTERISTICS (25 °C, unless otherwise noted)

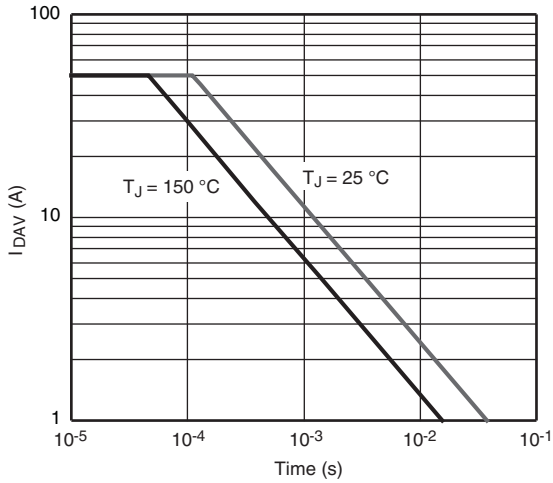

Single Pulse Avalanche Current Capability vs. Time

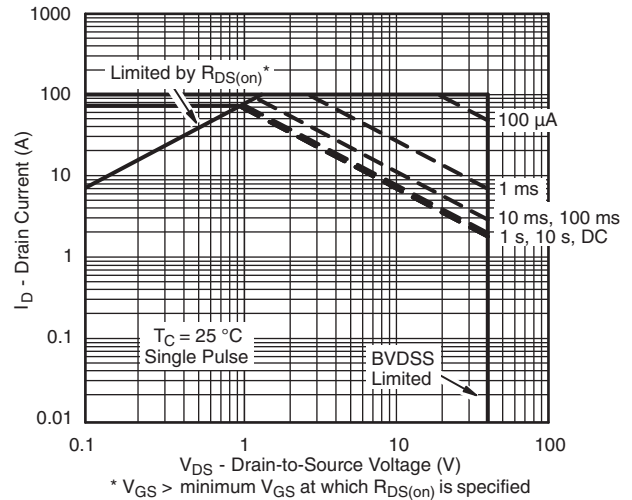

Safe Operating Area

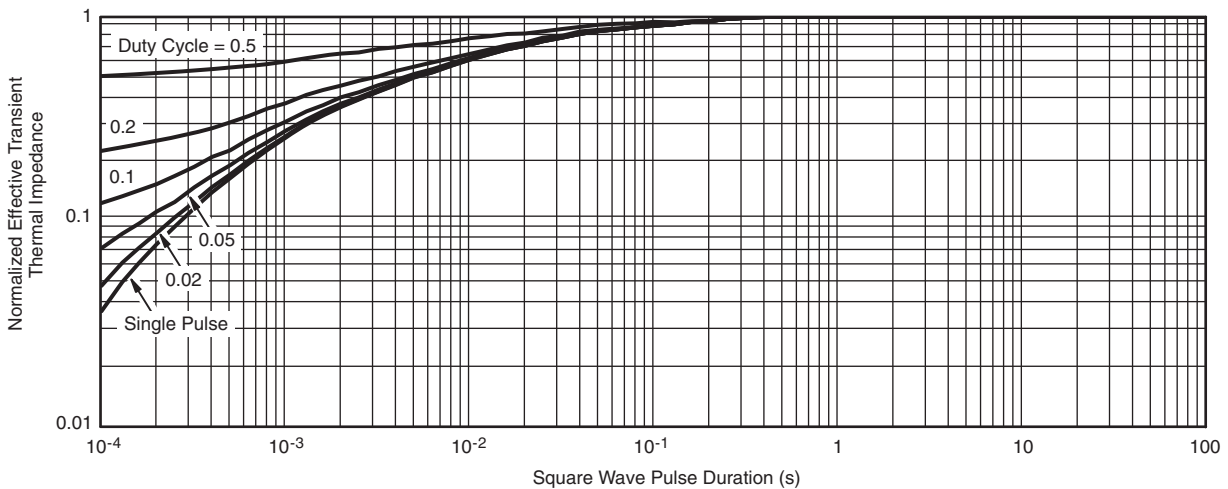

Normalized Thermal Transient Impedance, Junction-to-Case

Vishay Siliconix maintains worldwide manufacturing capability. Products may be manufactured at one of several qualified locations. Reliability data for Silicon Technology and Package Reliability represent a composite of all qualified locations. For related documents such as package/tape drawings, part marking, and reliability data, see www.vishay.com/ppg?65594.



TO-252AA Case Outline

VERSION 1: FACILITY CODE = Y



DIM.	MILLIMETERS	
	MIN.	MAX.
A	2.18	2.38
A1	-	0.127
b	0.64	0.88
b2	0.76	1.14
b3	4.95	5.46
C	0.46	0.61
C2	0.46	0.89
D	5.97	6.22
D1	4.10	-
E	6.35	6.73
E1	4.32	-
H	9.40	10.41
e	2.28 BSC	
e1	4.56 BSC	
L	1.40	1.78
L3	0.89	1.27
L4	-	1.02
L5	1.01	1.52

Note

- Dimension L3 is for reference only



VERSION 2: FACILITY CODE = N

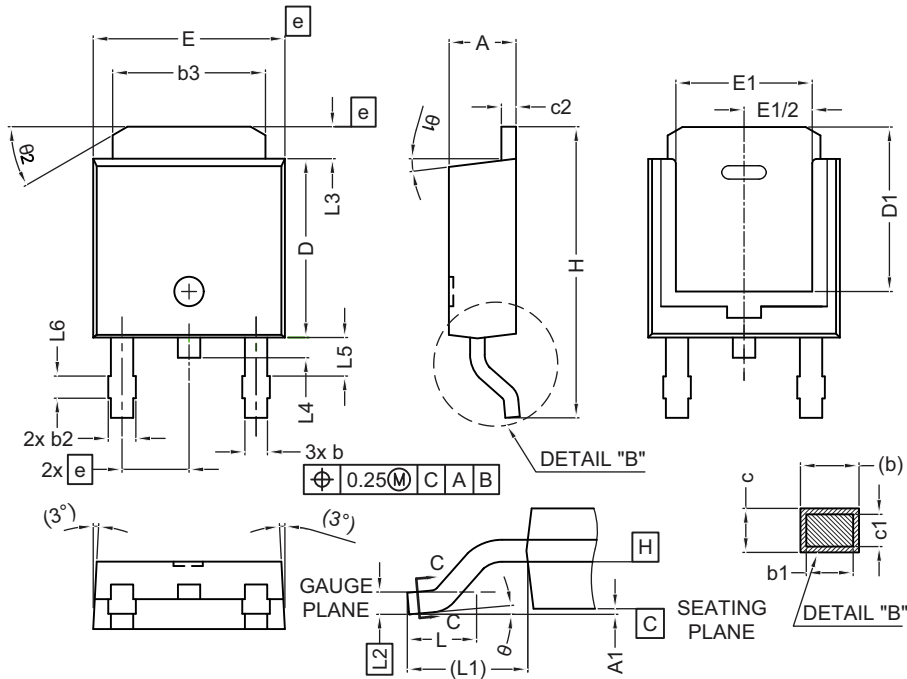

MILLIMETERS		
DIM.	MIN.	MAX.
A	2.18	2.39
A1	-	0.13
b	0.65	0.89
b1	0.64	0.79
b2	0.76	1.13
b3	4.95	5.46
c	0.46	0.61
c1	0.41	0.56
c2	0.46	0.60
D	5.97	6.22
D1	5.21	-
E	6.35	6.73
E1	4.32	-
e	2.29 BSC	
H	9.94	10.34

MILLIMETERS		
DIM.	MIN.	MAX.
L	1.50	1.78
L1	2.74 ref.	
L2	0.51 BSC	
L3	0.89	1.27
L4	-	1.02
L5	1.14	1.49
L6	0.65	0.85
θ	0°	10°
θ1	0°	15°
θ2	25°	35°

Notes

- Dimensioning and tolerance confirm to ASME Y14.5M-1994
- All dimensions are in millimeters. Angles are in degrees
- Heat sink side flash is max. 0.8 mm
- Radius on terminal is optional

ECN: E19-0649-Rev. Q, 16-Dec-2019
 DWG: 5347

RECOMMENDED MINIMUM PADS FOR DPAK (TO-252)



Recommended Minimum Pads
Dimensions in Inches/(mm)

[Return to Index](#)



Disclaimer

ALL PRODUCT, PRODUCT SPECIFICATIONS AND DATA ARE SUBJECT TO CHANGE WITHOUT NOTICE TO IMPROVE RELIABILITY, FUNCTION OR DESIGN OR OTHERWISE.

Vishay Intertechnology, Inc., its affiliates, agents, and employees, and all persons acting on its or their behalf (collectively, "Vishay"), disclaim any and all liability for any errors, inaccuracies or incompleteness contained in any datasheet or in any other disclosure relating to any product.

Vishay makes no warranty, representation or guarantee regarding the suitability of the products for any particular purpose or the continuing production of any product. To the maximum extent permitted by applicable law, Vishay disclaims (i) any and all liability arising out of the application or use of any product, (ii) any and all liability, including without limitation special, consequential or incidental damages, and (iii) any and all implied warranties, including warranties of fitness for particular purpose, non-infringement and merchantability.

Statements regarding the suitability of products for certain types of applications are based on Vishay's knowledge of typical requirements that are often placed on Vishay products in generic applications. Such statements are not binding statements about the suitability of products for a particular application. It is the customer's responsibility to validate that a particular product with the properties described in the product specification is suitable for use in a particular application. Parameters provided in datasheets and / or specifications may vary in different applications and performance may vary over time. All operating parameters, including typical parameters, must be validated for each customer application by the customer's technical experts. Product specifications do not expand or otherwise modify Vishay's terms and conditions of purchase, including but not limited to the warranty expressed therein.

Hyperlinks included in this datasheet may direct users to third-party websites. These links are provided as a convenience and for informational purposes only. Inclusion of these hyperlinks does not constitute an endorsement or an approval by Vishay of any of the products, services or opinions of the corporation, organization or individual associated with the third-party website. Vishay disclaims any and all liability and bears no responsibility for the accuracy, legality or content of the third-party website or for that of subsequent links.

Except as expressly indicated in writing, Vishay products are not designed for use in medical, life-saving, or life-sustaining applications or for any other application in which the failure of the Vishay product could result in personal injury or death. Customers using or selling Vishay products not expressly indicated for use in such applications do so at their own risk. Please contact authorized Vishay personnel to obtain written terms and conditions regarding products designed for such applications.

No license, express or implied, by estoppel or otherwise, to any intellectual property rights is granted by this document or by any conduct of Vishay. Product names and markings noted herein may be trademarks of their respective owners.