

### Package Marking and Ordering Information

Product ID	PACK	Qty (pcs)
BT151	TO-252	2500

### ABSOLUTE MAXIMUM RATINGS (TC=25°C, unless otherwise specified)

SYMBOL	PARAMETER	TEST CONDITION	VALUE	UNIT
V <sub>DRM</sub>	Repetitive Peak off-state voltage	BT151-5	500(Note 2)	V
		BT151-6	650(Note 2)	
		BT151-8	800	
I <sub>T(AV)</sub>	Average On-State Current (half sine wave; T <sub>c</sub> ≤ 109°C)		7.5	A
I <sub>T(RMS)</sub>	RMS forward current(all conduction angles)		8	A
I <sub>TSM</sub>	Non-repetitive peak on-state current (half sine wave; T <sub>J</sub> = 25°C prior to surge)	t = 10ms	100	A
		t = 8.3ms	110	
I <sup>2</sup> t	I <sup>2</sup> t for fusing	t = 10ms	50	A <sup>2</sup> S
di/dt	Critical rate of rise of on-state current, I <sub>TM</sub> = 20A; I <sub>G</sub> = 50mA; di <sub>G</sub> /dt = 50mA/μs		50	A/μs
I <sub>GM</sub>	Peak gate current		2	A
V <sub>GM</sub>	Peak gate voltage		5	V
V <sub>RGM</sub>	Peak Reverse Gate Voltage		5	V
P <sub>G(AV)</sub>	Average gate Power(over any 20ms period)	T <sub>J</sub> = 125°C	0.5	W
P <sub>GM</sub>	Peak gate Power		5	W
T <sub>J</sub>	Operating Junction Temperature		125	°C
T <sub>stg</sub>	Storage Temperature		-40 to +150	°C

Notes: 1. Absolute maximum ratings are those values beyond which the device could be permanently damaged. Absolute maximum ratings are stress ratings only and functional device operation is not implied.

2. Although not recommended, off-state voltages up to 800V may be applied without damage, but the thyristor may switch to the on-state. The rate of rise of current should not exceed 15A/μs.



**THERMAL RESISTANCES**

PARAMETER		SYMBOL	RATINGS	UNIT
Junction to Ambient	TO-252/TO-220F	$R\theta_{JA}$	62.5	$^{\circ}\text{C}/\text{W}$
Junction to Case	TO-220F	$R\theta_{JC}$	3.31	$^{\circ}\text{C}/\text{W}$
	TO-252		2.6	$^{\circ}\text{C}/\text{W}$

**ELECTRICAL CHARACTERISTICS (T<sub>J</sub>=25 $^{\circ}\text{C}$ , unless otherwise specified)**

PARAMETER	SYMBOL	TEST CONDITIONS	MIN	TYP	MAX	UNIT
<b>STATIC CHARACTERISTICS</b>						
Gate trigger current	$I_{GT}$	$V_D=12\text{V}; I_T=0.1\text{A}$		2	15	mA
Gate trigger voltage	$I_L$	$V_D=12\text{V}; I_{GT}=0.1\text{A}$		10	40	mA
Holding current	$I_H$	$V_D=12\text{V}; I_{GT}=0.1\text{A}$		7	20	mA
On-state voltage	$V_T$	$I_T=23\text{A}$		1.4	1.75	V
Gate Trigger Voltage	$V_{GT}$	$V_D=12\text{V}; I_T=0.1\text{A}$		0.6	1.5	V
		$V_D=V_{DRM(max)}; I_T=0.1\text{A}; T_J=125^{\circ}\text{C}$	0.25	0.4	1.3	
Off-State Leakage Current	$I_{DRM}, I_{RRM}$	$V_D=V_{DRM(max)}; V_R=V_{RRM(max)}; T_J=125^{\circ}\text{C}$		0.1	0.5	mA
<b>DYNAMIC CHARACTERISTICS</b>						
Critical Rate of Rise of off-state Voltage	$dV_D/dt$	$V_{DM}=67\%V_{DRM(max)}$ , Exponential waveform, $T_J=125^{\circ}$	Gate open circuit	50	130	V/ $\mu\text{s}$
			$R_{GK}=100\Omega$	200	1000	
Gate Controlled Turn-on Time	$t_{gt}$	$I_{TM}=40\text{A}; V_D=V_{DRM}; I_G=0.1\text{mA}; dI_G/dt=5\text{A}/\mu\text{s}$		2		$\mu\text{s}$
Circuit Commutated Turn-off time	$t_Q$	$V_D = 67\% V_{DRM(max)}; T_J = 125^{\circ}\text{C}; I_{TM} = 20\text{A}$ $V_R = 25\text{V}; dI_{TM}/dt = 30\text{A}/\mu\text{s}; dV_D/dt = 50\text{V}/\mu\text{s}$ $R_{GK} = 100\Omega$		70		$\mu\text{s}$





**TYPICAL CHARACTERISTICS(1)**

Fig 1. Maximum On-State Dissipation,  $p_{tot}$ , Versus Average On-State Current,  $I_{T(AV)}$ , Where  $a$ =form factor= $I_{T(RMS)}/I_{T(AV)}$

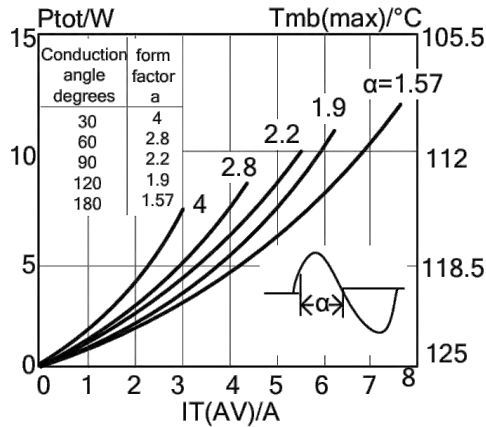

Fig 2. Maximum Permissible Non-Repetitive Peak On-State Current  $I_{TSM}$ , Versus Pulse Width  $tp'$  for Sinusoidal Currents,  $tp \leq 10ms$

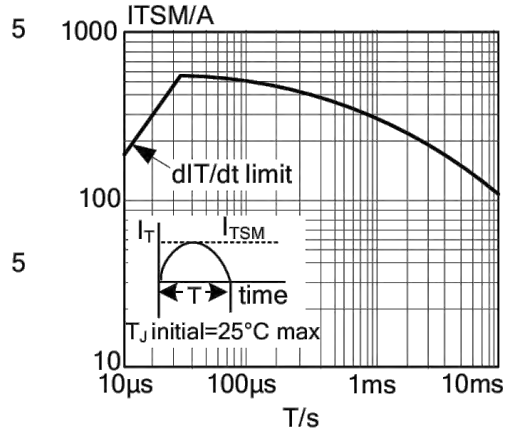

Fig 3. Maximum Permissible Rms Current  $I_{T(RMS)}$ , Versus Mounting Base Temperature  $T_{mb}$

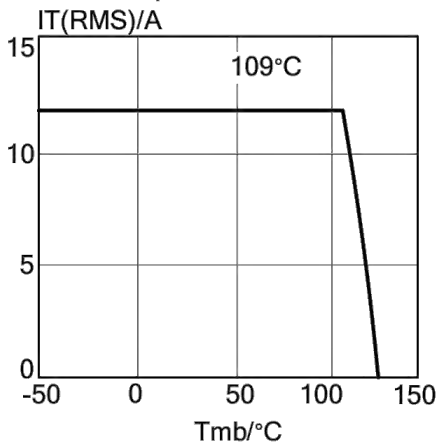

Fig 4. Maximum Permissible Non-Repetitive Peak On-State Current  $I_{TSM}$ , Versus Number Of Cycles, For Sinusoidal Currents,  $f=50HZ$

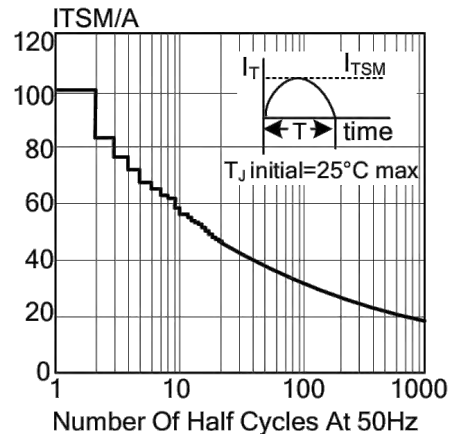

Fig 5. Maximum Permissible Repetitive Rms On-State Current  $I_{T(RMS)}$ , Versus Surge Duration, For Sinusoidal Currents,  $f=50HZ$ ;  $T_{mb} \leq 109°C$

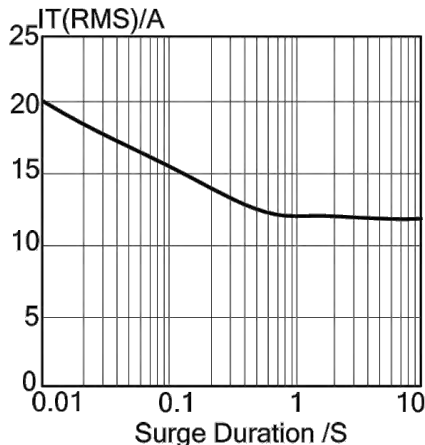
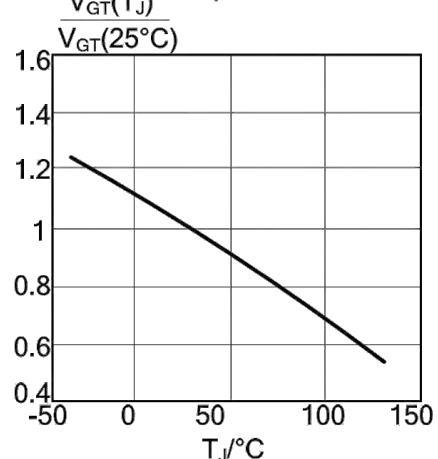

Fig 6. Normalised Gate Trigger Voltage  $V_{GT}(T_J)/V_{GT}(25°C)$ , Versus Junction Temperature  $T_J$





**TYPICAL CHARACTERISTICS(2)**

Fig 7. Normalised Gate Trigger Current  $I_{GT}(T_J)/I_{GT}(25^\circ\text{C})$ , Versus Junction Temperature  $T_J$

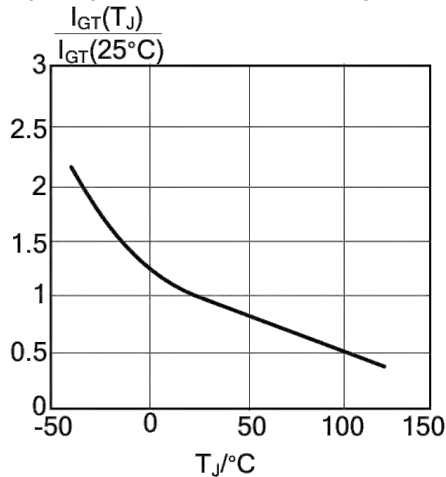

Fig 8. Normalised Latching Current  $I_L(T_J)/I_L(25^\circ\text{C})$ , Versus Junction Temperature  $T_J$

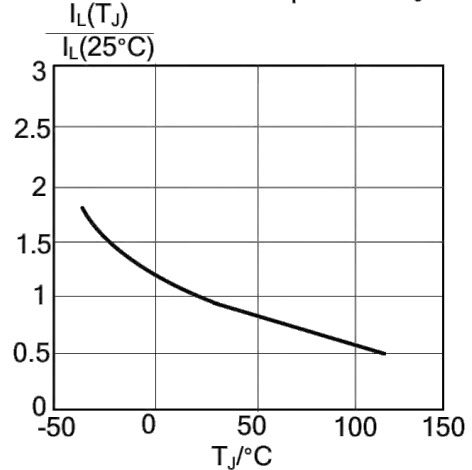

Fig 9. Normalised Holding Current  $I_H(T_J)/I_H(25^\circ\text{C})$ , Versus Junction Temperature  $T_J$

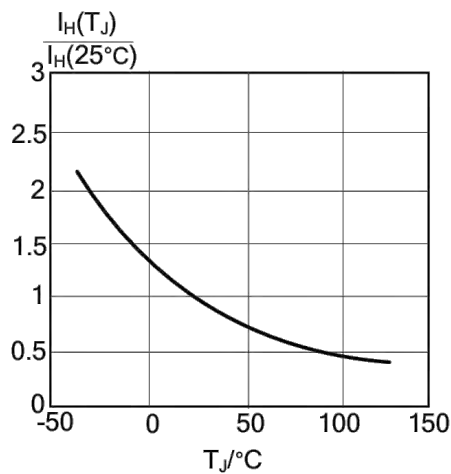

Fig 10. Typical and Maximum On-State Characteristic

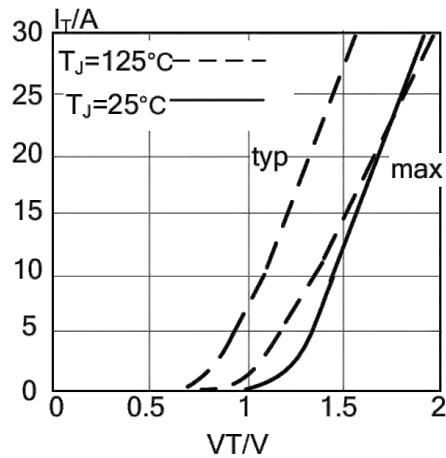

Fig 11. Transient Thermal Impedance  $Z_{thj-mb}$ , Versus Pulse Width  $t_p$

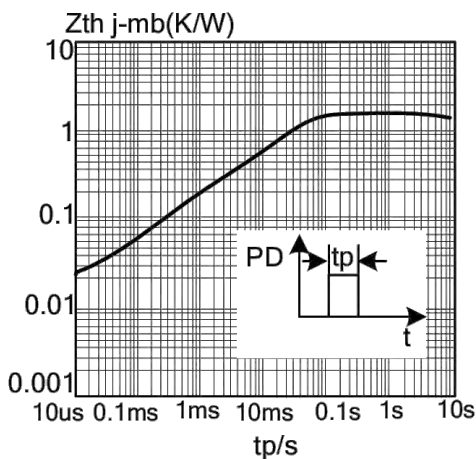
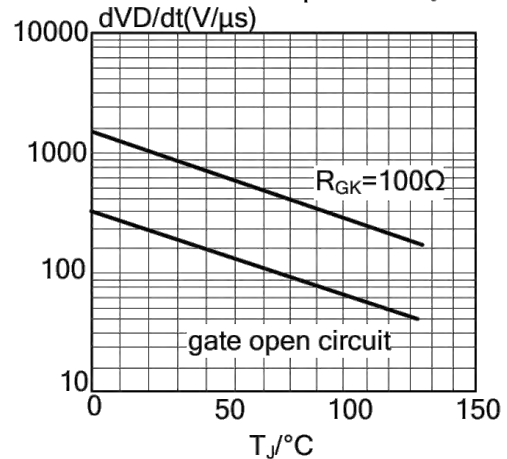
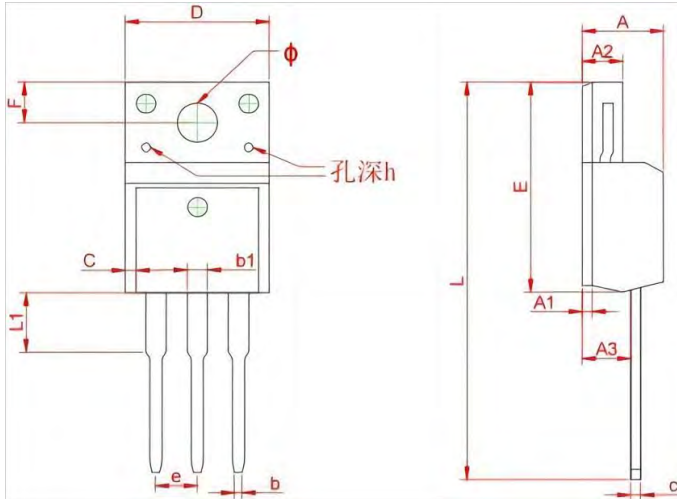

Fig 12. Typical, Critical Rate Of Rise Of Off-State Voltage,  $dV_D/dt$  Versus Junction Temperature  $T_J$





**TO- 220F Package Outline Dimensions**



Symbol	Dimensions In Millimeters		Dimensions In Inches	
	Min.	Max	Min	Max
A	4.300	4.750	0.169	0.185
A1	1.830 REF		0.072 REF	
A2	2.300	2.850	0.090	0.112
A3	2.500	2.900	0.098	0.114
b	0.400	0.420	0.016	0.016
b1	1.220	1.280	0.048	0.050
C	0.690	0.720	0.027	0.028
c	0.490	0.510	0.019	0.020
D	9.960	10.200	0.392	0.400
E	15.000	15.950	0.588	0.625
e	2.574 TYP		0.101TYP	
F	3.470 REF		0.136 REF	
y	3.200 REF		0.125 REF	
h	0.000	0.300	0.000	0.012
L	28.780	28.900	1.128	1.133
L1	2.990	3.100	0.117	0.122

**TO-252-2L Package Outline Dimensions**

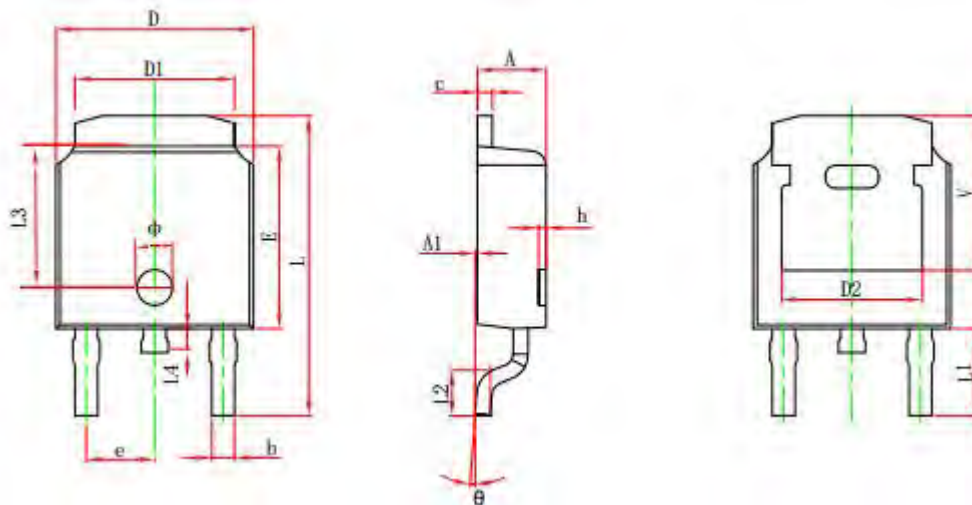

Symbol	Dimensions In Millimeters		Dimensions In Inches	
	Min.	Max.	Min.	Max.
A	2.200	2.400	0.087	0.094
A1	0.000	0.127	0.000	0.005
b	0.635	0.770	0.025	0.030
c	0.460	0.580	0.018	0.023
D	6.500	6.700	0.256	0.264
D1	5.100	5.460	0.201	0.215
D2	4.830 REF.		0.190 REF.	
E	6.000	6.200	0.236	0.244
e	2.186	2.386	0.086	0.094
L	9.712	10.312	0.382	0.406
L1	2.900 REF.		0.114 REF.	
L2	1.400	1.700	0.055	0.067
L3	4.460 REF.		0.1756 REF.	
L4	0.600	1.000	0.024	0.039
φ	1.100	1.300	0.043	0.051
θ	0°	8°	0°	8°
h	0.000	0.300	0.000	0.012
V	5.250 REF.		0.207 REF.	

