

## High Accuracy, Galvanically Isolated Current Sensor IC With Small Footprint SOIC8 Package

### FEATURES AND BENEFITS

- Patented integrated digital temperature compensation circuitry allows for near closed loop accuracy over temperature in an open loop sensor
- UL60950-1 (ed. 2) certified
  - Dielectric Strength Voltage = 2.4 kVrms
  - Basic Isolation Working Voltage = 420 Vpk/297 Vrms
- Industry-leading noise performance with greatly improved bandwidth through proprietary amplifier and filter design techniques
- Pin-selectable band width: 80 kHz for high bandwidth applications or 20 kHz for low noise performance
- 0.65 mΩ primary conductor resistance for low power loss and high inrush current withstand capability
- Small footprint, low-profile SOIC8 package suitable for space-constrained applications
- Integrated shield virtually eliminates capacitive coupling from current conductor to die, greatly suppressing output noise due to high dv/dt transients
- 4.5 to 5.5 V, single supply operation
- Output voltage proportional to AC or DC current
- Factory-trimmed sensitivity and quiescent output voltage

Continued on the next page...

### Package: 8-pin SOIC (suffix LC)

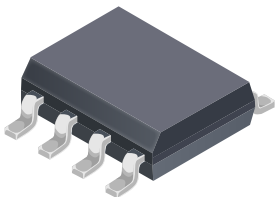

Approximate Scale 1:1

### DESCRIPTION

The Allegro™ ACS723 current sensor IC is an economical and precise solution for AC or DC current sensing in industrial, commercial, and communications systems. The small package is ideal for space constrained applications while also saving costs due to reduced board area. Typical applications include motor control, load detection and management, switched-mode power supplies, and overcurrent fault protection.

The device consists of a precise, low-offset, linear Hall sensor circuit with a copper conduction path located near the surface of the die. Applied current flowing through this copper conduction path generates a magnetic field which is sensed by the integrated Hall IC and converted into a proportional voltage. Device accuracy is optimized through the close proximity of the magnetic field to the Hall transducer. A precise, proportional voltage is provided by the low-offset, chopper-stabilized BiCMOS Hall IC, which includes Allegro's patented digital temperature compensation, resulting in extremely accurate performance over temperature. The output of the device has a positive slope when an increasing current flows through the primary copper conduction path (from pins 1 and 2, to pins 3 and 4), which is the path used for current sensing. The internal resistance of this conductive path is 0.65 mΩ typical, providing low power loss.

The terminals of the conductive path are electrically isolated from the sensor leads (pins 5 through 8). This allows the ACS723 current sensor IC to be used in high-side current sense applications without the use of high-side differential amplifiers or other costly isolation techniques.

Continued on the next page...

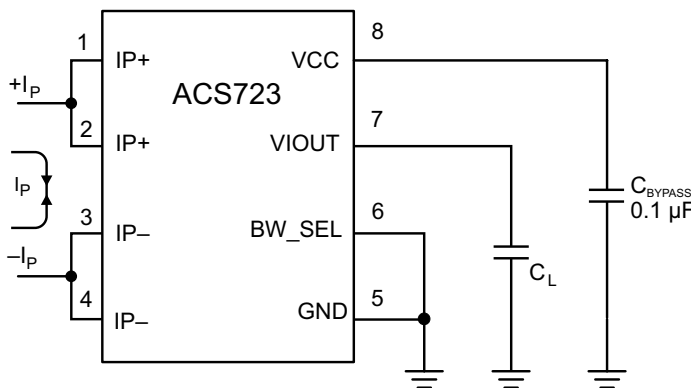

Typical Application

The ACS723 outputs an analog signal,  $V_{IOUT}$ , that changes, proportionally, with the bidirectional AC or DC primary sensed current,  $I_P$ , within the specified measurement range. The BW\_SEL pin can be used to select one of the two bandwidths to optimize the noise performance. Grounding the BW\_SEL pin puts the part in the high bandwidth, 80 kHz, mode.

### Features and Benefits (continued)

- for improved accuracy
- Chopper stabilization results in extremely stable quiescent output voltage
- Nearly zero magnetic hysteresis
- Ratiometric output from supply voltage

### Description (continued)

The ACS723 is provided in a small, low profile surface mount SOIC8 package. The leadframe is plated with 100% matte tin, which is compatible with standard lead (Pb) free printed circuit board assembly processes. Internally, the device is Pb-free, except for flip-chip high-temperature Pb-based solder balls, currently exempt from RoHS. The device is fully calibrated prior to shipment from the factory.

### Selection Guide

| Part Number                     | $I_{PR}$<br>(A) | Sens(Typ)<br>at $V_{CC} = 5.0$ V<br>(mV/A) | $T_A$<br>(°C) | Packing <sup>1</sup>                |
|---------------------------------|-----------------|--|---------------|-------------------------------------|
| ACS723LLCTR-05AB-T <sup>2</sup> | ±5              | 400  | -40 to 150    | Tape and Reel, 3000 pieces per reel |
| ACS723LLCTR-10AU-T <sup>2</sup> | 10              |  |               |                                     |
| ACS723LLCTR-10AB-T <sup>2</sup> | ±10             | 200  |               |                                     |
| ACS723LLCTR-20AU-T <sup>2</sup> | 20              |  |               |                                     |
| ACS723LLCTR-20AB-T <sup>2</sup> | ±20             | 100  |               |                                     |
| ACS723LLCTR-40AU-T <sup>2</sup> | 40              |  |               |                                     |
| ACS723LLCTR-40AB-T <sup>2</sup> | ±40             |  |               |                                     |

<sup>1</sup>Contact Allegro for additional packing options.

<sup>2</sup>Variants not intended for automotive applications.

### SPECIFICATIONS

#### Absolute Maximum Ratings

| Characteristic                | Symbol            | Notes   | Rating     | Units |
|-------------------------------|-------------------|---------|------------|-------|
| Supply Voltage                | $V_{CC}$          |         | 6          | V     |
| Reverse Supply Voltage        | $V_{RCC}$         |         | -0.1       | V     |
| Output Voltage                | $V_{IOUT}$        |         | 25         | V     |
| Reverse Output Voltage        | $V_{RIOUT}$       |         | -0.1       | V     |
| Operating Ambient Temperature | $T_A$             | Range L | -40 to 150 | °C    |
| Junction Temperature          | $T_J(\text{max})$ |         | 165        | °C    |
| Storage Temperature           | $T_{stg}$         |         | -65 to 165 | °C    |

#### Isolation Characteristics

| Characteristic                      | Symbol     | Notes  | Rating | Unit            |
|-------------------------------------|------------|--|--------|-----------------|
| Dielectric Strength Test Voltage    | $V_{ISO}$  | Agency type-tested for 60 seconds per UL 60950-1 (edition. 2). Production tested at VISO for 1 second, in accordance with UL 60950-1 (edition. 2). | 2400   | $V_{RMS}$       |
| Working Voltage for Basic Isolation | $V_{WVBI}$ | Maximum approved working voltage for basic (single) isolation according UL 60950-1 (edition 2).  | 420    | $V_{PK}$ or VDC |
|                                     |            |  | 297    | $V_{RMS}$       |
| Clearance                           | $D_{cl}$   | Minimum distance through air from IP leads to signal leads.  | 3.9    | mm              |
| Creepage                            | $D_{cr}$   | Minimum distance along package body from IP leads to signal leads.   | 3.9    | mm              |

#### Thermal Characteristics

| Characteristic                                   | Symbol          | Test Conditions*  | Value | Units |
|--|-----------------|---|-------|-------|
| Package Thermal Resistance (Junction to Ambient) | $R_{\theta JA}$ | Mounted on the Allegro 85-0593 evaluation board with 400 mm <sup>2</sup> of 4 oz. copper on each side, connected to pins 1 and 2, and to pins 3 and 4, with thermal vias connecting the layers. Performance values include the power consumed by the PCB. | 23    | °C/W  |
| Package Thermal Resistance (Junction to Lead)    | $R_{\theta JL}$ | Mounted on the Allegro ASEK 723 evaluation board.   | 5     | °C/W  |

\*Additional thermal information available on the Allegro website.

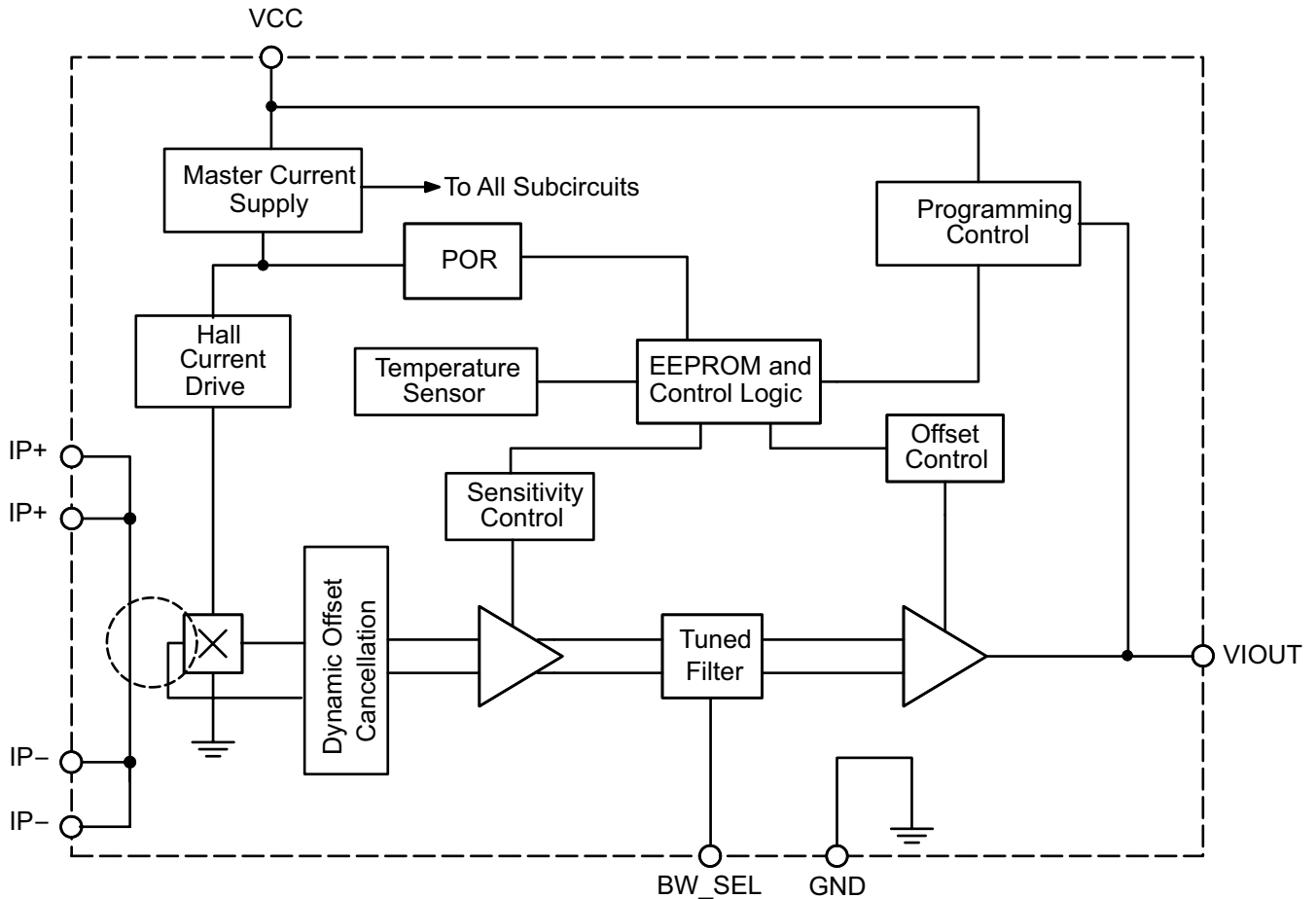

Functional Block Diagram

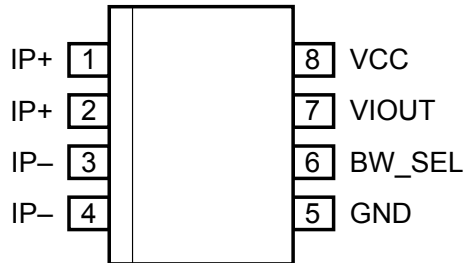
**Pin-out Diagram and Terminal List****Pin-out Diagram****Terminal List Table**

| Number | Name   | Description  |
|--------|--------|--|
| 1, 2   | IP+    | Terminals for current being sensed; fused internally |
| 3, 4   | IP-    | Terminals for current being sensed; fused internally |
| 5      | GND    | Signal ground terminal                               |
| 6      | BW_SEL | Terminal for selecting 20 kHz or 80 kHz bandwidth    |
| 7      | VIOUT  | Analog output signal                                 |
| 8      | VCC    | Device power supply terminal                         |

**COMMON ELECTRICAL CHARACTERISTICS<sup>1</sup>: Valid through the full range of  $T_A = -40^\circ\text{C}$  to  $150^\circ\text{C}$ , and at  $V_{CC} = 5.0\text{ V}$ ; unless otherwise specified**

| Characteristic                  | Symbol                | Test Conditions   | Min.           | Typ.    | Max. | Units   |
|---------------------------------|-----------------------|---|----------------|---------|------|---|
| Supply Voltage                  | $V_{CC}$              |   | 4.5            | 5       | 5.5  | V   |
| Supply Current                  | $I_{CC}$              | $V_{CC}$ within $V_{CC}(\text{min})$ and $V_{CC}(\text{max})$   | –              | 9       | 14   | mA  |
| Output Capacitance Load         | $C_L$                 | VIOUT to GND  | –              | –       | 10   | nF  |
| Output Resistive Load           | $R_L$                 | VIOUT to GND  | 4.7            | –       | –    | k $\Omega$                                    |
| Primary Conductor Resistance    | $R_{IP}$              | $T_A = 25^\circ\text{C}$  | –              | 0.65    | –    | m $\Omega$                                    |
| Magnetic Coupling Factor        | $C_F$                 |   | –              | 10      | –    | G/A   |
| Rise Time                       | $t_r$                 | $I_P = I_P(\text{max})$ , $T_A = 25^\circ\text{C}$ , $C_L = 1\text{ nF}$ ,<br>BW_SEL tied to GND        | –              | 4       | –    | $\mu\text{s}$                                 |
|                                 |                       | $I_P = I_P(\text{max})$ , $T_A = 25^\circ\text{C}$ , $C_L = 1\text{ nF}$ ,<br>BW_SEL tied to VCC        | –              | 17.5    | –    | $\mu\text{s}$                                 |
| Propagation Delay               | $t_{pd}$              | $I_P = I_P(\text{max})$ , $T_A = 25^\circ\text{C}$ , $C_L = 1\text{ nF}$ ,<br>BW_SEL tied to GND        | –              | 1       | –    | $\mu\text{s}$                                 |
|                                 |                       | $I_P = I_P(\text{max})$ , $T_A = 25^\circ\text{C}$ , $C_L = 1\text{ nF}$ ,<br>BW_SEL tied to VCC        | –              | 5       | –    | $\mu\text{s}$                                 |
| Response Time                   | $t_{\text{RESPONSE}}$ | $I_P = I_P(\text{max})$ , $T_A = 25^\circ\text{C}$ , $C_L = 1\text{ nF}$ ,<br>BW_SEL tied to GND        | –              | 5       | –    | $\mu\text{s}$                                 |
|                                 |                       | $I_P = I_P(\text{max})$ , $T_A = 25^\circ\text{C}$ , $C_L = 1\text{ nF}$ ,<br>BW_SEL tied to VCC        | –              | 22.5    | –    | $\mu\text{s}$                                 |
| Internal Bandwidth              | BW <sub>i</sub>       | Small signal –3 dB; $C_L = 1\text{ nF}$ ,<br>BW_SEL tied to GND   | –              | 80      | –    | kHz   |
|                                 |                       | Small signal –3 dB; $C_L = 1\text{ nF}$ ,<br>BW_SEL tied to VCC   | –              | 20      | –    | kHz   |
| Noise Density                   | $I_{ND}$              | Input referenced noise density;<br>$T_A = 25^\circ\text{C}$ , $C_L = 1\text{ nF}$                       | –              | 110     | –    | $\mu\text{A}_{(\text{rms})}/\sqrt{\text{Hz}}$ |
| Noise                           | $I_N$                 | Input referenced noise; BW <sub>i</sub> = 80 kHz,<br>$T_A = 25^\circ\text{C}$ , $C_L = 1\text{ nF}$     | –              | 30      | –    | $\text{mA}_{(\text{rms})}$                    |
|                                 |                       | Input referenced noise; BW <sub>i</sub> = 20 kHz,<br>$T_A = 25^\circ\text{C}$ , $C_L = 1\text{ nF}$     | –              | 15      | –    | $\text{mA}_{(\text{rms})}$                    |
| Nonlinearity                    | $E_{\text{LIN}}$      | Through full range of $I_{PR}$  | –              | $\pm 1$ | –    | %   |
| Saturation Voltage <sup>2</sup> | $V_{OH}$              | $R_L = 4.7\text{ k}\Omega$ , $T_A = 25^\circ\text{C}$   | $V_{CC} - 0.5$ | –       | –    | V   |
|                                 | $V_{OL}$              | $R_L = 4.7\text{ k}\Omega$ , $T_A = 25^\circ\text{C}$   | –              | –       | 0.5  | V   |
| Power-On Time                   | $t_{PO}$              | Output reaches 90% of steady-state level, $T_A = 25^\circ\text{C}$ , $I_P = I_{PR}(\text{max})$ applied | –              | 64      | –    | $\mu\text{s}$                                 |

<sup>1</sup>Device may be operated at higher primary current levels,  $I_P$ , ambient temperatures,  $T_A$ , and internal leadframe temperatures, provided the Maximum Junction Temperature,  $T_J(\text{max})$ , is not exceeded.

<sup>2</sup>The sensor IC will continue to respond to current beyond the range of  $I_P$  until the high or low saturation voltage; however, the nonlinearity in this region will be worse than through the rest of the measurement range.

xLLCTR-5AB PERFORMANCE CHARACTERISTICS:  $T_A$  Range L, valid at  $T_A = -40^\circ\text{C}$  to  $150^\circ\text{C}$ ,  $V_{CC} = 5.0\text{ V}$ , unless otherwise specified

| Characteristic                        | Symbol                   | Test Conditions  | Min. | Typ.                | Max. | Units |
|---------------------------------------|--------------------------|--|------|---------------------|------|-------|
| <b>Nominal Performance</b>            |                          |  |      |                     |      |       |
| Current Sensing Range                 | $I_{PR}$                 |  | -5   | -                   | 5    | A     |
| Sensitivity                           | Sens                     | $I_{PR}(\text{min}) < I_P < I_{PR}(\text{max})$  | -    | 400                 | -    | mV/A  |
| Zero Current Output Voltage           | $V_{IOUT(Q)}$            | Bidirectional; $I_P = 0\text{ A}$  | -    | $V_{CC} \times 0.5$ | -    | V     |
| <b>Accuracy Performance</b>           |                          |  |      |                     |      |       |
| Sensitivity Error                     | $E_{\text{sens}}$        | $T_A = 25^\circ\text{C}$ to $150^\circ\text{C}$ ; measured at $I_P = I_{PR}(\text{max})$   | -2   | -                   | 2    | %     |
|                                       |                          | $T_A = -40^\circ\text{C}$ to $25^\circ\text{C}$ ; ; measured at $I_P = I_{PR}(\text{max})$ | -    | $\pm 2.5$           | -    | %     |
| Offset Voltage <sup>1</sup>           | $V_{OE}$                 | $I_P = 0\text{ A}$ ; $T_A = 25^\circ\text{C}$ to $150^\circ\text{C}$                       | -15  | -                   | 15   | mV    |
|                                       |                          | $I_P = 0\text{ A}$ ; $T_A = -40^\circ\text{C}$ to $25^\circ\text{C}$                       | -    | $\pm 20$            | -    | mV    |
| Total Output Error <sup>2</sup>       | $E_{TOT}$                | $I_P = I_{PR}(\text{max})$ , $T_A = 25^\circ\text{C}$ to $150^\circ\text{C}$               | -2.5 | -                   | 2.5  | %     |
|                                       |                          | $I_P = I_{PR}(\text{max})$ , $T_A = -40^\circ\text{C}$ to $25^\circ\text{C}$               | -    | $\pm 3$             | -    | %     |
| <b>Lifetime Drift Characteristics</b> |                          |  |      |                     |      |       |
| Sensitivity Error Lifetime Drift      | $E_{\text{sens\_drift}}$ |  | -    | $\pm 2$             | -    | %     |
| Total Output Error Lifetime Drift     | $E_{\text{tot\_drift}}$  |  | -    | $\pm 2$             | -    | %     |

<sup>1</sup> Offset Voltage does not incorporate any error due to external magnetic fields. See section: Impact of External Magnetic Fields.

<sup>2</sup> Percentage of  $I_P$ , with  $I_P = I_{PR}(\text{max})$ .

### xLLCTR-10AU PERFORMANCE CHARACTERISTICS, $T_A$ Range L, valid at $T_A = -40^\circ\text{C}$ to $150^\circ\text{C}$ , $V_{CC} = 5.0\text{ V}$ , unless otherwise specified

| Characteristic                        | Symbol                   | Test Conditions  | Min. | Typ.                | Max. | Units |
|---------------------------------------|--------------------------|--|------|---------------------|------|-------|
| <b>Nominal Performance</b>            |                          |  |      |                     |      |       |
| Current Sensing Range                 | $I_{PR}$                 |  | 0    | –                   | 10   | A     |
| Sensitivity                           | Sens                     | $I_{PR}(\text{min}) < I_P < I_{PR}(\text{max})$  | –    | 400                 | –    | mV/A  |
| Zero Current Output Voltage           | $V_{IOUT(Q)}$            | Unidirectional; $I_P = 0\text{ A}$   | –    | $V_{CC} \times 0.1$ | –    | V     |
| <b>Accuracy Performance</b>           |                          |  |      |                     |      |       |
| Sensitivity Error                     | $E_{\text{sens}}$        | $T_A = 25^\circ\text{C}$ to $150^\circ\text{C}$ ; measured at $I_P = I_{PR}(\text{max})$   | –2   | –                   | 2    | %     |
|                                       |                          | $T_A = -40^\circ\text{C}$ to $25^\circ\text{C}$ ; ; measured at $I_P = I_{PR}(\text{max})$ | –    | $\pm 2.5$           | –    | %     |
| Offset Voltage <sup>1</sup>           | $V_{OE}$                 | $I_P = 0\text{ A}$ ; $T_A = 25^\circ\text{C}$ to $150^\circ\text{C}$                       | –15  | –                   | 15   | mV    |
|                                       |                          | $I_P = 0\text{ A}$ ; $T_A = -40^\circ\text{C}$ to $25^\circ\text{C}$                       | –    | $\pm 20$            | –    | mV    |
| Total Output Error <sup>2</sup>       | $E_{TOT}$                | $I_P = I_{PR}(\text{max})$ , $T_A = 25^\circ\text{C}$ to $150^\circ\text{C}$               | –2.5 | –                   | 2.5  | %     |
|                                       |                          | $I_P = I_{PR}(\text{max})$ , $T_A = -40^\circ\text{C}$ to $25^\circ\text{C}$               | –    | $\pm 3$             | –    | %     |
| <b>Lifetime Drift Characteristics</b> |                          |  |      |                     |      |       |
| Sensitivity Error Lifetime Drift      | $E_{\text{sens\_drift}}$ |  | –    | $\pm 2$             | –    | %     |
| Total Output Error Lifetime Drift     | $E_{\text{tot\_drift}}$  |  | –    | $\pm 2$             | –    | %     |

<sup>1</sup> Offset Voltage does not incorporate any error due to external magnetic fields. See section: Impact of External Magnetic Fields.

<sup>2</sup> Percentage of  $I_P$ , with  $I_P = I_{PR}(\text{max})$ .

### xLLCTR-10AB PERFORMANCE CHARACTERISTICS: $T_A$ Range L, valid at $T_A = -40^\circ\text{C}$ to $150^\circ\text{C}$ , $V_{CC} = 5.0\text{ V}$ , unless otherwise specified

| Characteristic                        | Symbol                   | Test Conditions  | Min. | Typ.                | Max. | Units |
|---------------------------------------|--------------------------|--|------|---------------------|------|-------|
| <b>Nominal Performance</b>            |                          |  |      |                     |      |       |
| Current Sensing Range                 | $I_{PR}$                 |  | –10  | –                   | 10   | A     |
| Sensitivity                           | Sens                     | $I_{PR}(\text{min}) < I_P < I_{PR}(\text{max})$  | –    | 200                 | –    | mV/A  |
| Zero Current Output Voltage           | $V_{IOUT(Q)}$            | Bidirectional; $I_P = 0\text{ A}$  | –    | $V_{CC} \times 0.5$ | –    | V     |
| <b>Accuracy Performance</b>           |                          |  |      |                     |      |       |
| Sensitivity Error                     | $E_{\text{sens}}$        | $T_A = 25^\circ\text{C}$ to $150^\circ\text{C}$ ; measured at $I_P = I_{PR}(\text{max})$   | –1.5 | –                   | 1.5  | %     |
|                                       |                          | $T_A = -40^\circ\text{C}$ to $25^\circ\text{C}$ ; ; measured at $I_P = I_{PR}(\text{max})$ | –    | $\pm 2$             | –    | %     |
| Offset Voltage <sup>1</sup>           | $V_{OE}$                 | $I_P = 0\text{ A}$ ; $T_A = 25^\circ\text{C}$ to $150^\circ\text{C}$                       | –10  | –                   | 10   | mV    |
|                                       |                          | $I_P = 0\text{ A}$ ; $T_A = -40^\circ\text{C}$ to $25^\circ\text{C}$                       | –    | $\pm 15$            | –    | mV    |
| Total Output Error <sup>2</sup>       | $E_{TOT}$                | $I_P = I_{PR}(\text{max})$ , $T_A = 25^\circ\text{C}$ to $150^\circ\text{C}$               | –2   | –                   | 2    | %     |
|                                       |                          | $I_P = I_{PR}(\text{max})$ , $T_A = -40^\circ\text{C}$ to $25^\circ\text{C}$               | –    | $\pm 3$             | –    | %     |
| <b>Lifetime Drift Characteristics</b> |                          |  |      |                     |      |       |
| Sensitivity Error Lifetime Drift      | $E_{\text{sens\_drift}}$ |  | –    | $\pm 2$             | –    | %     |
| Total Output Error Lifetime Drift     | $E_{\text{tot\_drift}}$  |  | –    | $\pm 2$             | –    | %     |

<sup>1</sup> Offset Voltage does not incorporate any error due to external magnetic fields. See section: Impact of External Magnetic Fields.

<sup>2</sup> Percentage of  $I_P$ , with  $I_P = I_{PR}(\text{max})$ .



### xLLCTR-20AU PERFORMANCE CHARACTERISTICS: $T_A$ Range L, valid at $T_A = -40^\circ\text{C}$ to $150^\circ\text{C}$ , $V_{CC} = 5.0\text{ V}$ , unless otherwise specified

| Characteristic                        | Symbol                   | Test Conditions  | Min. | Typ.                | Max. | Units |
|---------------------------------------|--------------------------|--|------|---------------------|------|-------|
| <b>Nominal Performance</b>            |                          |  |      |                     |      |       |
| Current Sensing Range                 | $I_{PR}$                 |  | 0    | –                   | 20   | A     |
| Sensitivity                           | Sens                     | $I_{PR}(\text{min}) < I_P < I_{PR}(\text{max})$  | –    | 200                 | –    | mV/A  |
| Zero Current Output Voltage           | $V_{IOUT(Q)}$            | Unidirectional; $I_P = 0\text{ A}$   | –    | $V_{CC} \times 0.1$ | –    | V     |
| <b>Accuracy Performance</b>           |                          |  |      |                     |      |       |
| Sensitivity Error                     | $E_{\text{sens}}$        | $T_A = 25^\circ\text{C}$ to $150^\circ\text{C}$ ; measured at $I_P = I_{PR}(\text{max})$   | –1.5 | –                   | 1.5  | %     |
|                                       |                          | $T_A = -40^\circ\text{C}$ to $25^\circ\text{C}$ ; ; measured at $I_P = I_{PR}(\text{max})$ | –    | $\pm 2$             | –    | %     |
| Offset Voltage <sup>1</sup>           | $V_{OE}$                 | $I_P = 0\text{ A}$ ; $T_A = 25^\circ\text{C}$ to $150^\circ\text{C}$                       | –10  | –                   | 10   | mV    |
|                                       |                          | $I_P = 0\text{ A}$ ; $T_A = -40^\circ\text{C}$ to $25^\circ\text{C}$                       | –    | $\pm 15$            | –    | mV    |
| Total Output Error <sup>2</sup>       | $E_{TOT}$                | $I_P = I_{PR}(\text{max})$ , $T_A = 25^\circ\text{C}$ to $150^\circ\text{C}$               | –2   | –                   | 2    | %     |
|                                       |                          | $I_P = I_{PR}(\text{max})$ , $T_A = -40^\circ\text{C}$ to $25^\circ\text{C}$               | –    | $\pm 3$             | –    | %     |
| <b>Lifetime Drift Characteristics</b> |                          |  |      |                     |      |       |
| Sensitivity Error Lifetime Drift      | $E_{\text{sens\_drift}}$ |  | –    | $\pm 2$             | –    | %     |
| Total Output Error Lifetime Drift     | $E_{\text{tot\_drift}}$  |  | –    | $\pm 2$             | –    | %     |

<sup>1</sup> Offset Voltage does not incorporate any error due to external magnetic fields. See section: Impact of External Magnetic Fields.

<sup>2</sup> Percentage of  $I_P$ , with  $I_P = I_{PR}(\text{max})$ .

### xLLCTR-20AB PERFORMANCE CHARACTERISTICS: $T_A$ Range L, valid at $T_A = -40^\circ\text{C}$ to $150^\circ\text{C}$ , $V_{CC} = 5.0\text{ V}$ , unless otherwise specified

| Characteristic                        | Symbol                   | Test Conditions  | Min. | Typ.                | Max. | Units |
|---------------------------------------|--------------------------|--|------|---------------------|------|-------|
| <b>Nominal Performance</b>            |                          |  |      |                     |      |       |
| Current Sensing Range                 | $I_{PR}$                 |  | –20  | –                   | 20   | A     |
| Sensitivity                           | Sens                     | $I_{PR}(\text{min}) < I_P < I_{PR}(\text{max})$  | –    | 100                 | –    | mV/A  |
| Zero Current Output Voltage           | $V_{IOUT(Q)}$            | Bidirectional; $I_P = 0\text{ A}$  | –    | $V_{CC} \times 0.5$ | –    | V     |
| <b>Accuracy Performance</b>           |                          |  |      |                     |      |       |
| Sensitivity Error                     | $E_{\text{sens}}$        | $T_A = 25^\circ\text{C}$ to $150^\circ\text{C}$ ; measured at $I_P = I_{PR}(\text{max})$   | –1.5 | –                   | 1.5  | %     |
|                                       |                          | $T_A = -40^\circ\text{C}$ to $25^\circ\text{C}$ ; ; measured at $I_P = I_{PR}(\text{max})$ | –    | $\pm 2$             | –    | %     |
| Offset Voltage <sup>1</sup>           | $V_{OE}$                 | $I_P = 0\text{ A}$ ; $T_A = 25^\circ\text{C}$ to $150^\circ\text{C}$                       | –10  | –                   | 10   | mV    |
|                                       |                          | $I_P = 0\text{ A}$ ; $T_A = -40^\circ\text{C}$ to $25^\circ\text{C}$                       | –    | $\pm 15$            | –    | mV    |
| Total Output Error <sup>2</sup>       | $E_{TOT}$                | $I_P = I_{PR}(\text{max})$ , $T_A = 25^\circ\text{C}$ to $150^\circ\text{C}$               | –2   | –                   | 2    | %     |
|                                       |                          | $I_P = I_{PR}(\text{max})$ , $T_A = -40^\circ\text{C}$ to $25^\circ\text{C}$               | –    | $\pm 3$             | –    | %     |
| <b>Lifetime Drift Characteristics</b> |                          |  |      |                     |      |       |
| Sensitivity Error Lifetime Drift      | $E_{\text{sens\_drift}}$ |  | –    | $\pm 2$             | –    | %     |
| Total Output Error Lifetime Drift     | $E_{\text{tot\_drift}}$  |  | –    | $\pm 2$             | –    | %     |

<sup>1</sup> Offset Voltage does not incorporate any error due to external magnetic fields. See section: Impact of External Magnetic Fields.

<sup>2</sup> Percentage of  $I_P$ , with  $I_P = I_{PR}(\text{max})$ .

### xLLCTR-40AU PERFORMANCE CHARACTERISTICS: $T_A$ Range L, valid at $T_A = -40^\circ\text{C}$ to $150^\circ\text{C}$ , $V_{CC} = 5.0\text{ V}$ , unless otherwise specified

| Characteristic                        | Symbol                   | Test Conditions  | Min. | Typ.                | Max. | Units |
|---------------------------------------|--------------------------|--|------|---------------------|------|-------|
| <b>Nominal Performance</b>            |                          |  |      |                     |      |       |
| Current Sensing Range                 | $I_{PR}$                 |  | 0    | –                   | 40   | A     |
| Sensitivity                           | Sens                     | $I_{PR}(\text{min}) < I_P < I_{PR}(\text{max})$  | –    | 100                 | –    | mV/A  |
| Zero Current Output Voltage           | $V_{IOUT(Q)}$            | Unidirectional; $I_P = 0\text{ A}$   | –    | $V_{CC} \times 0.1$ | –    | V     |
| <b>Accuracy Performance</b>           |                          |  |      |                     |      |       |
| Sensitivity Error                     | $E_{\text{sens}}$        | $T_A = 25^\circ\text{C}$ to $150^\circ\text{C}$ ; measured at $I_P = I_{PR}(\text{max})$   | –1.5 | –                   | 1.5  | %     |
|                                       |                          | $T_A = -40^\circ\text{C}$ to $25^\circ\text{C}$ ; ; measured at $I_P = I_{PR}(\text{max})$ | –    | $\pm 2$             | –    | %     |
| Offset Voltage <sup>1</sup>           | $V_{OE}$                 | $I_P = 0\text{ A}$ ; $T_A = 25^\circ\text{C}$ to $150^\circ\text{C}$                       | –10  | –                   | 10   | mV    |
|                                       |                          | $I_P = 0\text{ A}$ ; $T_A = -40^\circ\text{C}$ to $25^\circ\text{C}$                       | –    | $\pm 15$            | –    | mV    |
| Total Output Error <sup>2</sup>       | $E_{TOT}$                | $I_P = I_{PR}(\text{max})$ , $T_A = 25^\circ\text{C}$ to $150^\circ\text{C}$               | –2   | –                   | 2    | %     |
|                                       |                          | $I_P = I_{PR}(\text{max})$ , $T_A = -40^\circ\text{C}$ to $25^\circ\text{C}$               | –    | $\pm 3$             | –    | %     |
| <b>Lifetime Drift Characteristics</b> |                          |  |      |                     |      |       |
| Sensitivity Error Lifetime Drift      | $E_{\text{sens\_drift}}$ |  | –    | $\pm 2$             | –    | %     |
| Total Output Error Lifetime Drift     | $E_{\text{tot\_drift}}$  |  | –    | $\pm 2$             | –    | %     |

<sup>1</sup> Offset Voltage does not incorporate any error due to external magnetic fields. See section: Impact of External Magnetic Fields.

<sup>2</sup> Percentage of  $I_P$ , with  $I_P = I_{PR}(\text{max})$ .

### xLLCTR-40AB PERFORMANCE CHARACTERISTICS: $T_A$ Range L, valid at $T_A = -40^\circ\text{C}$ to $150^\circ\text{C}$ , $V_{CC} = 5.0\text{ V}$ , unless otherwise specified

| Characteristic                        | Symbol                   | Test Conditions  | Min. | Typ.                | Max. | Units |
|---------------------------------------|--------------------------|--|------|---------------------|------|-------|
| <b>Nominal Performance</b>            |                          |  |      |                     |      |       |
| Current Sensing Range                 | $I_{PR}$                 |  | –40  | –                   | 40   | A     |
| Sensitivity                           | Sens                     | $I_{PR}(\text{min}) < I_P < I_{PR}(\text{max})$  | –    | 50                  | –    | mV/A  |
| Zero Current Output Voltage           | $V_{IOUT(Q)}$            | Bidirectional; $I_P = 0\text{ A}$  | –    | $V_{CC} \times 0.5$ | –    | V     |
| <b>Accuracy Performance</b>           |                          |  |      |                     |      |       |
| Sensitivity Error                     | $E_{\text{sens}}$        | $T_A = 25^\circ\text{C}$ to $150^\circ\text{C}$ ; measured at $I_P = I_{PR}(\text{max})$   | –1.5 | –                   | 1.5  | %     |
|                                       |                          | $T_A = -40^\circ\text{C}$ to $25^\circ\text{C}$ ; ; measured at $I_P = I_{PR}(\text{max})$ | –    | $\pm 2$             | –    | %     |
| Offset Voltage <sup>1</sup>           | $V_{OE}$                 | $I_P = 0\text{ A}$ ; $T_A = 25^\circ\text{C}$ to $150^\circ\text{C}$                       | –10  | –                   | 10   | mV    |
|                                       |                          | $I_P = 0\text{ A}$ ; $T_A = -40^\circ\text{C}$ to $25^\circ\text{C}$                       | –    | $\pm 15$            | –    | mV    |
| Total Output Error <sup>2</sup>       | $E_{TOT}$                | $I_P = I_{PR}(\text{max})$ , $T_A = 25^\circ\text{C}$ to $150^\circ\text{C}$               | –2   | –                   | 2    | %     |
|                                       |                          | $I_P = I_{PR}(\text{max})$ , $T_A = -40^\circ\text{C}$ to $25^\circ\text{C}$               | –    | $\pm 3$             | –    | %     |
| <b>Lifetime Drift Characteristics</b> |                          |  |      |                     |      |       |
| Sensitivity Error Lifetime Drift      | $E_{\text{sens\_drift}}$ |  | –    | $\pm 2$             | –    | %     |
| Total Output Error Lifetime Drift     | $E_{\text{tot\_drift}}$  |  | –    | $\pm 2$             | –    | %     |

<sup>1</sup> Offset Voltage does not incorporate any error due to external magnetic fields. See section: Impact of External Magnetic Fields.

<sup>2</sup> Percentage of  $I_P$ , with  $I_P = I_{PR}(\text{max})$ .

### CHARACTERISTIC PERFORMANCE

#### xLLCTR-5AB Key Parameters

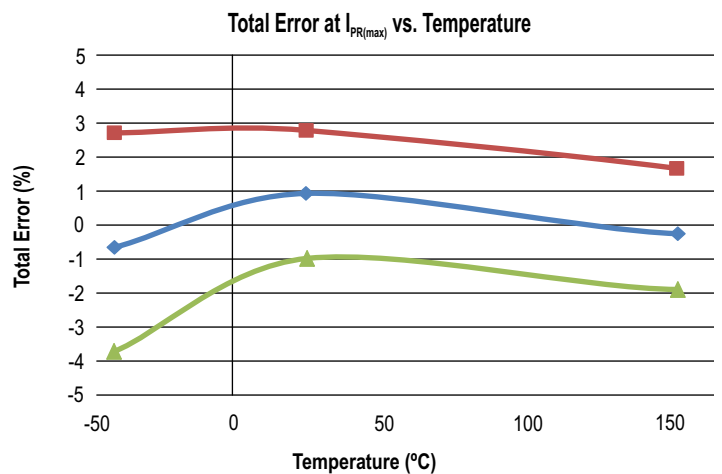
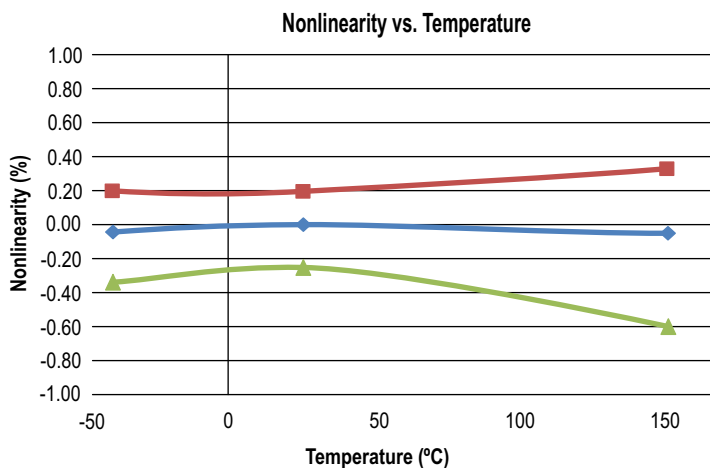
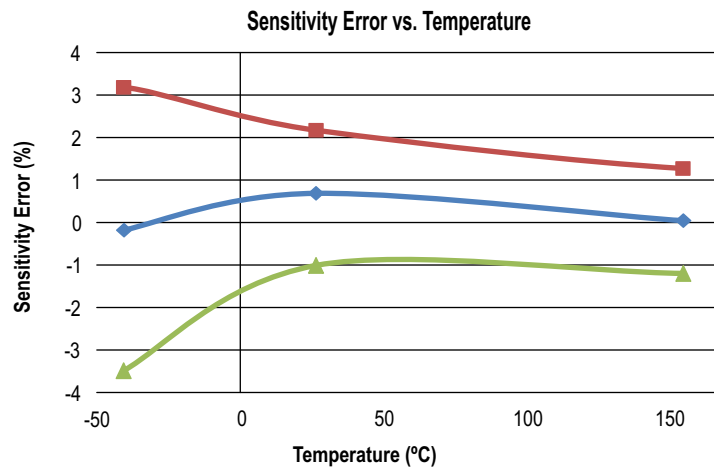
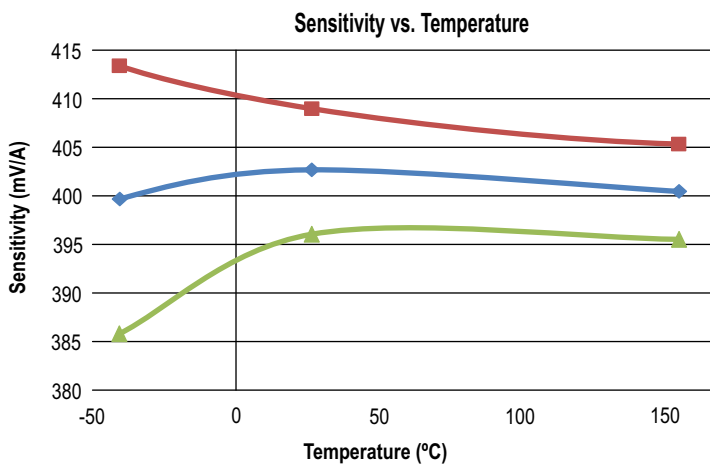
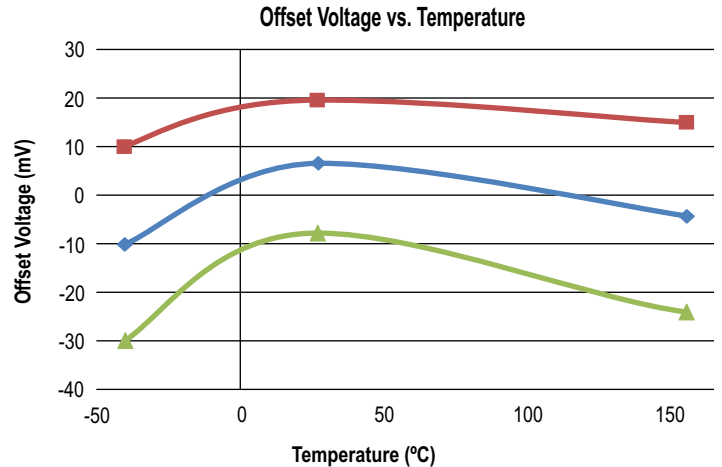
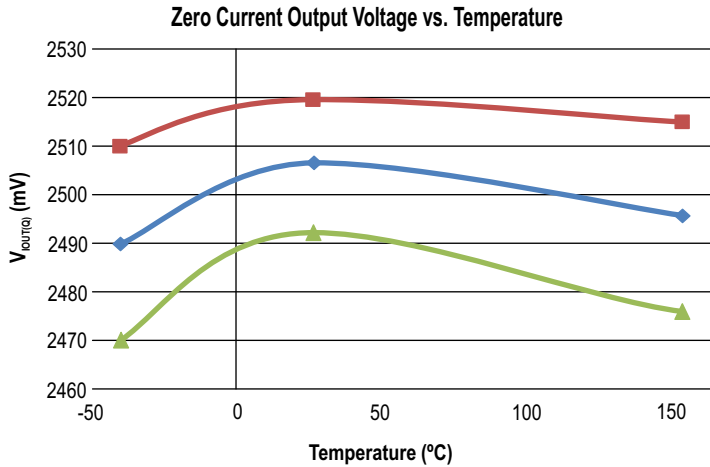

■ +3 Sigma     
 ◆ Average     
 ▲ -3 Sigma

### xLLCTR-10AB Key Parameters

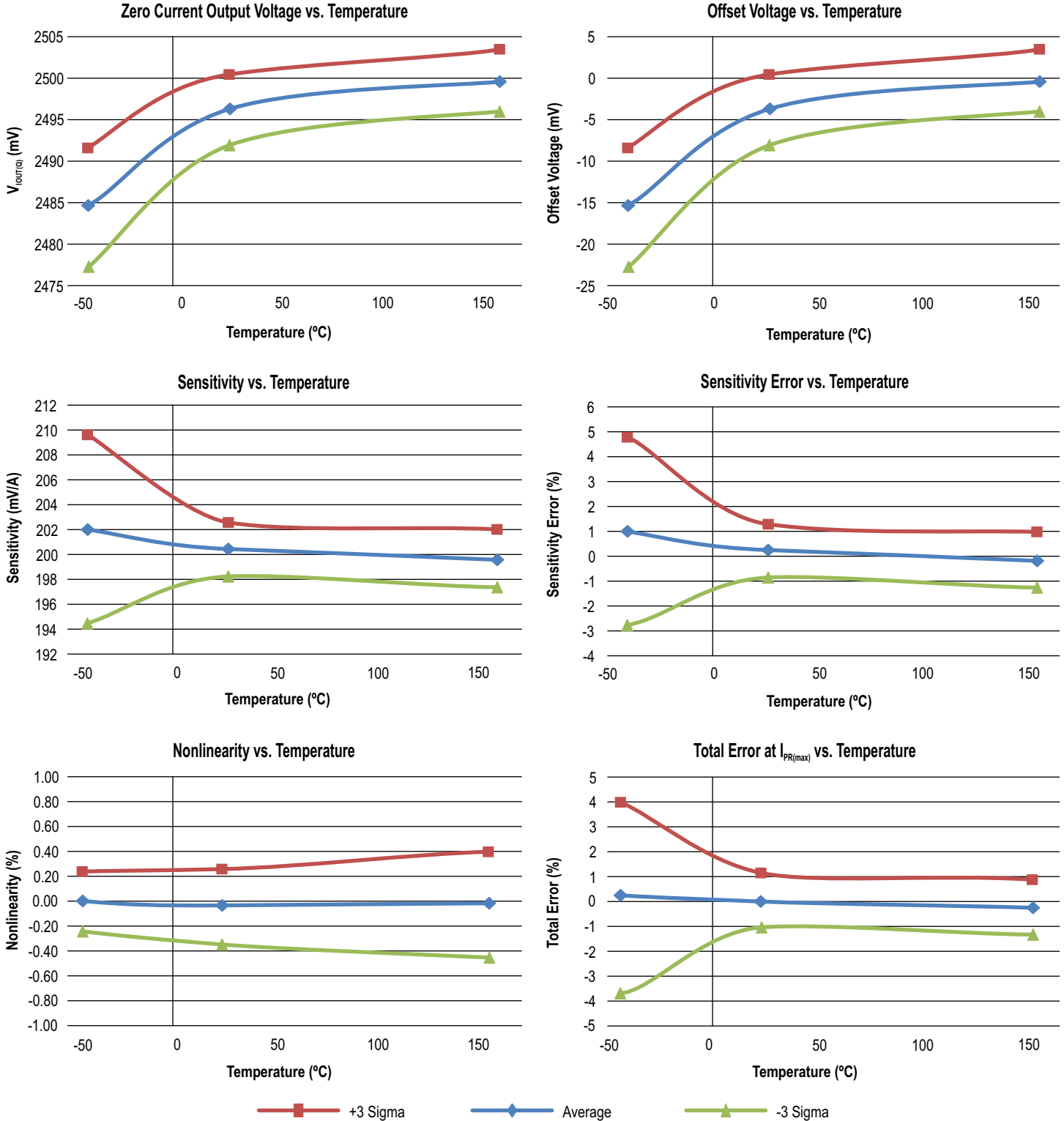

### xLLCTR-10AU Key Parameters

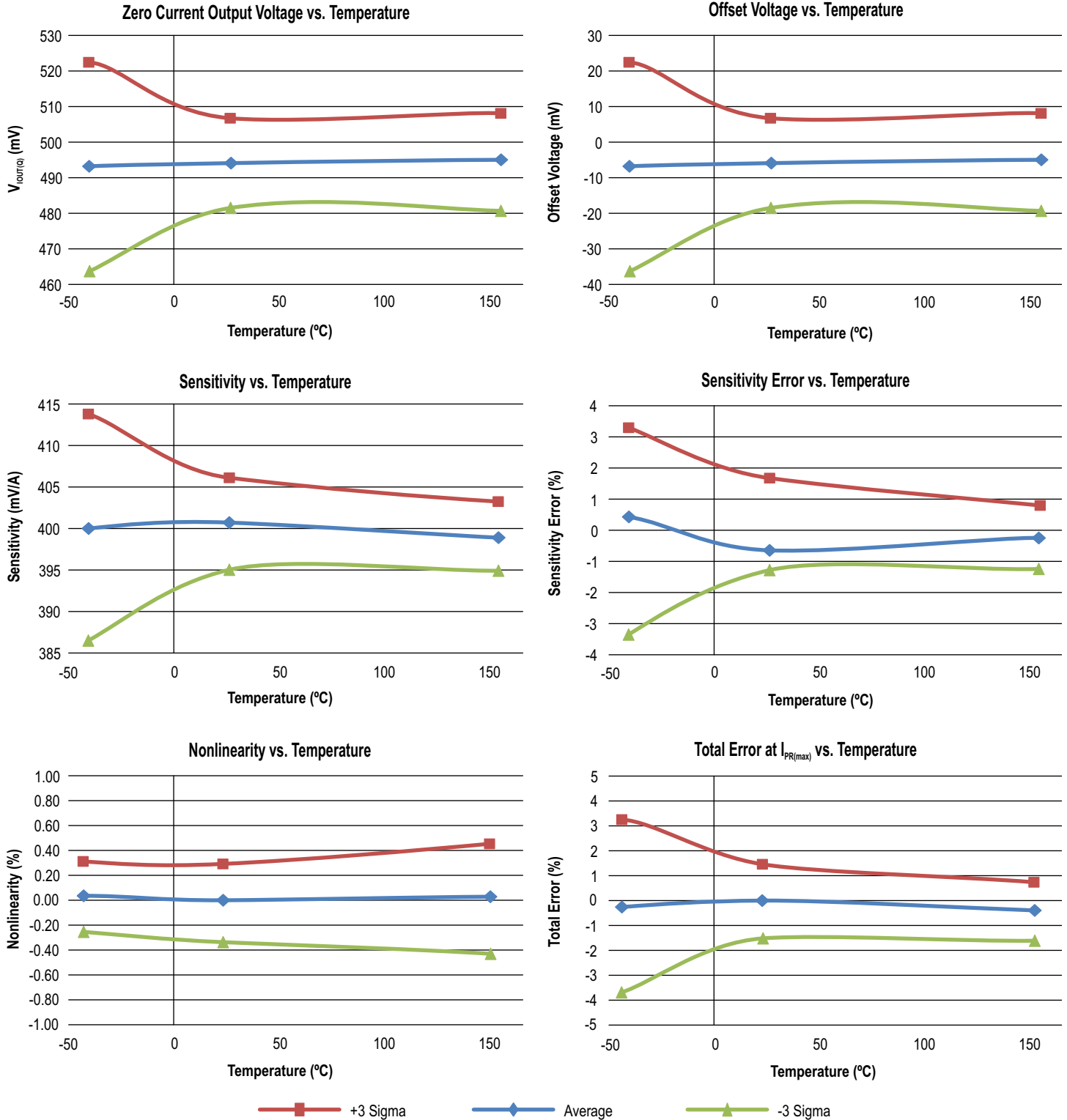

### xLLCTR-20AB Key Parameters

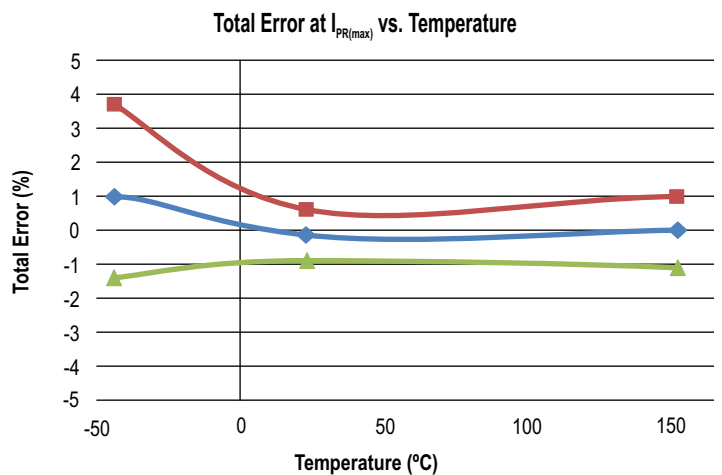
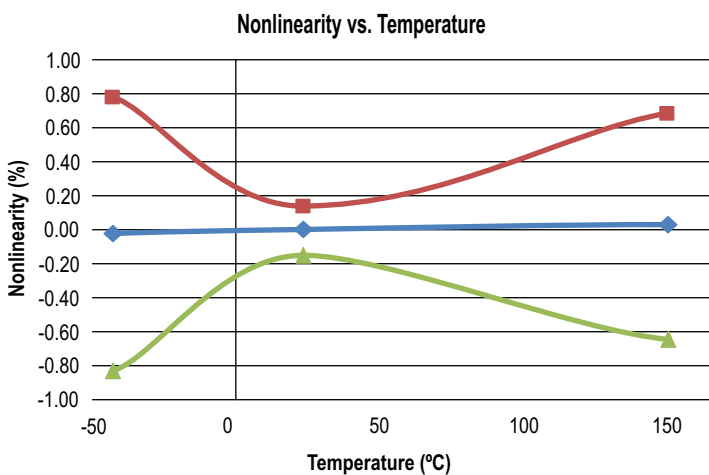
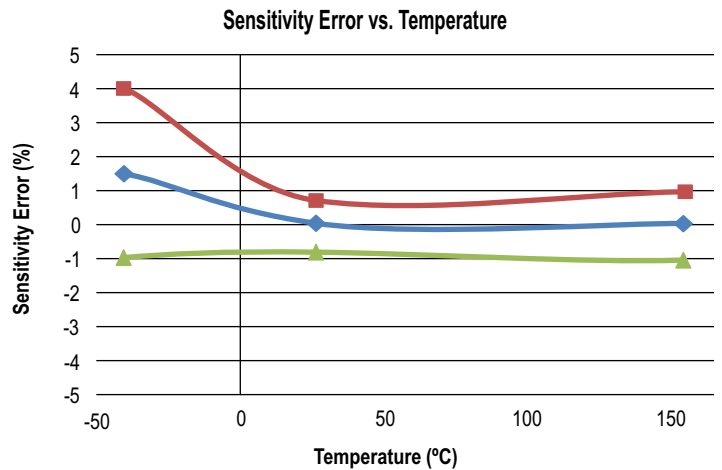
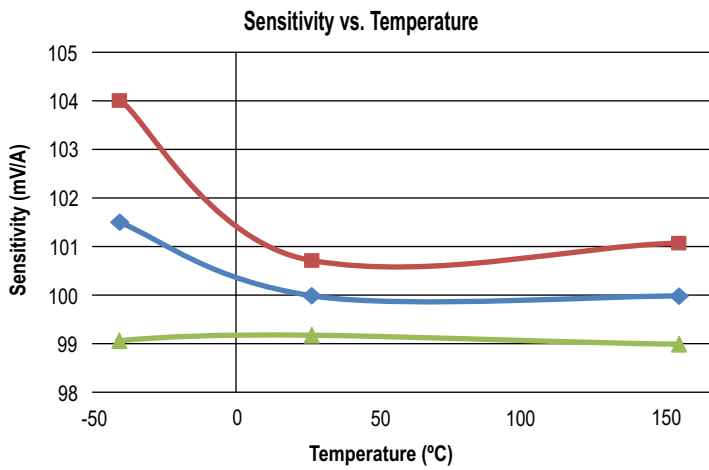
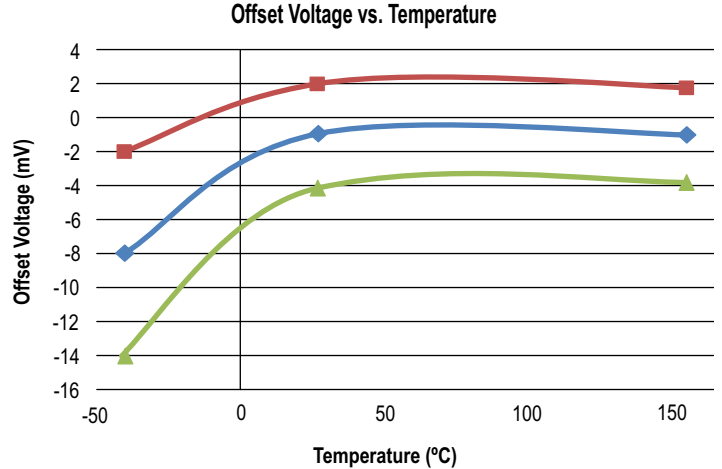
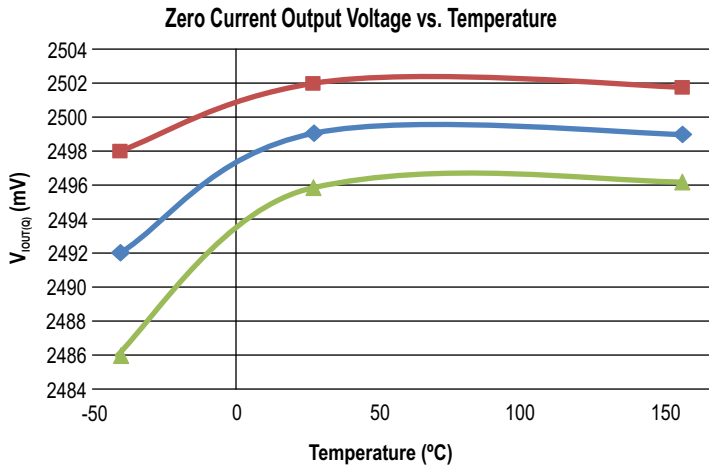

—■— +3 Sigma     
 —◆— Average     
 —▲— -3 Sigma

### xLLCTR-20AU Key Parameters

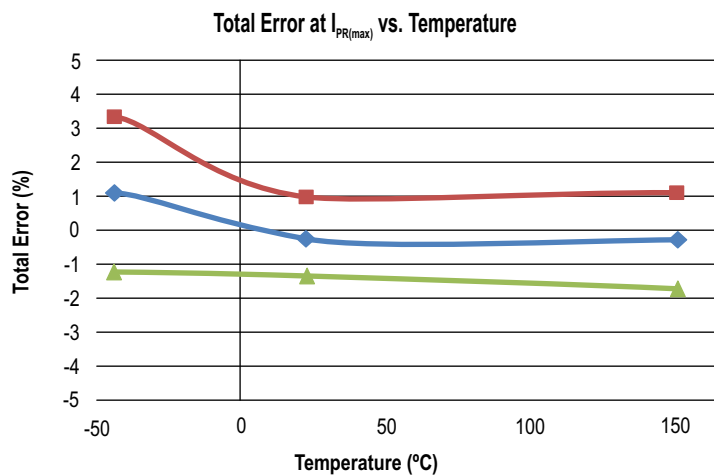
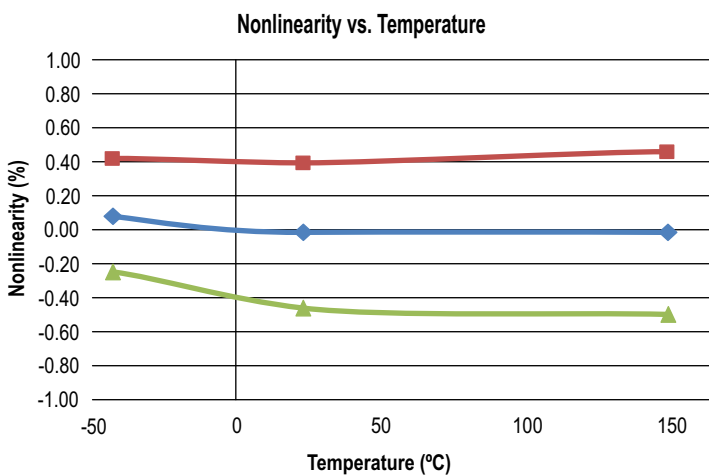
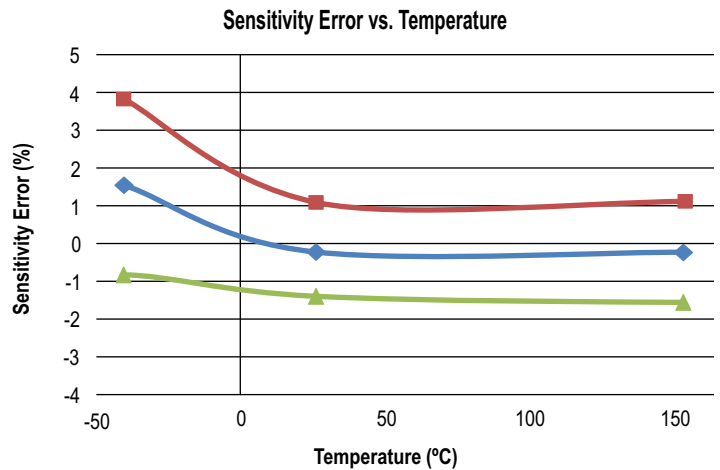
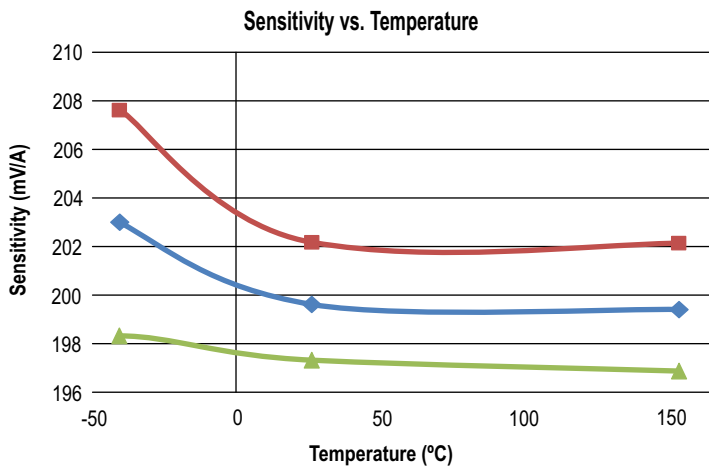
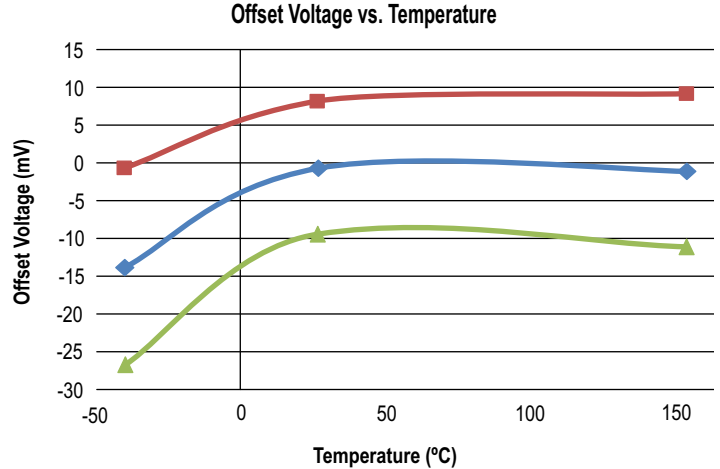
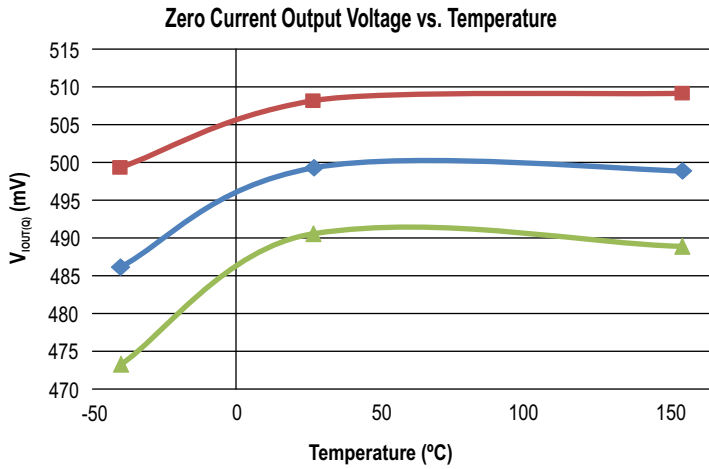

■ +3 Sigma     
 ◆ Average     
 ▲ -3 Sigma

### xLLCTR-40AB Key Parameters

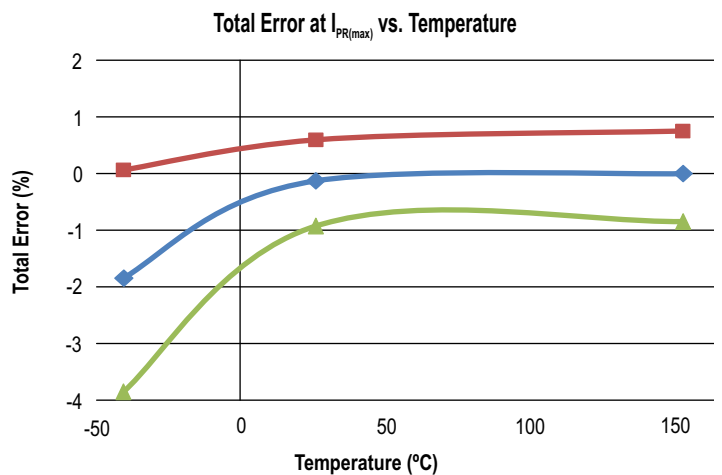
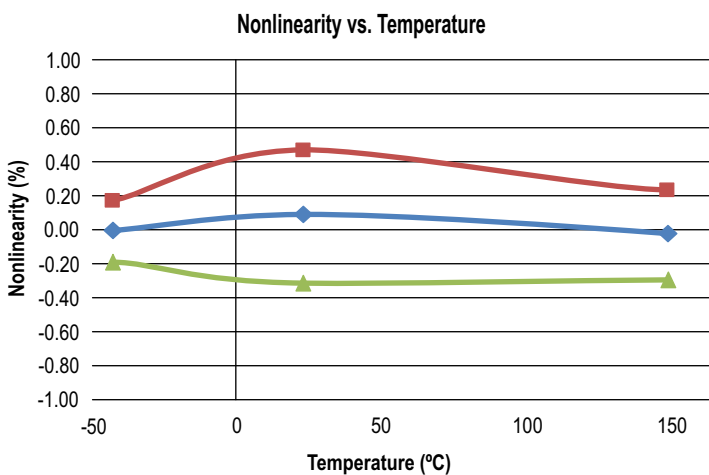
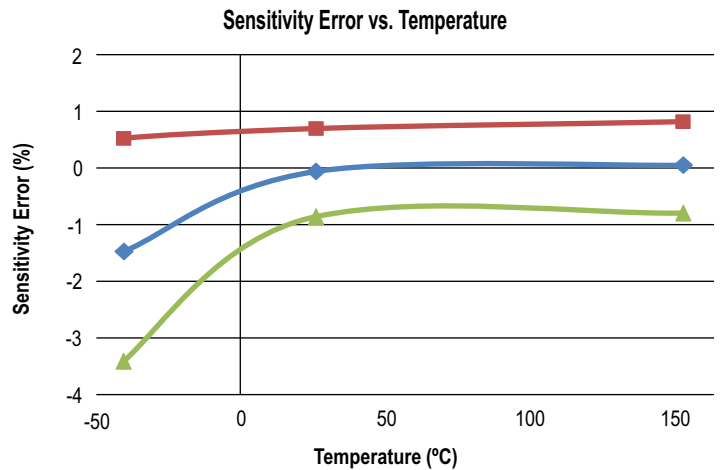
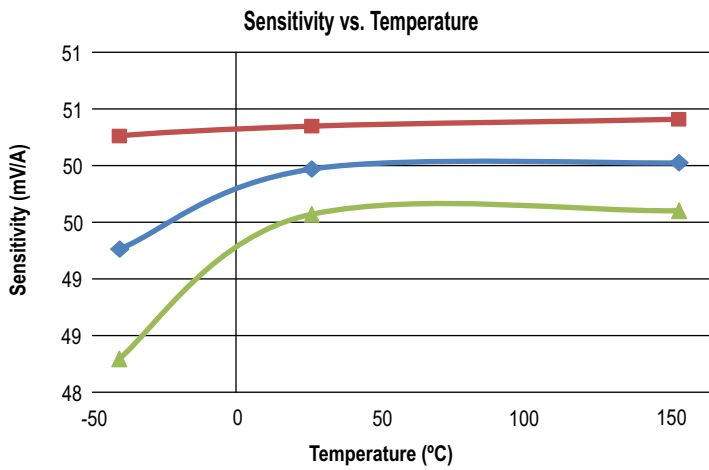
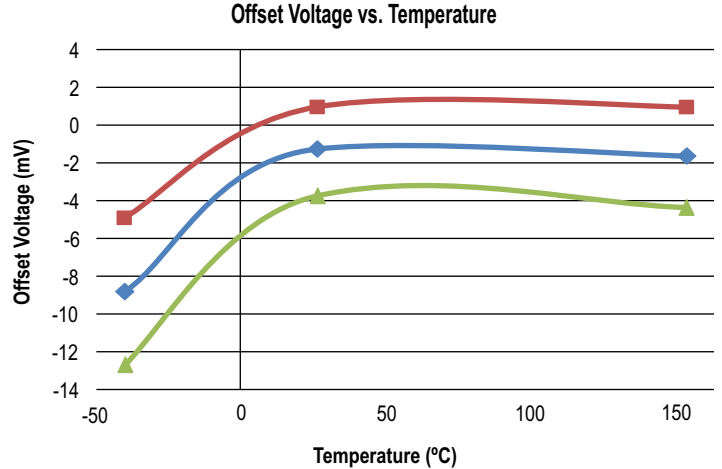
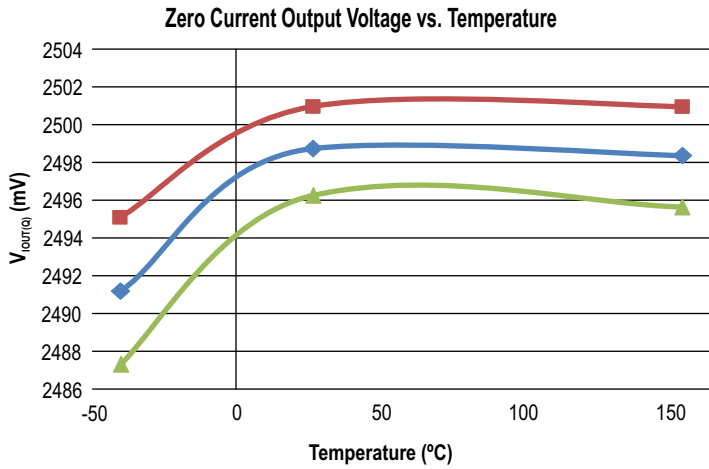

■ +3 Sigma     
 ◆ Average     
 ▲ -3 Sigma



### xLLCTR-40AU Key Parameters

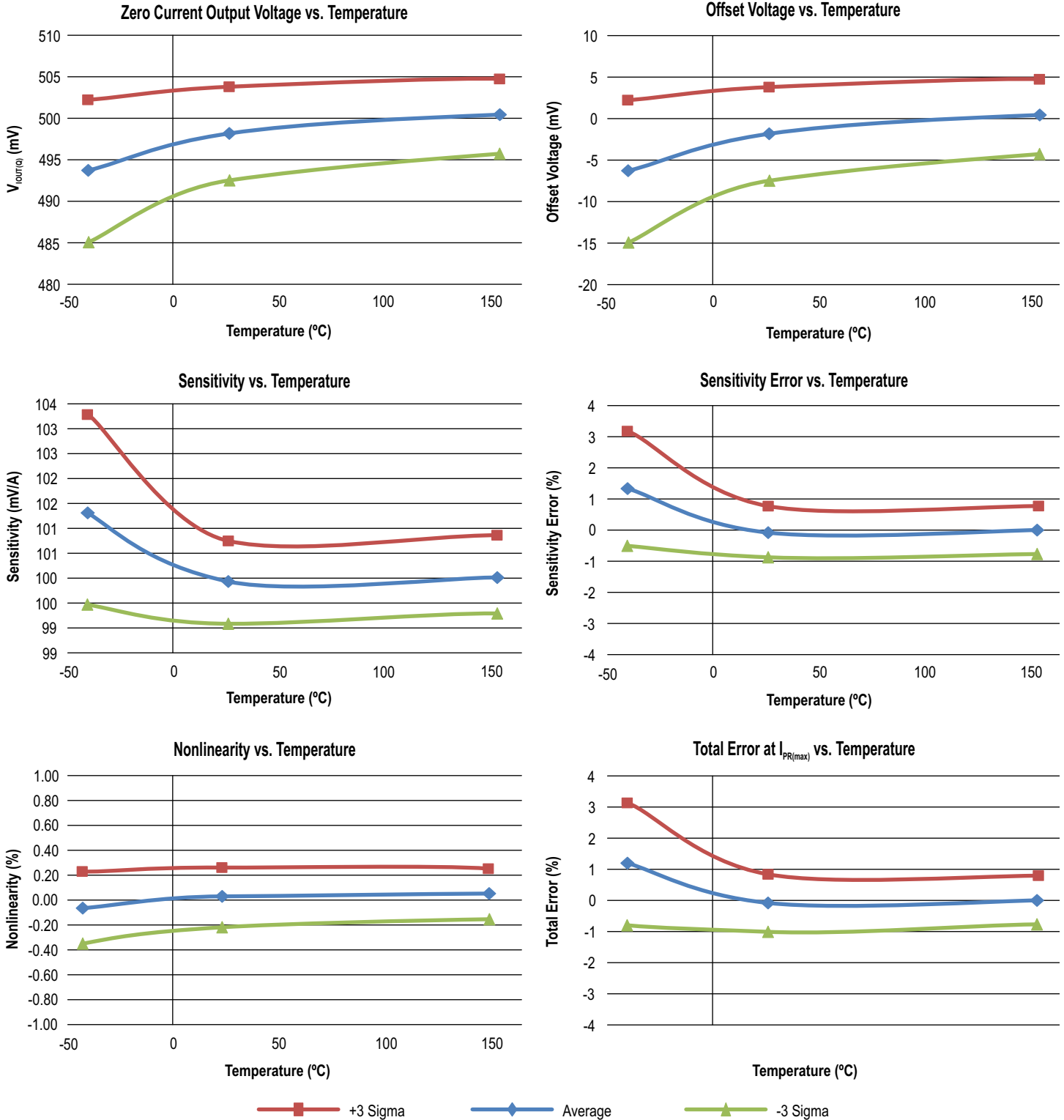

## DEFINITIONS OF ACCURACY CHARACTERISTICS

### Sensitivity (Sens)

The change in sensor IC output in response to a 1A change through the primary conductor. The sensitivity is the product of the magnetic circuit sensitivity (G/A) (1 G = 0.1 mT) and the linear IC amplifier gain (mV/G). The linear IC amplifier gain is programmed at the factory to optimize the sensitivity (mV/A) for the full-scale current of the device.

### Nonlinearity ( $E_{LIN}$ )

The nonlinearity is a measure of how linear the output of the sensor IC is over the full current measurement range. The nonlinearity is calculated as:

$$E_{LIN} = \left\{ 1 - \left[ \frac{V_{IOUT}(I_{PR(max)}) - V_{IOUT(Q)}}{2 \times V_{IOUT}(I_{PR(max)/2}) - V_{IOUT(Q)}} \right] \right\} \times 100 (\%)$$

where  $V_{IOUT}(I_{PR(max)})$  is the output of the sensor IC with the maximum measurement current flowing through it and  $V_{IOUT}(I_{PR(max)/2})$  is the output of the sensor IC with half of the maximum measurement current flowing through it.

### Zero Current Output Voltage ( $V_{IOUT(Q)}$ )

The output of the sensor when the primary current is zero. For a unipolar supply voltage, it nominally remains at  $0.5 \times V_{CC}$  for a bidirectional device and  $0.1 \times V_{CC}$  for a unidirectional device. For example, in the case of a bidirectional output device,  $V_{CC} = 5.0 \text{ V}$  translates into  $V_{IOUT(Q)} = 2.5 \text{ V}$ . Variation in  $V_{IOUT(Q)}$  can be attributed to the resolution of the Allegro linear IC quiescent voltage trim and thermal drift.

### Offset Voltage ( $V_{OE}$ )

The deviation of the device output from its ideal quiescent value of  $0.5 \times V_{CC}$  (bidirectional) or  $0.1 \times V_{CC}$  (unidirectional) due to nonmagnetic causes. To convert this voltage to amperes, divide by the device sensitivity, Sens.

### Total Output Error ( $E_{TOT}$ )

The difference between the current measurement from the sensor IC and the actual current ( $I_P$ ), relative to the actual current. This is equivalent to the difference between the ideal output voltage and the actual output voltage, divided by the ideal sensitivity, relative to the current flowing through the primary conduction path:

$$E_{TOT}(I_P) = \frac{V_{IOUT\_ideal}(I_P) - V_{IOUT}(I_P)}{\text{Sens}_{ideal}(I_P) \times I_P} \times 100 (\%)$$

The Total Output Error incorporates all sources of error and is a function of  $I_P$ . At relatively high currents,  $E_{TOT}$  will be mostly

due to sensitivity error, and at relatively low currents,  $E_{TOT}$  will be mostly due to Offset Voltage ( $V_{OE}$ ). In fact, at  $I_P = 0$ ,  $E_{TOT}$  approaches infinity due to the offset. This is illustrated in figures 1 and 2. Figure 1 shows a distribution of output voltages versus  $I_P$  at 25°C and across temperature. Figure 2 shows the corresponding  $E_{TOT}$  versus  $I_P$ .

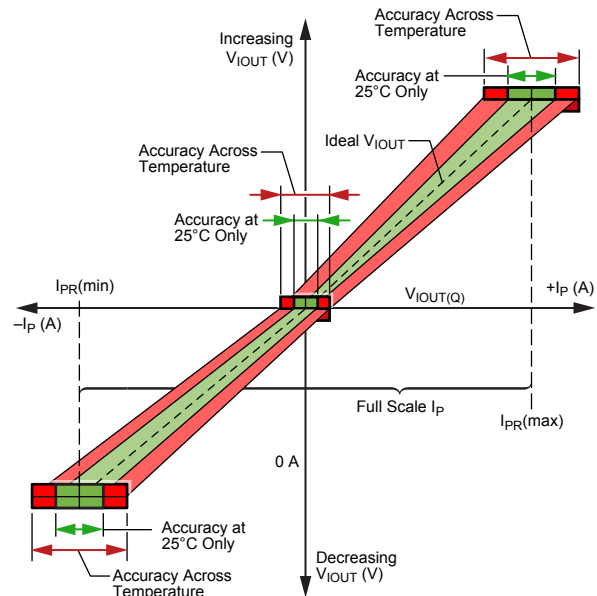

Figure 1. Output voltage versus sensed current

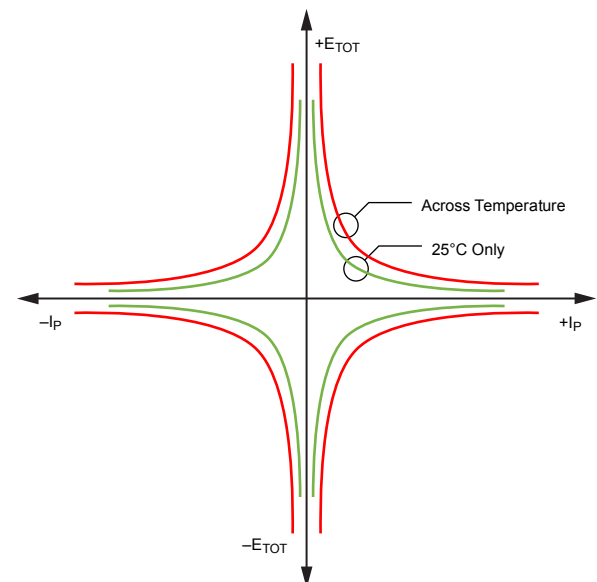

Figure 2. Total Output Error versus sensed current

**APPLICATION INFORMATION****Impact of External Magnetic Fields**

The ACS723 works by sensing the magnetic field created by the current flowing through the package. However, the sensor cannot differentiate between fields created by the current flow and external magnetic fields. This means that external magnetic fields can cause errors in the output of the sensor. Magnetic fields which are perpendicular to the surface of the package affect the output of the sensor, as it only senses fields in that one plane. The error in Amperes can be quantified as:

$$Error(B) = \frac{B}{C_F}$$

where B is the strength of the external field perpendicular to the

surface of the package in Gauss, and  $C_F$  is the coupling factor in G/A. Then, multiplying by the sensitivity of the part, Sens, gives the error in mV.

For example, an external field of 1 Gauss will result in around 0.1 A of error. If the ACS723LLCTR-10AB, which has a nominal sensitivity of 200 mV/A, is being used, that equates to 20 mV of error on the output of the sensor.

| External Field (Gauss) | Error (A) | Error (mV) |      |      |      |
|------------------------|-----------|------------|------|------|------|
|                        |           | 5AB        | 10AB | 20AB | 40AB |
| 0.5                    | 0.05      | 20         | 10   | 5    | 2.5  |
| 1                      | 0.1       | 40         | 20   | 10   | 5    |
| 2                      | 0.2       | 80         | 40   | 20   | 10   |

## DEFINITIONS OF DYNAMIC RESPONSE CHARACTERISTICS

### Power-On Time ( $t_{PO}$ )

When the supply is ramped to its operating voltage, the device requires a finite time to power its internal components before responding to an input magnetic field.

Power-On Time,  $t_{PO}$ , is defined as the time it takes for the output voltage to settle within  $\pm 10\%$  of its steady state value under an applied magnetic field, after the power supply has reached its minimum specified operating voltage,  $V_{CC(min)}$ , as shown in the chart at right.

### Rise Time ( $t_r$ )

The time interval between a) when the sensor IC reaches 10% of its full scale value, and b) when it reaches 90% of its full scale value. The rise time to a step response is used to derive the bandwidth of the current sensor IC, in which  $f(-3 \text{ dB}) = 0.35/t_r$ . Both  $t_r$  and  $t_{RESPONSE}$  are detrimentally affected by eddy current losses observed in the conductive IC ground plane.

### Propagation Delay ( $t_{pd}$ )

The propagation delay is measured as the time interval a) when the primary current signal reaches 20% of its final value, and b) when the device reaches 20% of its output corresponding to the applied current.

### Response Time ( $t_{RESPONSE}$ )

The time interval between a) when the primary current signal reaches 90% of its final value, and b) when the device reaches 90% of its output corresponding to the applied current.

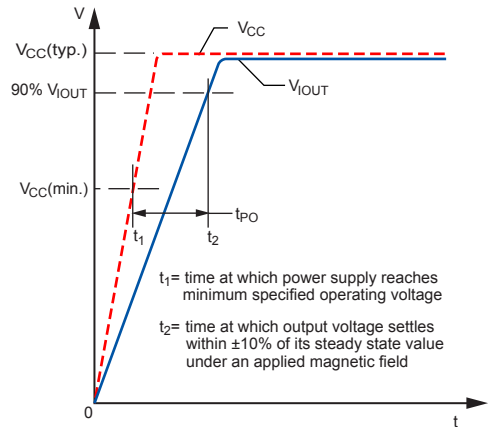

Figure 3: Power-On Time ( $t_{PO}$ )

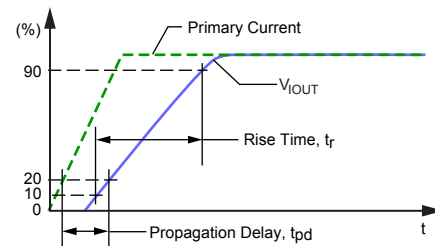

Figure 4: Rise Time ( $t_r$ ) and Propagation Delay ( $t_{pd}$ )

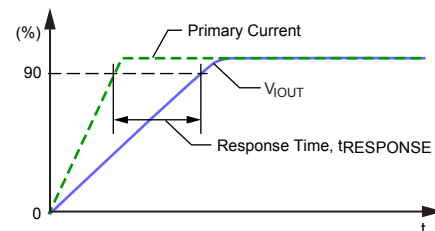

Figure 5: Response Time ( $t_{RESPONSE}$ )

## Package Outline Drawing

### For Reference Only – Not for Tooling Use

(Reference MS-012AA)

Dimensions in millimeters – NOT TO SCALE

Dimensions exclusive of mold flash, gate burrs, and dambar protrusions  
Exact case and lead configuration at supplier discretion within limits shown

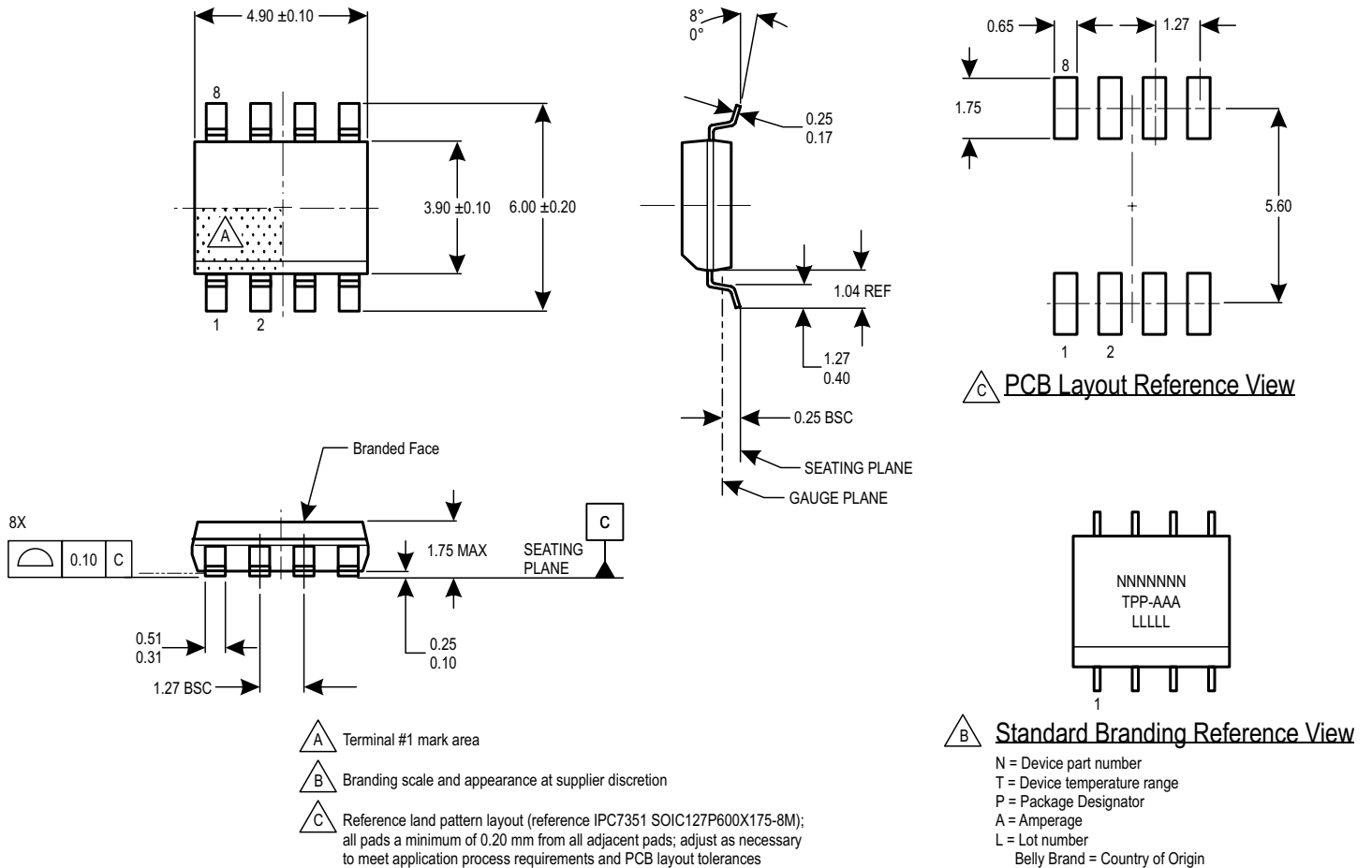

Figure 6: Package LC, 8-pin SOICN

**Revision History**

| Revision | Revision Date    | Description of Revision   |
|----------|------------------|---|
| –        | June 10, 2014    | Initial release.  |
| 1        | October 29, 2014 | Added Magnetic Coupling Factor characteristic and Error Due to External Magnetic Fields section |
| 2        | April 30, 2015   | Added Characteristic Performance graphs   |

Copyright ©2011-2015, Allegro MicroSystems, LLC

Allegro MicroSystems, LLC reserves the right to make, from time to time, such departures from the detail specifications as may be required to permit improvements in the performance, reliability, or manufacturability of its products. Before placing an order, the user is cautioned to verify that the information being relied upon is current.

Allegro's products are not to be used in any devices or systems, including but not limited to life support devices or systems, in which a failure of Allegro's product can reasonably be expected to cause bodily harm.

The information included herein is believed to be accurate and reliable. However, Allegro MicroSystems, LLC assumes no responsibility for its use; nor for any infringement of patents or other rights of third parties which may result from its use.

*For the latest version of this document, visit our website:*

[www.allegromicro.com](http://www.allegromicro.com)

