

IX4340

5-Ampere, Dual Low-Side MOSFET Driver

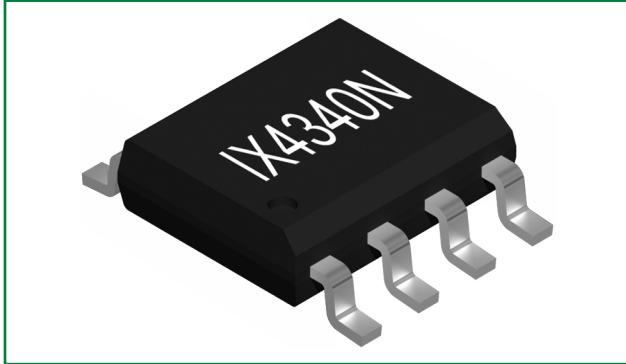

Features

- Two Independent Drivers, Each Capable of Sourcing and Sinking 5A
- CMOS and TTL Compatible Inputs
- Independent Enable for Each Driver
- 5V to 18V Supply Voltage Range
- -40°C to +125°C Extended Operating Temperature Range
- ±4kV ESD Rating (Human Body Model)
- Thermally Enhanced 8-pin SOIC and MSOP Packages, and Standard 8-pin SOIC Package
- Under Voltage Lockout Circuitry
- Fast Propagation Delays (16ns typical)
- Fast Rise and Fall Times (7ns typical)

Applications

- Switch-Mode Power Supplies
- DC-DC Converters
- Motor Controllers
- Power Inverters

IX4340 Functional Block Diagram

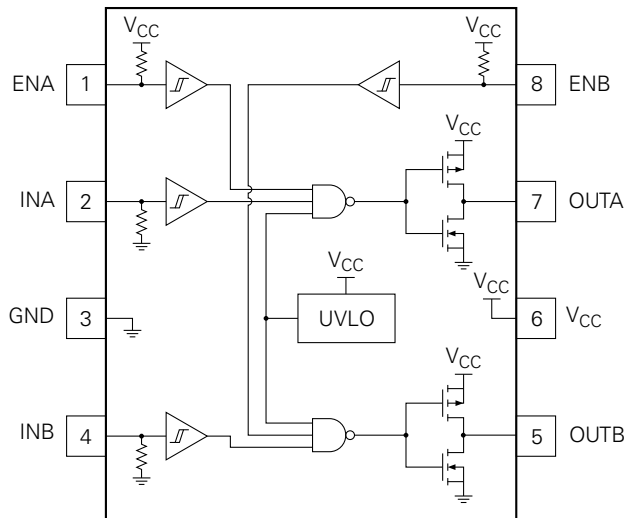

Description



The IX4340 is a dual, high current, low-side gate driver. Each of the two outputs is capable of sourcing and sinking 5A of peak current, and has a maximum voltage rating of 20V. The two outputs can be paralleled for higher current applications. Fast propagation delay times (16ns typical) and fast rise and fall times (7ns) make the IX4340 well suited for high frequency applications.

The inputs are TTL and CMOS logic compatible, and there is an independent Enable function for each output. Under voltage lockout circuitry (UVLO) prevents the high side source driver from conducting until there is sufficient supply voltage. The outputs are held low if the logic inputs are floating.

The IX4340 is available in a standard 8-pin SOIC and thermally enhanced 8-pin SOIC and MSOP packages.

Ordering Information

Part #	Description
IX4340N	8-Pin SOIC (100/Tube)
IX4340NTR	8-Pin SOIC (4000/Reel)
IX4340NE	8-Pin SOIC w/ Exposed Thermal Pad (100/Tube)
IX4340NETR	8-Pin SOIC w/ Exposed Thermal Pad (4000/Reel)
IX4340UE	8-Pin MSOP w/ Exposed Thermal Pad (80/Tube)
IX4340UETR	8-Pin MSOP w/ Exposed Thermal Pad (5000/Reel)

1 Specifications	3
1.1 Pin Configuration	3
1.2 Logic Table	3
1.3 Pin Definitions	3
1.4 Absolute Maximum Ratings	3
1.5 Electrical Characteristics	4
1.6 Switching Characteristics	5
1.7 Thermal Characteristics	5
2 Performance Data	6
3 Manufacturing Information	8
3.1 Moisture Sensitivity	8
3.2 ESD Sensitivity	8
3.3 Soldering Profile	8
3.4 Board Wash	8
3.5 Mechanical Dimensions	9
3.5.1 IX4340NE Package Dimensions	9
3.5.2 IX4340N Package Dimensions	9
3.5.3 IX4340NTR & IX4340NETR Tape & Reel Dimensions	10
3.5.4 IX4340UE Package Dimensions	10
3.5.5 IX4340UETR Tape & Reel Dimensions	11

1 Specifications

1.1 Pin Configuration

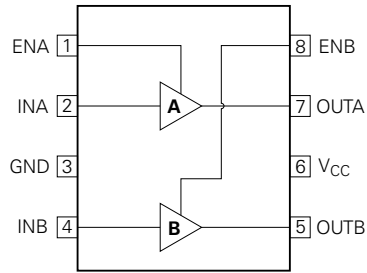

1.2 Logic Table

IN _x	EN _x	V _{CC}	OUT _x
1	1	V _{CC} > UVLO _{ON}	1
0	1	V _{CC} > UVLO _{ON}	0
x	0	V _{CC} > UVLO _{ON}	0
x	x	V _{CC} < UVLO _{ON}	0

1.3 Pin Definitions

Pin	Name	Description
1	ENA	Enable input for Channel A. A logic high (or floating) enables Channel A (the state of OUTA is determined by INA). A logic low disables OUTA (OUTA held low regardless of INA).
2	INA	Channel A logic input. Internally pulled to GND.
3	GND	Ground. Common ground reference for the device.
4	INB	Channel B logic input. Internally pulled to GND.
5	OUTB	Channel B output, capable of sourcing and sinking 5A.
6	V _{CC}	Supply voltage.
7	OUTA	Channel A output, capable of sourcing and sinking 5A.
8	ENB	Enable input for Channel B. A logic high (or floating) enables Channel B (the state of OUTB is determined by INB). A logic low disables OUTB (OUTB held low regardless of INB).

The thermal pad on the bottom of the thermally enhanced devices, IX4340NE and IX4340UE, may be connected to GND or left floating; it must not be connected to any other net. The thermal pad is not intended to carry current.

1.4 Absolute Maximum Ratings

Parameter	Symbol	Value		Units
		Minimum	Maximum	
Supply Voltage	V _{CC}	-0.3	20	V
Input Voltage	V _{IN}	-0.3	20	
Output Current	I _{OUT}	-	±5	A
ESD Rating (Human Body Model)	V _{ESD}	-4000	+4000	V
Junction Temperature	T _J	-55	+150	°C
Storage Temperature	T _{STG}	-65	+150	

Absolute maximum electrical ratings are at T_A = 25°C.

Absolute maximum ratings are stress ratings. Stresses in excess of these ratings can cause permanent damage to the device. Functional operation of the device at conditions beyond those indicated in the operational sections of this data sheet is not implied.

1.5 Electrical Characteristics

$V_{CC} = 12V$, $T_J = -40^{\circ}C$ to $+125^{\circ}C$, unless otherwise noted.

Parameter	Conditions	Symbol	Value			Units
			Minimum	Typical	Maximum	
Supply						
Supply current	OUTA and OUTB open	I_{CC}	-	1.4	2.5	mA
Under Voltage Lockout (UVLO)						
UVLO Rising Threshold	V_{CC} Rising	$UVLO_{ON}$	3.5	3.85	4.2	V
UVLO Falling Threshold	V_{CC} Falling	$UVLO_{OFF}$	3.1	3.3	3.5	
UVLO Threshold Hysteresis	-	$UVLO_{HYS}$	0.2	0.5	0.8	
Logic Inputs (INA, INB, ENA, ENB)						
Input Low Voltage	-	V_{IL}	-	-	0.8	V
Input High Voltage	-	V_{IH}	2.5	-	-	
Output Drivers (OUTA, OUTB)						
Output Pull-Up Resistance	$I_{OUT} = -100mA$, $T_J = 25^{\circ}C$	R_{OH}	-	1	1.5	Ω
	$I_{OUT} = -100mA$		-	1.3	1.8	
Output Pull-Down Resistance	$I_{OUT} = 100mA$, $T_J = 25^{\circ}C$	R_{OL}	-	0.6	1.1	
	$I_{OUT} = 100mA$		-	0.8	1.4	

1.6 Switching Characteristics

Unless otherwise noted, $V_{CC} = 12V$, $T_J = -40^{\circ}C$ to $+125^{\circ}C$.

Parameter	Conditions	Symbol	Value			Units
			Minimum	Typical	Maximum	
Propagation delay	$C_{LOAD} = 1.8nF$					ns
		t_{DLH}	5	16	30	
	t_{DHL}	5	16	30		
Matching	-	-	-5	-	5	
Rise Time	$C_{LOAD} = 1.8nF$	t_R	-	7	15	
Fall Time	$C_{LOAD} = 1.8nF$	t_F	-	7	15	

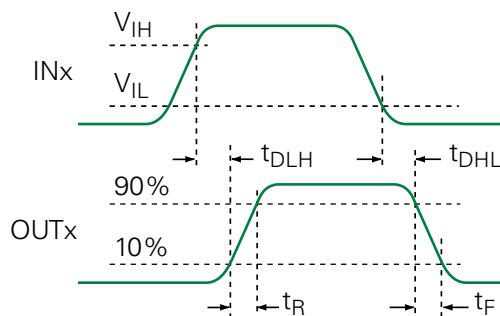

1.7 Thermal Characteristics

Parameter	Symbol	Rating	Units
IX4340N Thermal Impedance, Junction-to-Ambient	θ_{JA}	120	$^{\circ}C/W$
IX4340NE Thermal Impedance, Junction-to-Ambient	θ_{JA}	85	
IX4340NE Thermal Impedance, Junction-to-Case	θ_{JC}	10	
IX4340UE Thermal Impedance, Junction-to-Ambient	θ_{JA}	40	
IX4340UE Thermal Impedance, Junction-to-Case	θ_{JC}	10	

2 Performance Data

Unless otherwise noted, data presented in these graphs is typical of device operation at $T_A = 25^\circ\text{C}$.

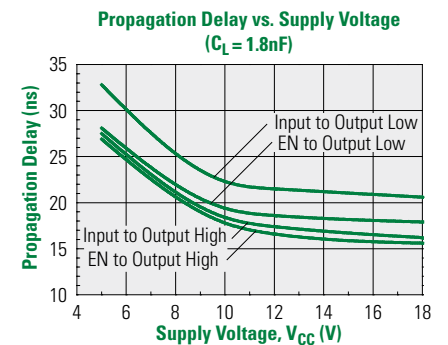
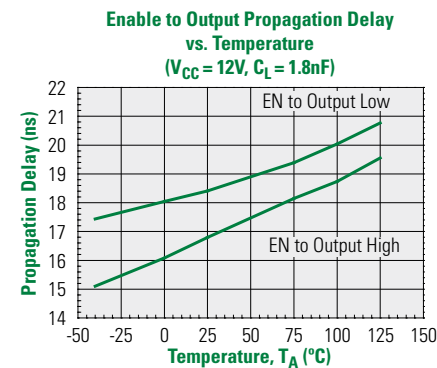
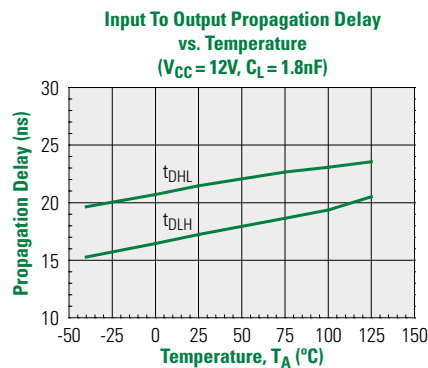
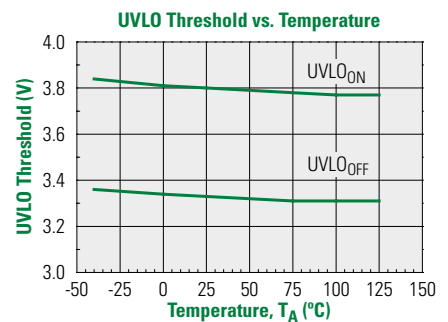
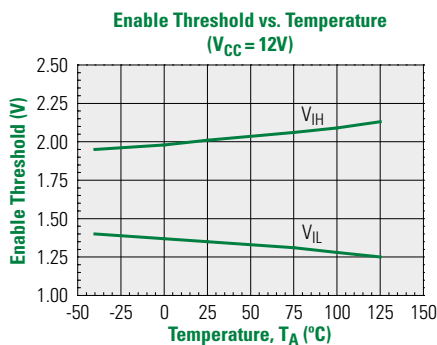
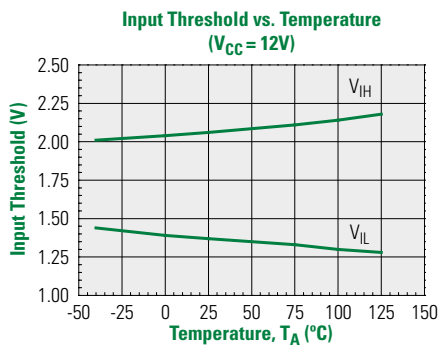
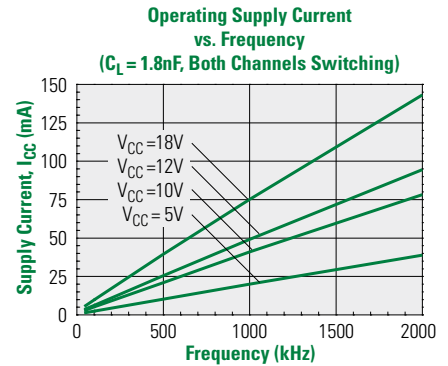
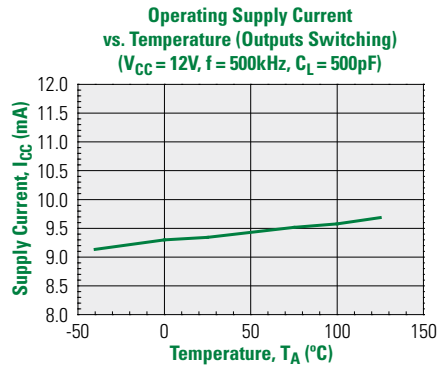
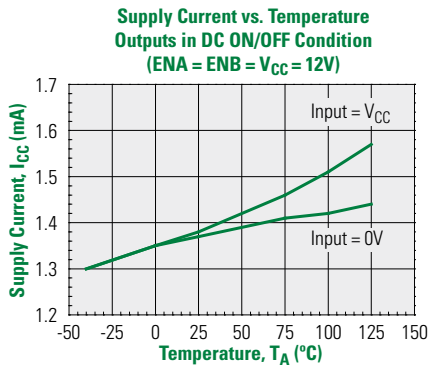

Rise Time vs. Supply Voltage
($C_L = 1.8\text{nF}$)

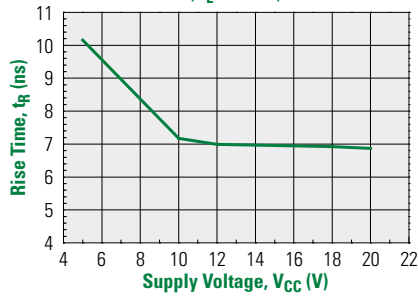

Fall Time vs. Supply Voltage
($C_L = 1.8\text{nF}$)

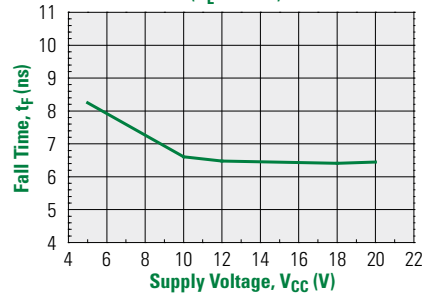

Output Pull-Up Resistance vs. Temperature
($V_{CC} = 12\text{V}$, $I_{OUT} = -100\text{mA}$)

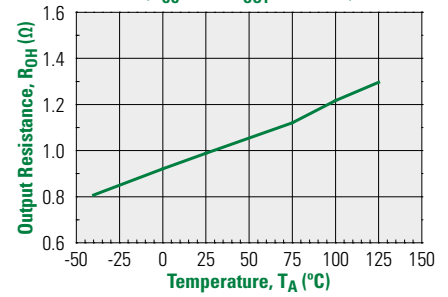

Rise Time vs. Temperature
($V_{CC} = 12\text{V}$, $C_L = 1.8\text{nF}$)

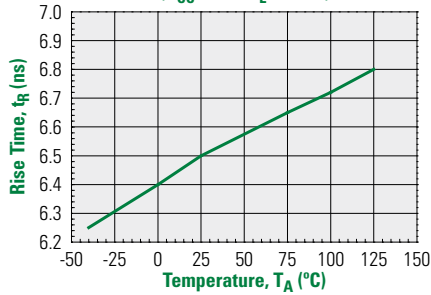

Fall Time vs. Temperature
($V_{CC} = 12\text{V}$, $C_L = 1.8\text{nF}$)

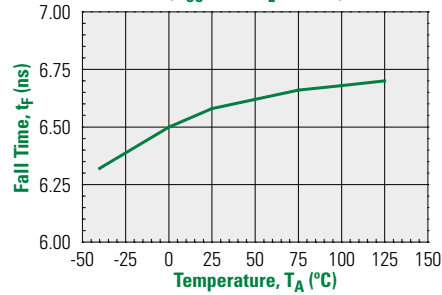

Output Pull-Down Resistance vs. Temperature
($V_{CC} = 12\text{V}$, $I_{OUT} = 100\text{mA}$)

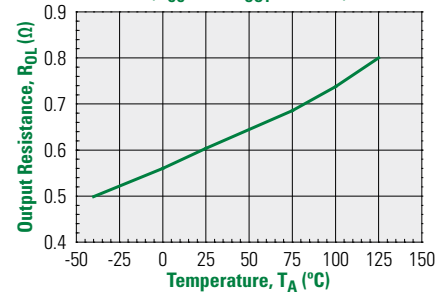

3 Manufacturing Information

3.1 Moisture Sensitivity



All plastic encapsulated semiconductor packages are susceptible to moisture ingress. Littelfuse classifies its plastic encapsulated devices for moisture sensitivity according to the latest version of the joint industry standard, **IPC/JEDEC J-STD-020**, in force at the time of product evaluation. We test all of our products to the maximum conditions set forth in the standard, and guarantee proper operation of our devices when handled according to the limitations and information in that standard as well as to any limitations set forth in the information or standards referenced below.

Failure to adhere to the warnings or limitations as established by the listed specifications could result in reduced product performance, reduction of operable life, and/or reduction of overall reliability.

This product carries a **Moisture Sensitivity Level (MSL)** classification as shown below, and should be handled according to the requirements of the latest version of the joint industry standard **IPC/JEDEC J-STD-033**.

Device	Moisture Sensitivity Level (MSL) Classification
All Versions	MSL 1

3.2 ESD Sensitivity



This product is **ESD Sensitive**, and should be handled according to the industry standard **JESD-625**.

3.3 Soldering Profile

Provided in the table below is the Classification Temperature (T_C) of this product and the maximum dwell time the body temperature of this device may be ($T_C - 5$)°C or greater. The classification temperature sets the Maximum Body Temperature allowed for this device during lead-free reflow processes. For through-hole devices, and any other processes, the guidelines of **J-STD-020** must be observed.

Device	Classification Temperature (T_C)	Dwell Time (T_P)	Max Reflow Cycles
All Versions	260°C	30 seconds	3

3.4 Board Wash

Littelfuse recommends the use of no-clean flux formulations. Board washing to reduce or remove flux residue following the solder reflow process is acceptable provided proper precautions are taken to prevent damage to the device. These precautions include but are not limited to: using a low pressure wash and providing a follow up bake cycle sufficient to remove any moisture trapped within the device due to the washing process. Due to the variability of the wash parameters used to clean the board, determination of the bake temperature and duration necessary to remove the moisture trapped within the package is the responsibility of the user (assembler). Cleaning or drying methods that employ ultrasonic energy may damage the device and should not be used. Additionally, the device must not be exposed to flux or solvents that are Chlorine-based or Fluorine-based.



3.5 Mechanical Dimensions

3.5.1 IX4340NE Package Dimensions

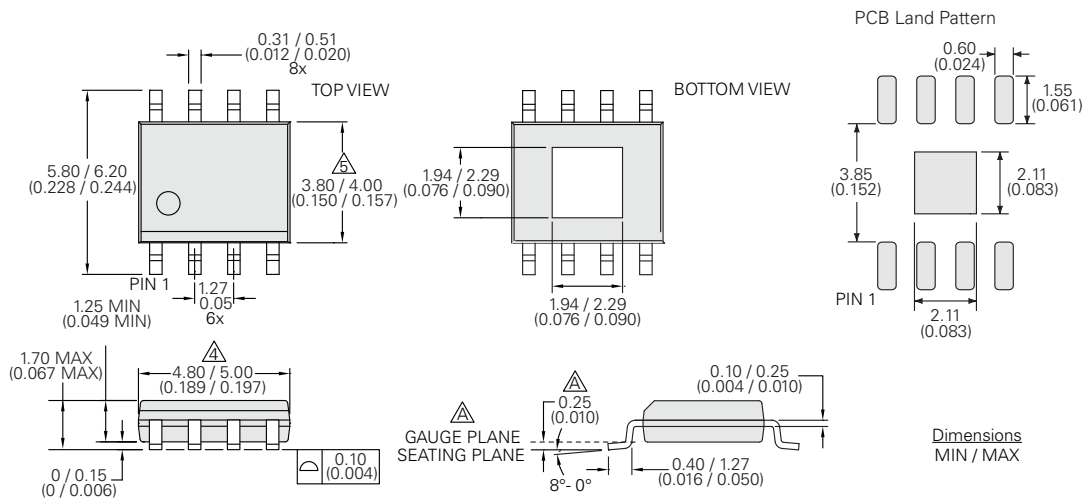

Notes:

1. Controlling dimension: millimeters.
2. All dimensions are in mm (inches).
3. This package conforms to JEDEC Standard MS-012, variation BA, Rev. F.
4. Dimension does not include mold flash, protrusions, or gate burrs. Mold flash, protrusions, or gate burrs shall not exceed 0.15mm per end.
5. Dimension does not include interlead flash or protrusion. Interlead flash or protrusion shall not exceed 0.25mm per side.
6. Lead thickness includes plating.
7. The thermal pad on the bottom of the device may be connected to GND or left floating; it must not be connected to any other signal. The thermal pad is not intended to carry current.

3.5.2 IX4340N Package Dimensions

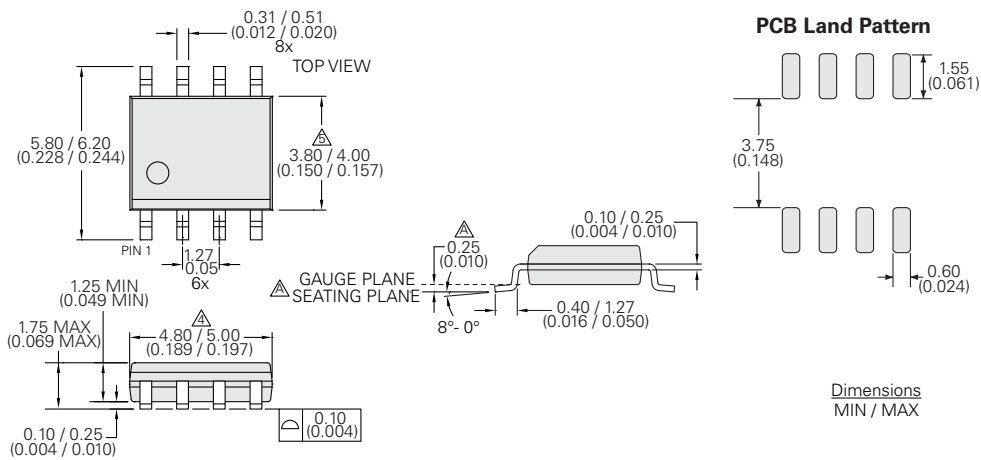

Notes:

1. Controlling dimension: millimeters.
2. All dimensions are in mm (inches).
3. This package conforms to JEDEC Standard MS-012, variation AA, Rev. F.
4. Dimension does not include mold flash, protrusions, or gate burrs. Mold flash, protrusions, or gate burrs shall not exceed 0.15mm per end.
5. Dimension does not include interlead flash or protrusion. Interlead flash or protrusion shall not exceed 0.25mm per side.
6. Lead thickness includes plating.

3.5.3 IX4340NTR & IX4340NETR Tape & Reel Dimensions

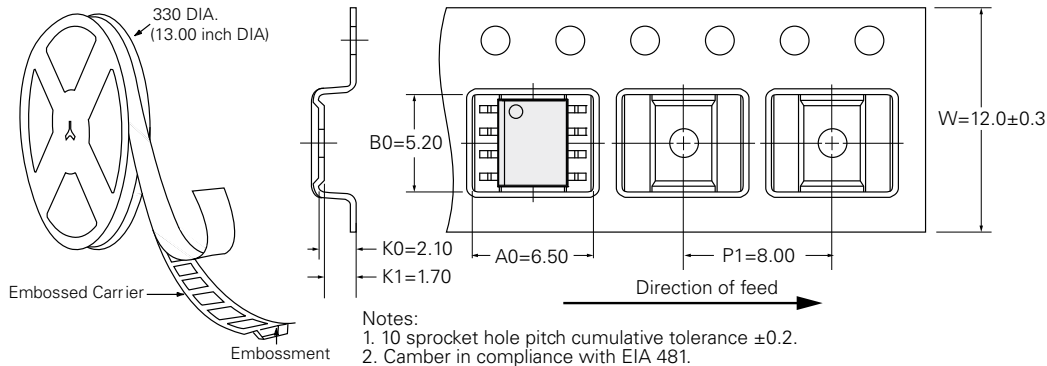

- Notes:
1. 10 sprocket hole pitch cumulative tolerance ± 0.2 .
 2. Camber in compliance with EIA 481.
 3. Pocket position relative to sprocket hole measured as true position of pocket, not pocket hole.
 4. All dimensions in millimeters.

3.5.4 IX4340UE Package Dimensions

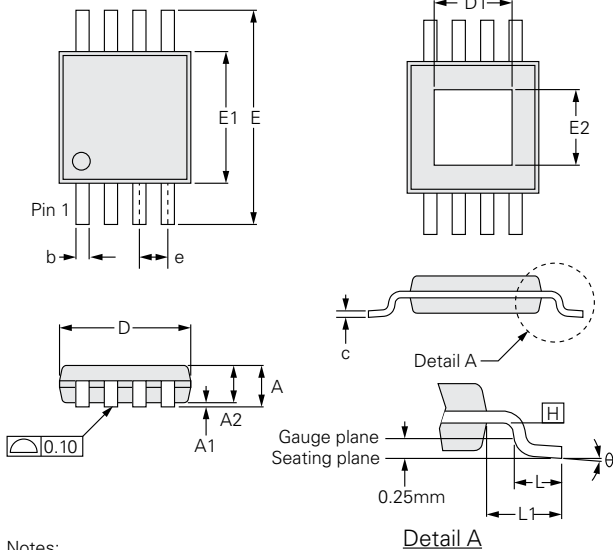

	MILLIMETERS			INCHES		
	MIN	NOM	MAX	MIN	NOM	MAX
A	-	-	1.10	-	-	0.043
A1	0.00	-	0.15	0.00	-	0.006
A2	0.75	0.85	0.95	0.030	0.033	0.037
b	0.22	-	0.38	0.009	-	0.015
c	0.08	-	0.23	0.003	-	0.009
D	3.00 BSC			0.118 BSC		
D1	1.42	-	1.93	0.056	-	0.076
E	4.90 BSC			0.193 BSC		
E1	3.00 BSC			0.118 BSC		
E2	1.38	-	1.73	0.054	-	0.068
e	0.65 BSC			0.026 BSC		
L	0.40	0.60	0.80	0.016	0.024	0.031
L1	0.95 REF			0.037 REF		
θ	0°	-	8°	0°	-	8°
LAND PATTERN						
V	-	4.30	-	-	0.169	-
W	-	1.70	-	-	0.067	-
X	-	0.45	-	-	0.018	-
Y	-	1.90	-	-	0.075	-
Z	-	1.35	-	-	0.053	-

Recommended PCB Land Pattern

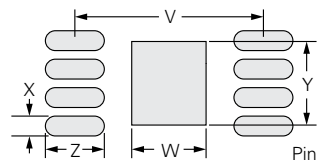

- Notes:
1. Controlling dimension: millimeters.
 2. JEDEC outline: Thermally enhanced: MO-187 AA-T.
 3. Dimension D does not include mold flash, protrusions or gate burrs. Mold flash, protrusions or gate burrs shall not exceed 0.15mm per end.
 4. Dimension "b" does not include dambar protrusion. Allowable dambar protrusion shall be 0.08mm total in excess of the "b" dimension at maximum material condition. The dambar cannot be located on the lower radius of the foot. Minimum space between protrusion and an adjacent lead shall not be less than 0.07mm.
 5. D and E1 dimensions are determined at datum [H].
 6. Lead thickness includes plating.
 7. The thermal pad on the bottom of the device may be connected to GND or left floating; it must not be connected to any other signal. The thermal pad is not intended to carry current.

3.5.5 IX4340UETR Tape & Reel Dimensions

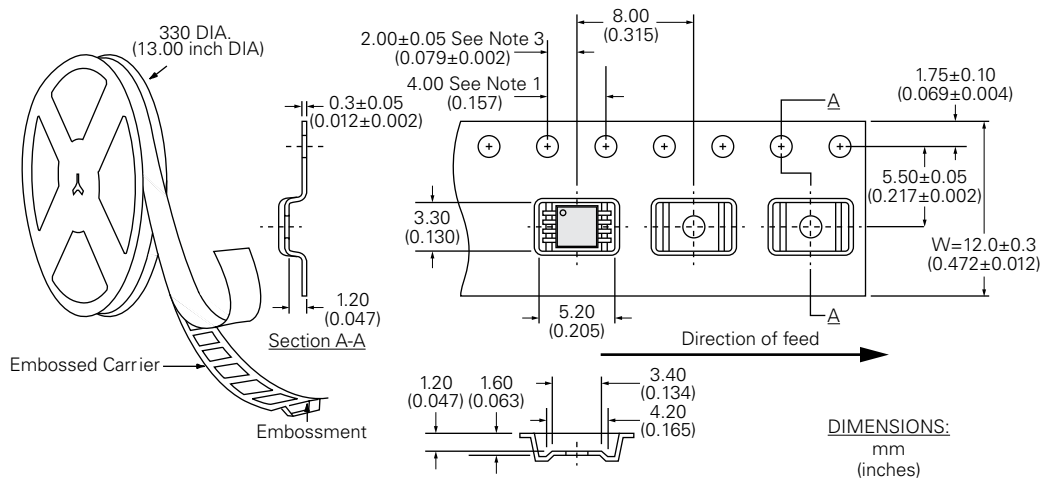

1. 10 sprocket hole pitch cumulative tolerance: ± 0.2 (0.008).
2. Camber in compliance with EIA 481.
3. Pocket position relative to sprocket hole measured as true position of pocket, not pocket hole.