



DESCRIPTION

ST3485EBDR is an RS-485 transceiver with a 3.3V power supply, half duplex, low power consumption, and fully functional compliance with TIA/EIA-485 standards.

ST3485EBDR includes a driver and a receiver, both of which can be independently enabled and disabled. When both are disabled, both the driver and receiver output a high resistance state.

ST3485EBDR has a 1/8 load and allows 256 ST3485EBDR transceivers to be connected together on the same communication bus. Can achieve error free data transmission up to 12Mbps. The working voltage range of ST3485EBDR is 3.0~3.6 V, and it has functions such as fail safe, over temperature protection, current limiting protection, and overvoltage protection.

ABSOLUTE MAXIMUM RATINGS

Supply Voltage (V_{CC}) 7V

Control Input Voltage -0.3V to +7V

Driver Input Voltage (DI) -0.3V to +7V

Driver Output Voltage (A, B) -7V to +13V

Receiver Input Voltage (A, B) -7V to +13V

Receiver Output Voltage (RO) -0.3V to +7V

Continuous Power Dissipation ($T_A = +70^\circ\text{C}$)

8-Pin SO (derate 5.88mW/ $^\circ\text{C}$ above +70 $^\circ\text{C}$)

400mW

Operating Temperature Ranges 0 $^\circ\text{C}$ to +70 $^\circ\text{C}$

Storage Temperature Range -65 $^\circ\text{C}$ to +150 $^\circ\text{C}$

Lead Temperature (soldering, 10sec) +300 $^\circ\text{C}$

PIN CONFIGURATION

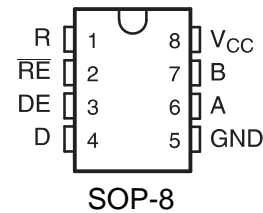

FEATURES

- 3.3V power supply, half-duplex
- 1/8 unit load, allowing up to 256 devices to be connected to the bus
- Driver short circuit output protection
- Over temperature protection function
- Low power shutdown function
- Receiver open circuit failure protection
- Has strong noise resistance
- Integrated transient voltage resistance function
- The data transmission rate in an electrical noise environment can reach 12Mbps

APPLICATIONS

- Industrial Networks
- Utility Meters
- Motor Control



DC ELECTRICAL CHARACTERISTICS

($V_{CC} = 3.3V \pm 5\%$, $T_A = T_{MIN}$ to T_{MAX} , unless otherwise noted.)

PARAMETER	SYMBOL	CONDITIONS	MIN	TYP	MAX	UNITS
Differential Driver Output (no load)	V_{OD1}			3.3		V
Differential Driver Output (with load)	V_{OD2}	$R = 54\Omega$ (RS-422)	1.5		V_{CC}	V
		$R = 100\Omega$ (RS-485)	2		V_{CC}	
Change in Magnitude of Driver Differential Output Voltage for Complementary Output States	ΔV_{OD}	$R = 54\Omega$			0.2	V
Driver Common-Mode Output Voltage	V_{OC}	$R = 54\Omega$			3	V
Change in Magnitude of Driver Common-Mode Output Voltage for Complementary Output States	ΔV_{OD}	$R = 54$			0.2	V
Input High Voltage	V_{IH}	DE, DI, \overline{RE}	2.0			V
Input Low Voltage	V_{IL}	DE, DI, \overline{RE}			0.8	V
Input Current	I_{IN1}	DE, DI, RE			± 2	μA
Input Current (A, B)	I_{IN2}	DE = 0V; $V_{CC} = 0V$ or 3.3V,	$V_{IN} = 12V$		125	μA
			$V_{IN} = -7V$	-100		
Receiver Differential Threshold Voltage	V_{TH}	$-7V \leq V_{CM} \leq 12V$	-0.2		0.2	V
Receiver Input Hysteresis	ΔV_{TH}	$V_{CM} = 0V$	10	30		mV
Receiver Output High Voltage	V_{OH}	$I_o = -2.5mA$, $V_{ID} = 200mV$	$V_{CC}-1.5$			V
Receiver Output Low Voltage	V_{OL}	$I_o = 2.5mA$, $V_{ID} = -200mV$			0.4	V
Three-State (high impedance) Output Current at Receiver	I_{OZR}	$0.4V \leq V_o \leq 2.4V$			± 1	μA
Receiver Input Resistance	R_{IN}	$-7V \leq V_{CM} \leq 12V$	96			k Ω

DC ELECTRICAL CHARACTERISTICS (continued)

($V_{CC} = 3.3V \pm 5\%$, $T_A = T_{MIN}$ to T_{MAX} , unless otherwise noted.)

PARAMETER	SYMBOL	CONDITIONS	MIN	TYP	MAX	UNITS
No-Load Supply Current	I_{CC}	DE = V_{CC}		520	800	μA
		$\overline{RE} = 0V$ or V_{CC}		540	700	
		DE = 0V				
Driver Short-Circuit Current,	I_{OSD}				± 250	mA



SWITCHING CHARACTERISTICS

(V_{CC} = 5V ±5%, T_A = T_{MIN} to T_{MAX}, unless otherwise noted.) (Notes 1, 2)

PARAMETER	SYMBOL	CONDITIONS	MIN	TYP	MAX	UNITS
Driver Input to Output	t _{PLH}	R _{DIFF} = 27Ω		8	35	ns
	t _{PHL}	C _{L1} = C _{L2} = 100pF		8	35	
Driver Output Skew to Output	t _{SKEW}	R _{DIFF} = 60Ω, C _{L1} = C _{L2} = 100pF		10	35	ns
Driver Enable to Output High	t _{ZH}	C _L = 110pF, S2 closed		20	90	ns
Driver Enable to Output Low	t _{ZL}	C _L = 110pF, S1 closed		20	90	ns
Driver Disable Time from Low	t _{LZ}	C _L = 110pF, S1 closed		20	80	ns
Driver Disable Time from High	t _{HZ}	C _L = 110pF, S2 closed		20	80	ns
t _{PLH} - t _{PHL} Differential	t _{SKD}	R _{DIFF} = 54Ω		7	10	ns
Receiver Skew		C _{L1} = C _{L2} = 100pF				
Receiver Enable to Output Low	t _{ZL}	C _{RL} = 15pF, S1 closed		20	45	ns
Receiver Enable to Output High	t _{ZH}	C _{RL} = 15pF, S2 closed		20	45	ns
Receiver Disable Time from Low	t _{LZ}	C _{RL} = 15pF, S1 closed		200	1400	ns
Receiver Disable Time from High	t _{HZ}	C _{RL} = 15pF, S2 closed		200	1400	ns

TABLE OF ST3485EBDR OPERATION

Transmission					Receipt			
Inputs			Outputs X		Inputs			Outputs
RE	DE	DI	A	B	RE	DE	A-B	RO
X	1	1	H	L	0	X	+0.2V	H
X	1	0	L	H	0	X	-0.2V	L
0	0	X	Z	Z	0	X	On/Short Circuit	H
1	0	X	Z(shutdown)		1	X	X	Z

X-Any level

Z-High resistance



TEST CIRCUITS

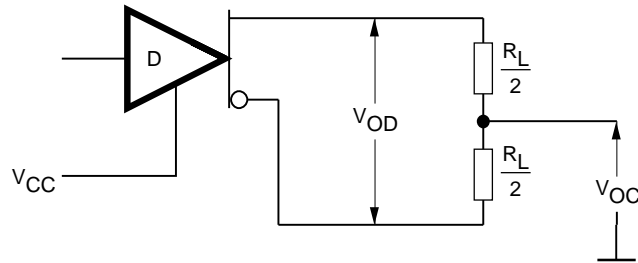

Driver and VOC test load

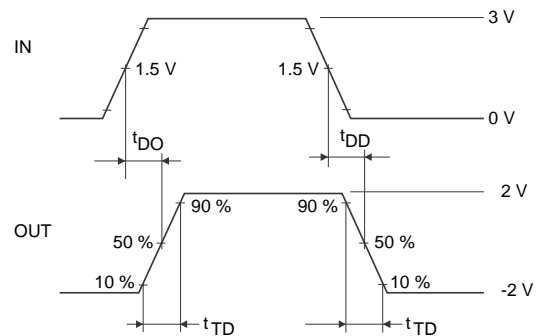
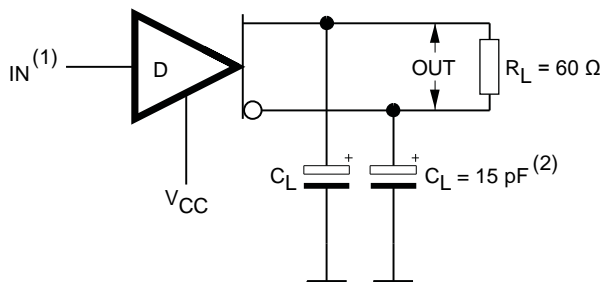

Driver differential delay and transition time

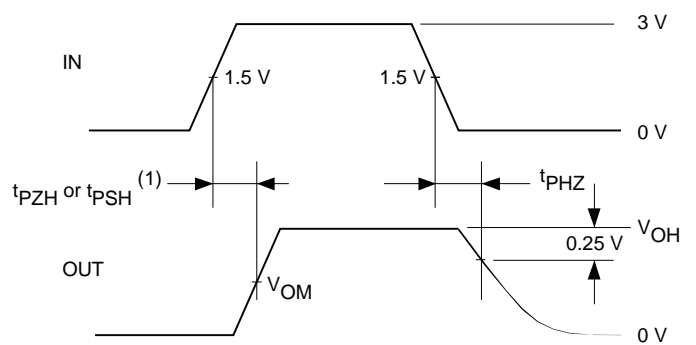
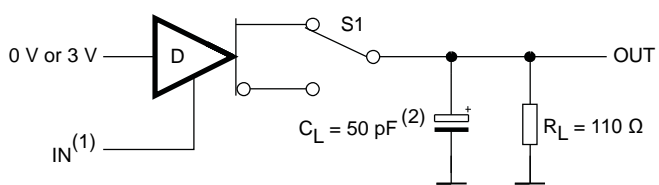

Drive propagation delay

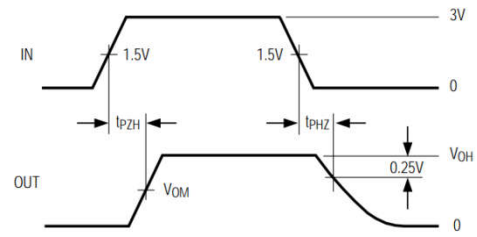
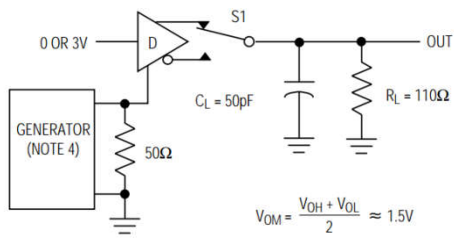

Drive enable and disable time

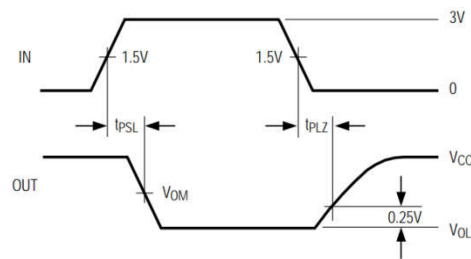
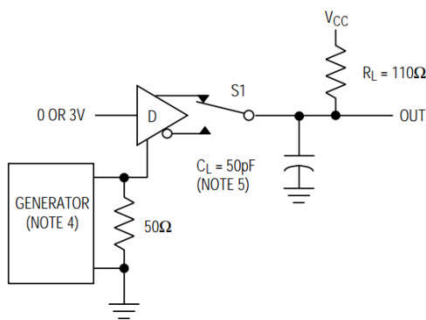

Drive enable and disable times test circuit (pull-up configuration)

TYPICAL CHARACTERISTICS

Receiver output current vs. output low voltage

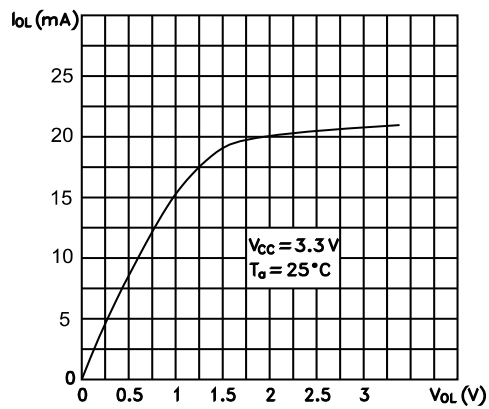

Receiver output current vs. output high voltage

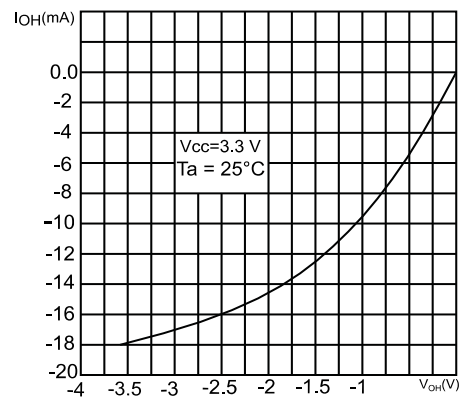



Low level driver output capability

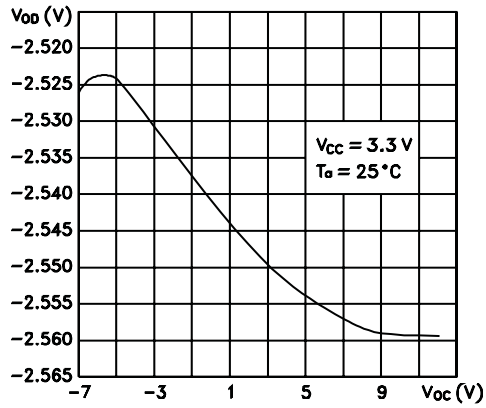

High level driver output capability

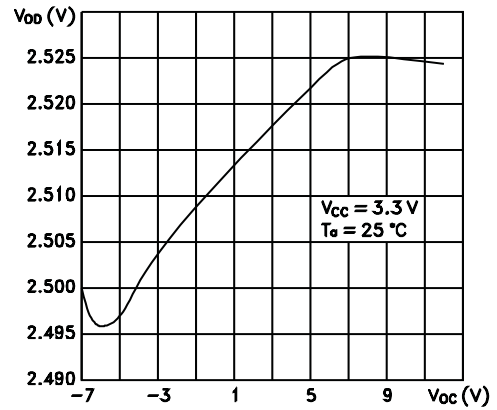

Receiver input characteristics

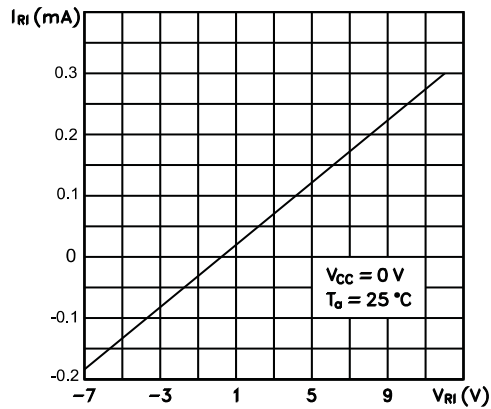

Driver short-circuit current

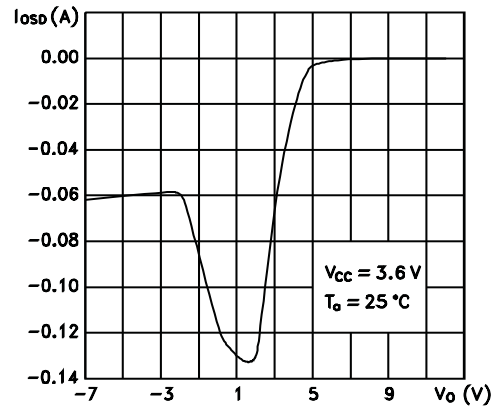

Driver short-circuit current

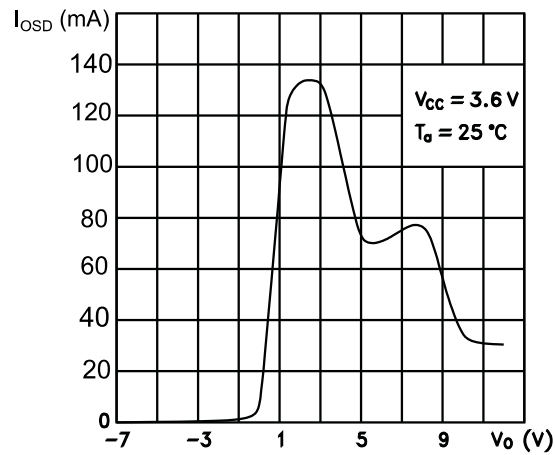



PACKAGE OUTLINE DIMENSIONS

SOP-8

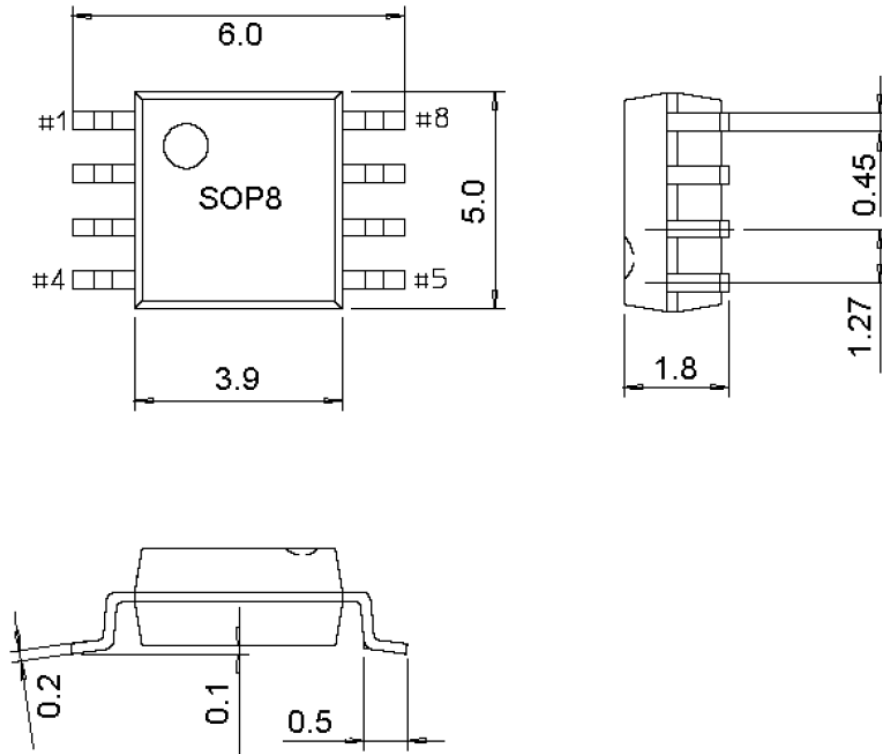



Attention

- Any and all HUA XUAN YANG ELECTRONICS products described or contained herein do not have specifications that can handle applications that require extremely high levels of reliability, such as life-support systems, aircraft's control systems, or other applications whose failure can be reasonably expected to result in serious physical and/or material damage. Consult with your HUA XUAN YANG ELECTRONICS representative nearest you before using any HUA XUAN YANG ELECTRONICS products described or contained herein in such applications.
- HUA XUAN YANG ELECTRONICS assumes no responsibility for equipment failures that result from using products at values that exceed, even momentarily, rated values (such as maximum ratings, operating condition ranges, or other parameters) listed in products specifications of any and all HUA XUAN YANG ELECTRONICS products described or contained herein.
- Specifications of any and all HUA XUAN YANG ELECTRONICS products described or contained herein stipulate the performance, characteristics, and functions of the described products in the independent state, and are not guarantees of the performance, characteristics, and functions of the described products as mounted in the customer's products or equipment. To verify symptoms and states that cannot be evaluated in an independent device, the customer should always evaluate and test devices mounted in the customer's products or equipment.
- HUA XUAN YANG ELECTRONICS CO.,LTD. strives to supply high-quality high-reliability products. However, any and all semiconductor products fail with some probability. It is possible that these probabilistic failures could give rise to accidents or events that could endanger human lives, that could give rise to smoke or fire, or that could cause damage to other property. When designing equipment, adopt safety measures so that these kinds of accidents or events cannot occur. Such measures include but are not limited to protective circuits and error prevention circuits for safe design, redundant design, and structural design.
- In the event that any or all HUA XUAN YANG ELECTRONICS products(including technical data, services) described or contained herein are controlled under any of applicable local export control laws and regulations, such products must not be exported without obtaining the export license from the authorities concerned in accordance with the above law.
- No part of this publication may be reproduced or transmitted in any form or by any means, electronic or mechanical, including photocopying and recording, or any information storage or retrieval system, or otherwise, without the prior written permission of HUA XUAN YANG ELECTRONICS CO.,LTD.
- Information (including circuit diagrams and circuit parameters) herein is for example only ; it is not guaranteed for volume production. HUA XUAN YANG ELECTRONICS believes information herein is accurate and reliable, but no guarantees are made or implied regarding its use or any infringements of intellectual property rights or other rights of third parties.
- Any and all information described or contained herein are subject to change without notice due to product/technology improvement, etc. When designing equipment, refer to the "Delivery Specification" for the HUA XUAN YANG ELECTRONICS product that you intend to use.