

MCV 1,5/ 7-G-3,5 - PCB header



1843651

<https://www.phoenixcontact.com/pc/products/1843651>

Please be informed that the data shown in this PDF document is generated from our online catalog. Please find the complete data in the user documentation. Our general terms of use for downloads are valid.

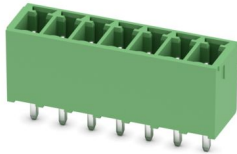

PCB headers, nominal cross section: 1.5 mm², color: green, nominal current: 8 A, rated voltage (III/2): 160 V, contact surface: Sn, contact connection type: Pin, number of potentials: 7, number of rows: 1, number of positions: 7, number of connections: 7, product range: MCV 1,5/..-G, pitch: 3.5 mm, mounting: Wave soldering, pin layout: Linear pinning, solder pin [P]: 3.4 mm, number of solder pins per potential: 1, plug-in system: COMBICON MC 1,5, Pin connector pattern alignment: Standard, locking: without, mounting method: without, type of packaging: packed in cardboard

Your advantages

- Well-known mounting principle allows worldwide use
- Vertical connection enables multi-row arrangement on the PCB
- Maximum flexibility when it comes to device design – one header for connectors with different connection technologies

Commercial data

Item number	1843651
Packing unit	100 pc
Minimum order quantity	100 pc
Product key	AABSAE
Catalog page	Page 226 (C-1-2013)
GTIN	4017918112806
Weight per piece (including packing)	1.875 g
Weight per piece (excluding packing)	1.732 g
Customs tariff number	85366930
Country of origin	DE

MCV 1,5/ 7-G-3,5 - PCB header



1843651

<https://www.phoenixcontact.com/pc/products/1843651>

Technical data

Product properties

Product type	PCB headers
Product family	MCV 1,5/..-G
Product line	COMBICON Connectors S
Type	Standard
Number of positions	7
Pitch	3.5 mm
Number of connections	7
Number of rows	1
Number of potentials	7
Mounting flange	without
Pin layout	Linear pinning
Solder pins per potential	1

Electrical properties

Nominal current I_N	8 A
Nominal voltage U_N	160 V
Contact resistance	1.8 mΩ
Rated voltage (III/3)	160 V
Rated surge voltage (III/3)	2.5 kV
Rated voltage (III/2)	160 V
Rated surge voltage (III/2)	2.5 kV
Rated voltage (II/2)	250 V
Rated surge voltage (II/2)	2.5 kV

Mounting

Mounting type	Wave soldering
Pin layout	Linear pinning

Material specifications

Material data - contact

Note	WEEE/RoHS-compliant, free of whiskers according to IEC 60068-2-82/JEDEC JESD 201
Contact material	Cu alloy
Surface characteristics	Tin-plated
Metal surface contact area (top layer)	Tin (3 - 5 μm Sn)
Metal surface contact area (middle layer)	Nickel (1 - 3 μm Ni)
Metal surface soldering area (top layer)	Tin (3 - 5 μm Sn)
Metal surface soldering area (middle layer)	Nickel (1 - 3 μm Ni)

Material data - housing

Color (Housing)	green (6021)
-----------------	--------------

MCV 1,5/ 7-G-3,5 - PCB header

1843651

<https://www.phoenixcontact.com/pc/products/1843651>

Insulating material	PBT
Insulating material group	IIIa
CTI according to IEC 60112	225
Flammability rating according to UL 94	V0

Dimensions

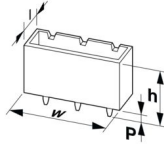
Dimensional drawing	
Pitch	3.5 mm
Width [w]	25.9 mm
Height [h]	12.6 mm
Length [l]	7.25 mm
Installed height	9.2 mm
Solder pin length [P]	3.4 mm
Pin dimensions	0.8 x 0.8 mm

PCB design

Hole diameter	1.2 mm
---------------	--------

Mechanical tests

Visual inspection

Specification	IEC 60512-1-1:2002-02
Result	Test passed

Dimension check

Specification	IEC 60512-1-2:2002-02
Result	Test passed

Resistance of inscriptions

Specification	IEC 60068-2-70:1995-12
Result	Test passed

Polarization and coding

Specification	IEC 60512-13-5:2006-02
Result	Test passed

Contact holder in insert

Specification	IEC 60512-15-1:2008-05
Contact holder in insert Requirements >20 N	Test passed

Insertion and withdrawal forces

Result	Test passed
--------	-------------

MCV 1,5/ 7-G-3,5 - PCB header



1843651

<https://www.phoenixcontact.com/pc/products/1843651>

No. of cycles	25
Insertion strength per pos. approx.	6 N
Withdraw strength per pos. approx.	4 N

Electrical tests

Thermal test | Test group C

Specification	IEC 60512-5-1:2002-02
Tested number of positions	20

Insulation resistance

Specification	IEC 60512-3-1:2002-02
Insulation resistance, neighboring positions	> 5 MΩ

Air clearances and creepage distances |

Specification	IEC 60664-1:2007-04
Insulating material group	IIIa
Comparative tracking index (IEC 60112)	CTI 225
Rated insulation voltage (III/3)	160 V
Rated surge voltage (III/3)	2.5 kV
minimum clearance value - non-homogenous field (III/3)	1.5 mm
minimum creepage distance (III/3)	2.5 mm
Rated insulation voltage (III/2)	160 V
Rated surge voltage (III/2)	2.5 kV
minimum clearance value - non-homogenous field (III/2)	1.5 mm
minimum creepage distance (III/2)	1.6 mm
Rated insulation voltage (II/2)	250 V
Rated surge voltage (II/2)	2.5 kV
minimum clearance value - non-homogenous field (II/2)	1.5 mm
minimum creepage distance (II/2)	2.5 mm

Environmental and real-life conditions

Vibration test

Specification	IEC 60068-2-6:2007-12
Frequency	10 - 150 - 10 Hz
Sweep speed	1 octave/min
Amplitude	0.35 mm (10 Hz ... 60.1 Hz)
Acceleration	5g (60.1 Hz ... 150 Hz)
Test duration per axis	2.5 h
Test directions	X-, Y- and Z-axis

Durability test

Specification	IEC 60512-5:1992-08
Impulse withstand voltage at sea level	2.95 kV
Contact resistance R ₁	1.8 mΩ

MCV 1,5/ 7-G-3,5 - PCB header



1843651

<https://www.phoenixcontact.com/pc/products/1843651>

Contact resistance R_2	2.2 m Ω
Insertion/withdrawal cycles	25

Climatic test

Specification	ISO 6988:1985-02
Corrosive stress	0.2 dm ³ SO ₂ on 300 dm ³ /40 °C/1 cycle
Thermal stress	100 °C/168 h
Power-frequency withstand voltage	1.39 kV

Ambient conditions

Ambient temperature (operation)	-40 °C ... 100 °C (dependent on the derating curve)
Ambient temperature (storage/transport)	-40 °C ... 70 °C
Relative humidity (storage/transport)	30 % ... 70 %
Ambient temperature (assembly)	-5 °C ... 100 °C

Packaging specifications

Type of packaging	packed in cardboard
-------------------	---------------------

Drawings

Diagram

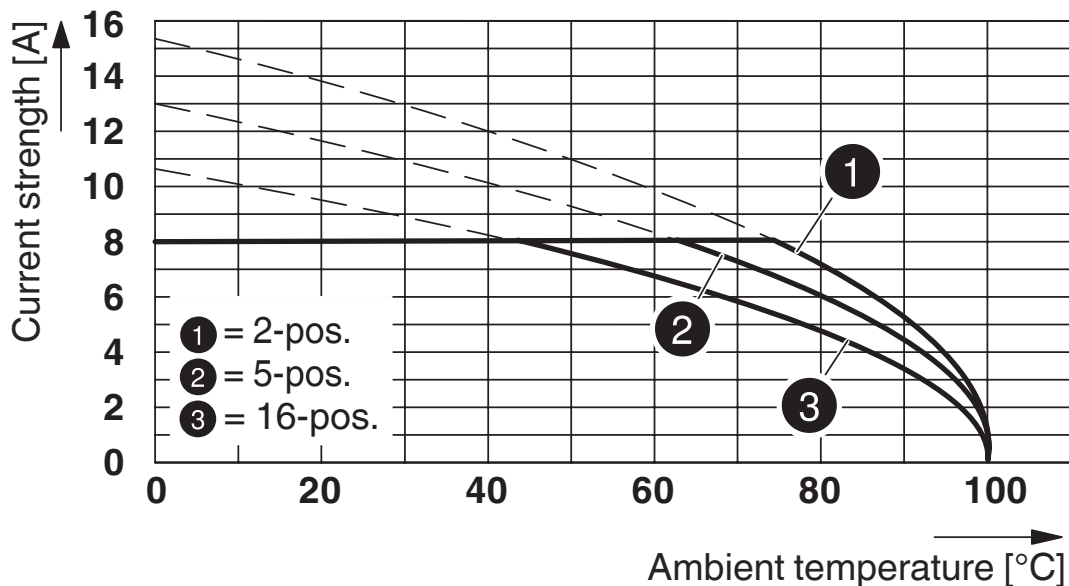

Type: MCVW 1,5/...-ST-3,5 with MCV 1,5/...-G-3,5

Diagram

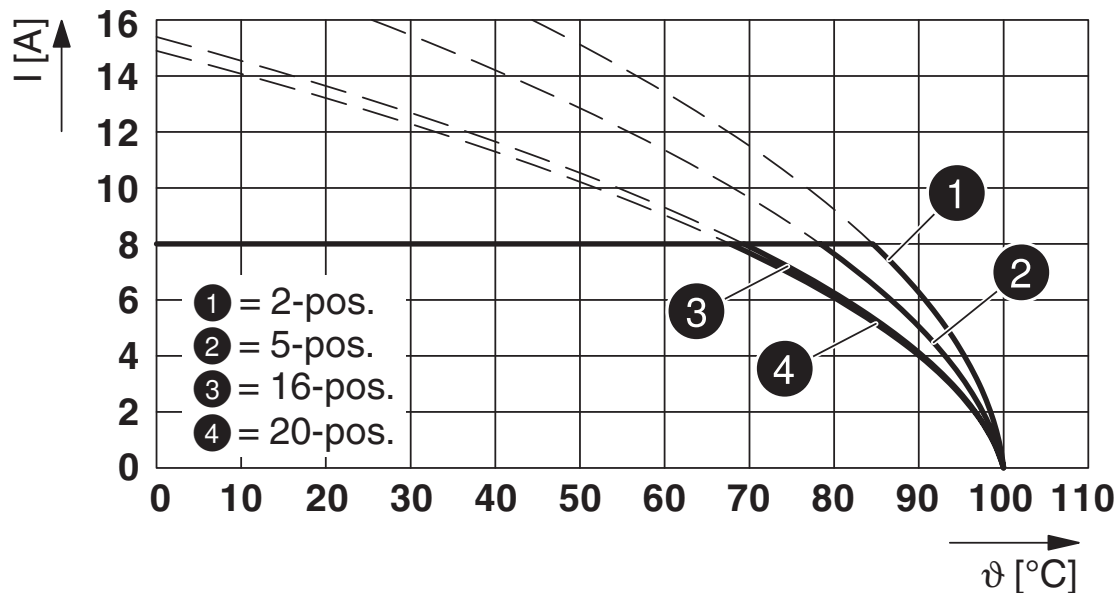

Type: FMC 1,5/...-ST-3,5 with MCV 1,5/...-G-3,5

MCV 1,5/ 7-G-3,5 - PCB header

1843651

<https://www.phoenixcontact.com/pc/products/1843651>

Diagram

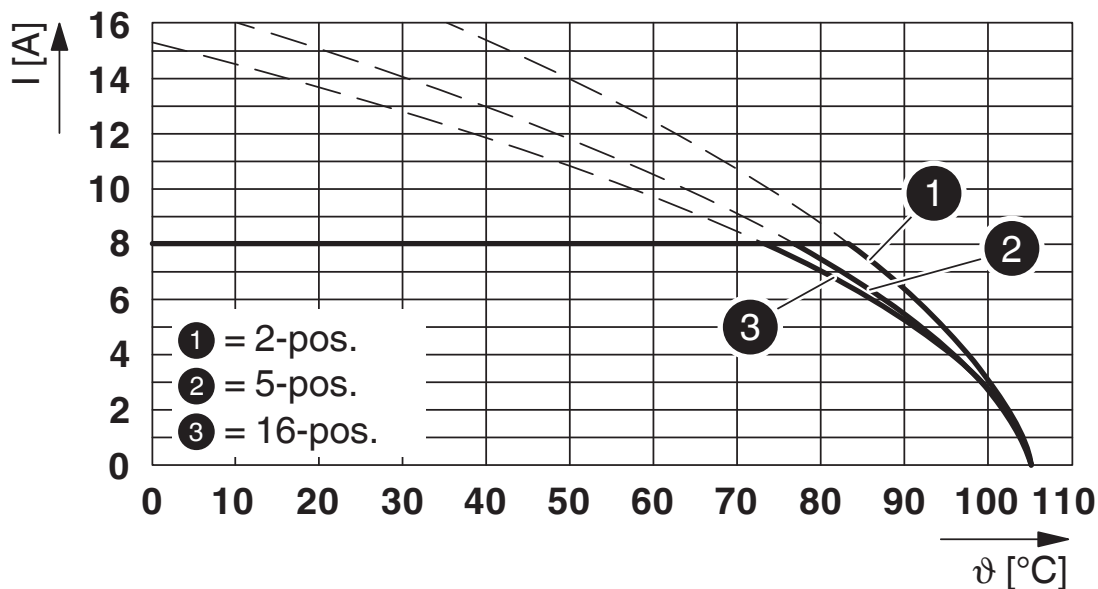

Type: XPC 1,5/...-ST-3,5 with MCV 1,5/...-G-3,5

Dimensional drawing

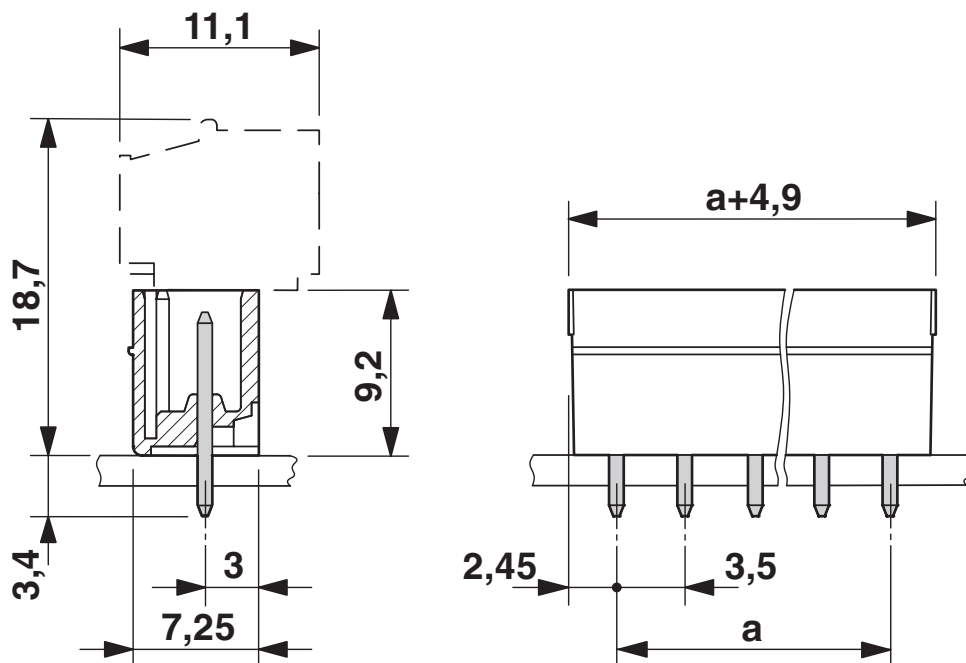

MCV 1,5/ 7-G-3,5 - PCB header

1843651

<https://www.phoenixcontact.com/pc/products/1843651>

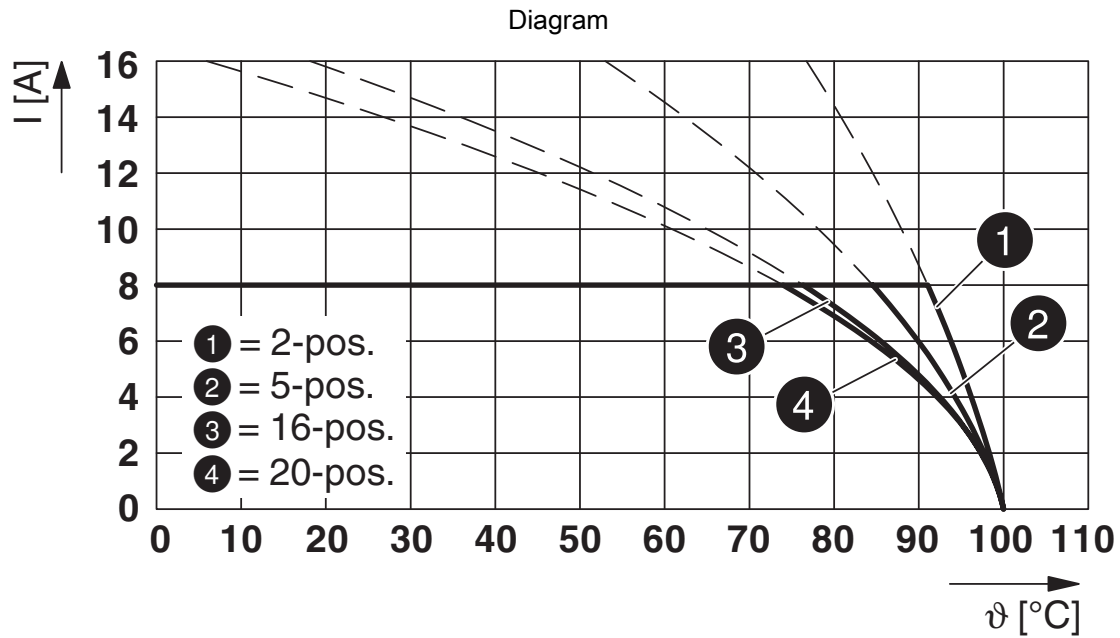

Type: FK-MCP 1,5/...-ST-3,5 with MCV 1,5/...-G-3,5

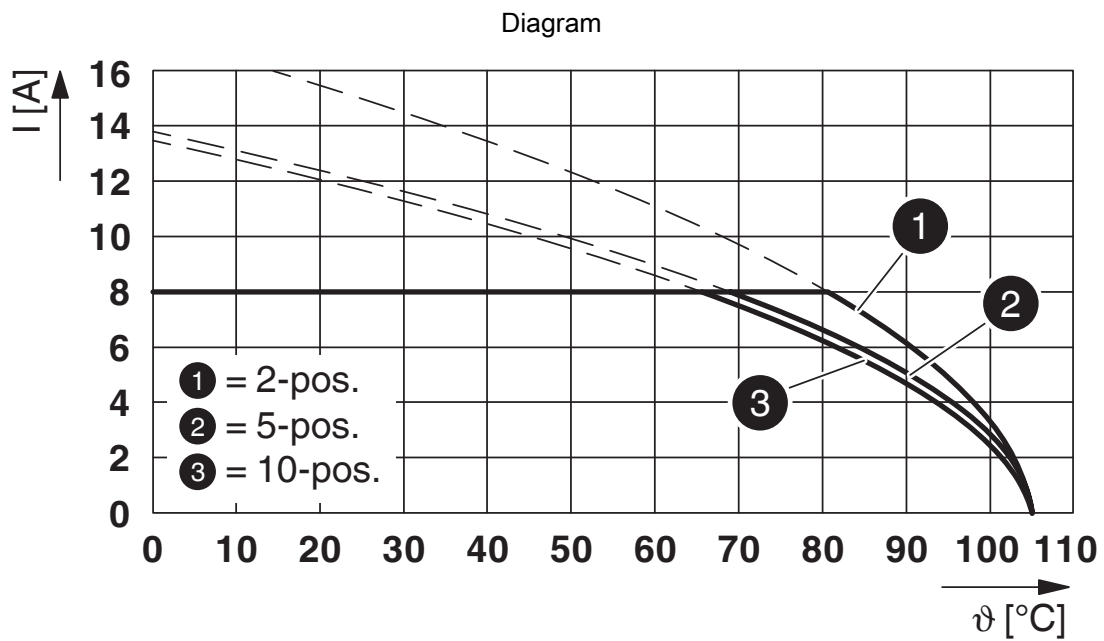

Type: TFMC 1,5/...-ST-3,5 with MCV 1,5/...-G-3,5

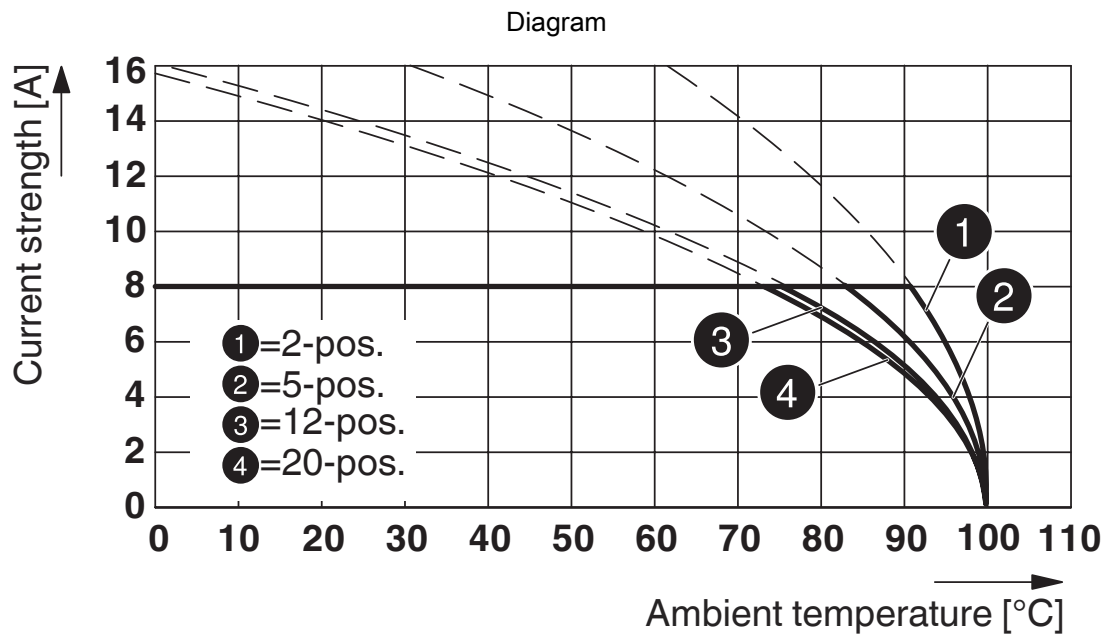

Type: MC 1,5/...-ST-3,5 with MCV 1,5/...-G-3,5

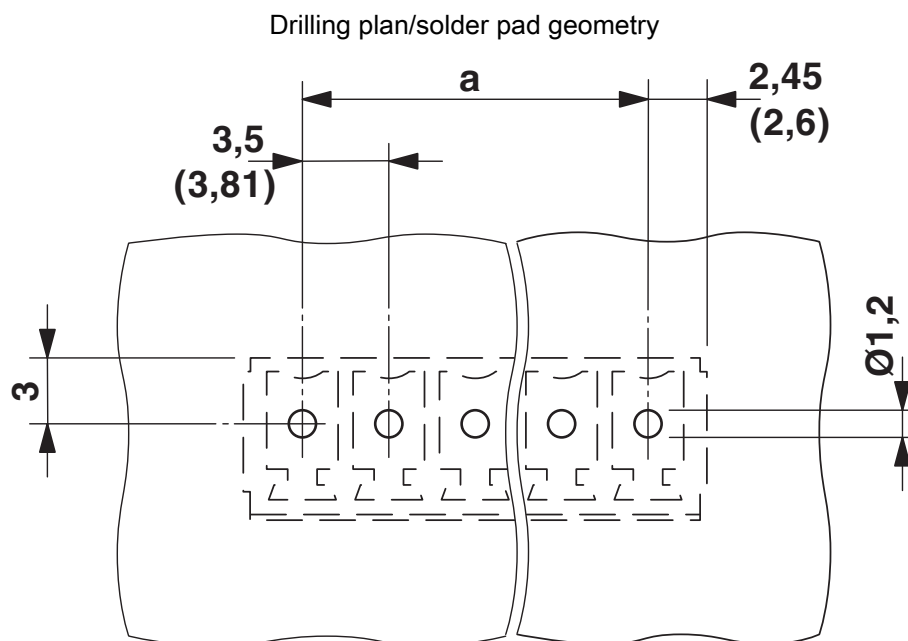

MCV 1,5/ 7-G-3,5 - PCB header



1843651

<https://www.phoenixcontact.com/pc/products/1843651>

Approvals

To download certificates, visit the product detail page: <https://www.phoenixcontact.com/pc/products/1843651>



VDE Zeichengenehmigung

Approval ID: 40011723



CSA

Approval ID: 13631

	Nominal voltage U_N	Nominal current I_N	Cross section AWG	Cross section mm^2
Use group B				
	300 V	8 A	-	-
Use group D				
	300 V	8 A	-	-



cULus Recognized

Approval ID: E60425-20110128

	Nominal voltage U_N	Nominal current I_N	Cross section AWG	Cross section mm^2
Use group B				
	300 V	8 A	-	-
Use group D				
	300 V	8 A	-	-



VDE Zeichengenehmigung

Approval ID: 40011723



VDE Zeichengenehmigung

Approval ID: 40057836

	Nominal voltage U_N	Nominal current I_N	Cross section AWG	Cross section mm^2
	160 V	8 A	-	-

MCV 1,5/ 7-G-3,5 - PCB header



1843651

<https://www.phoenixcontact.com/pc/products/1843651>

Classifications

ECLASS

ECLASS-11.0	27460201
ECLASS-12.0	27460201
ECLASS-13.0	27460201

ETIM

ETIM 9.0	EC002637
----------	----------

UNSPSC

UNSPSC 21.0	39121400
-------------	----------

MCV 1,5/ 7-G-3,5 - PCB header



1843651

<https://www.phoenixcontact.com/pc/products/1843651>

Environmental product compliance

EU RoHS

Fulfills EU RoHS substance requirements	Yes, No exemptions
---	--------------------

China RoHS

Environment friendly use period (EFUP)	EFUP-E
	No hazardous substances above the limits

EU REACH SVHC

REACH candidate substance (CAS No.)	No substance above 0.1 wt%
-------------------------------------	----------------------------

Phoenix Contact 2025 © - all rights reserved
<https://www.phoenixcontact.com>

PHOENIX CONTACT GmbH & Co. KG
Flachmarktstraße 8
D-32825 Blomberg
+49 (0) 5235-3 00
info@phoenixcontact.com