

MORNSUN®

WRE_S - 3WR2 & WRF_S - 3WR2 Series 3W, WIDE INPUT, ISOLATED & REGULATED DUAL/SINGLE OUTPUT DC-DC CONVERTER

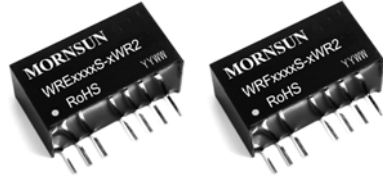

Patent Protected RoHS

PART NUMBER SYSTEM

WRF1205S-3WR2

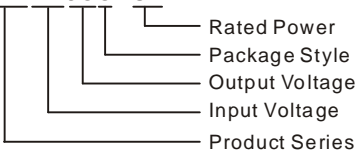

FEATURES

- Ultra-Miniature SIP Package
- 2:1 wide input voltage range
- Temperature range: -40°C ~ +85°C
- 3KVDC isolation
- Short circuit protection(automatic recovery)
- External On/Off control
- High power density

APPLICATION

The WRE_S-3WR2 & WRF_S-3WR2 Series are specially designed for applications where a wide range input voltage power supplies are isolated from the input power supply in a distributed power supply system on a circuit board. For these DC-DC converters, You can reduce the design point of failure and save the development of micro power supply's manpower, material and time costs, also better ensure product quality stability, protect safety and reliability of the end of products.

These products apply to where:

- 1) Input voltage range $\leq 2:1$;
- 2) 3KVDC input and output isolation;
- 3) Regulated and low ripple noise is required.

Such as: industrial control, telecommunication etc.

SELECTION GUIDE

Model	Input Voltage(VDC)		Output Voltage (VDC)	Output Current (mA)		Input Current (mA)(Typ.)		Reflected Ripple Current (mA, Typ.)	Max. Capacitive Load ^② (μF)	Efficiency (% Typ.) @Max. Load
	Nominal (Range)	Max. ^①		Max.	Min.	@Max. Load	@No Load			
WRE0505S-3WR2	5 (4.5-9)	11	±5	±250	±13	676	40	30	1000	74
WRE0512S-3WR2			±12	±104	±5	650			470	77
WRE0515S-3WR2			±15	±83	±4	650			330	77
WRF0505S-3WR2			5	500	25	685			2200	73
WRF0509S-3WR2			9	278	14	676			1000	74
WRF0512S-3WR2			12	208	10	650			680	77
WRF0515S-3WR2			15	167	8	676			470	74
WRE1205S-3WR2	12 (9-18)	20	±5	±300	±15	321	20	30	1000	78
WRE1212S-3WR2			±12	±125	±6	317			470	79
WRE1215S-3WR2			±15	±100	±5	313			330	80
WRF1203S-3WR2			3.3	758	38	278			2700	75
WRF1205S-3WR2			5	600	30	329			2200	76
WRF1209S-3WR2			9	333	17	317			1000	79
WRF1212S-3WR2			12	250	13	305			680	82
WRF1215S-3WR2	15	200	10	302	470	83				
WRF1224S-3WR2	24	125	6	309	330	81				
WRE2405S-3WR2	24 (18-36)	40	±5	±300	±15	158	7	110	1000	79
WRE2409S-3WR2			±9	±167	±8	155			680	81
WRE2412S-3WR2			±12	±125	±6	151			470	83
WRE2415S-3WR2			±15	±100	±5	151			330	83
WRF2403S-3WR2			3.3	758	38	141			2700	74
WRF2405S-3WR2			5	600	30	155			2200	81
WRF2409S-3WR2			9	333	17	151			1000	83
WRF2412S-3WR2			12	250	13	151			680	83
WRF2415S-3WR2			15	200	10	151			470	83
WRF2424S-3WR2			24	125	6	151			330	83

WRE4805S-3WR2	48 (36-75)	80	±5	±300	±15	79	7	45	1000	79
WRE4812S-3WR2			±12	±125	±6	76			470	82
WRE4815S-3WR2			±15	±100	±5	76			330	82
WRF4803S-3WR2			3.3	758	38	70			2700	75
WRF4805S-3WR2			5	600	30	82			2200	76
WRF4812S-3WR2			12	250	13	78			680	80
WRF4815S-3WR2			15	200	10	75			470	84
WRF4824S-3WR2			24	125	6	77			330	82

Note: ①. Absolute maximum rating without damage on the converter, but it isn't recommended;
②. For dual output converter, the given value is the same for each output.

INPUT SPECIFICATIONS

Item	Test Conditions	Min.	Typ.	Max.	Unit
Input Surge Voltage (1sec. max.)	5V input	-0.7	--	12	VDC
	12V input	-0.7	--	25	
	24V input	-0.7	--	50	
	48V input	-0.7	--	100	
Start-up Voltage	5V input	3.5	4	4.5	
	12V input	4.5	8	9	
	24V input	11	16	18	
	48V input	24	33	36	
Input Filter		C Filter			
Ctrl*	Models ON	Ctrl open or be insulated			
	Models OFF	Connect high level voltage, and ensure the current into Ctrl to be 5-10mA			

Note: *Please refer to "DESIGN CONSIDERATIONS" as the direction for use of Ctrl.

OUTPUT SPECIFICATIONS

Item	Test Conditions	Min.	Typ.	Max.	Unit
Output Voltage Accuracy	5% to 100% load	--	±1	±3	%
No-load Output Voltage Accuracy ①	Input voltage range	--	±1.5	±5	
Output Voltage Balance	Dual output, balanced loads	--	±0.5	±1	
Line Regulation	Full load, Input voltage from low to high	--	±0.2	±0.5	
Load Regulation	5% to 100% load	--	±0.6	±1	
Transient Recovery Time	25% load step change	--	0.5	3	ms
Transient Response Deviation		--	±2.5	±5	%
Temperature coefficient	100% load	--	±0.02	±0.03	%/°C
Ripple ②	20MHz Bandwidth	--	30	45	mVp-p
Noise ②		--	50	100	
Output Short Circuit Protection		Continuous, automatic recovery			

Note: ①. The max. no-load output voltage accuracy for WRF1203S-3WR2 and WRF4803S-3WR2 is ± 8%;
②. Ripple and noise tested with "parallel cable" method. See detailed operation instructions at DC-DC application notes;
The max. output ripple for WRE2405S-3WR2 is 65mVp-p.

COMMON SPECIFICATIONS

Item	Test Conditions	Min.	Typ.	Max.	Unit
Isolation Voltage	Input-Output, Tested for 1 minute, leakage current less than 1 mA	3000	--	--	VDC
Isolation Resistance	Input-Output, Test at 500VDC	1000	--	--	MΩ
Isolation Capacitance	Input-Output, 100KHz/0.1V	--	30	50	pF
Switching Frequency(PFM Mode)	100% load, nominal input voltage	--	250	--	KHz
MTBF	MIL-HDBK-217F @25°C	1000	--	--	K hours
Case Material		Plastic (UL94-V0)			
Weight		--	4.9	--	g

ENVIRONMENTAL SPECIFICATIONS

Item	Test Conditions	Min.	Typ.	Max.	Unit
Storage Humidity	Non condensing	--	--	95	%
Operating Temperature	Power derating (above85°C, see Figure 5)	-40	--	85	°C

Storage Temperature		-55	--	125	°C
Temp. rise at full load	Ta=25°C	--	25	--	
Lead Temperature	1.5mm from case for 10 seconds	--	--	300	
Cooling		Free air convection			

EMC SPECIFICATIONS

EMI	CE	CISPR22/EN55022 CLASS B (Recommended Circuit Refer to Figure1-② or Figure 3)			
	RE	CISPR22/EN55022 CLASS B (Recommended Circuit Refer to Figure1-② or Figure 3)			
EMS	ESD	IEC/EN61000-4-2	Contact ±4KV/ Air ±8KV	perf. Criteria B	
	RS	IEC/EN61000-4-3	10V/m	perf. Criteria A	
	EFT	IEC/EN61000-4-4	±2KV	(Recommended Circuit Refer to Figure1-①)	perf. Criteria B
		IEC/EN61000-4-4	±4KV	(Recommended Circuit Refer to Figure 3)	perf. Criteria B
	Surge	IEC/EN61000-4-5	±2KV	(Recommended Circuit Refer to Figure1-① or Figure 3)	perf. Criteria B
	CS	IEC/EN61000-4-6	3 Vr.m.s		perf. Criteria A
	Voltage dips, short and interruptions immunity	IEC/EN61000-4-29	0%-70%		perf. Criteria B

EMC RECOMMENDED CIRCUIT

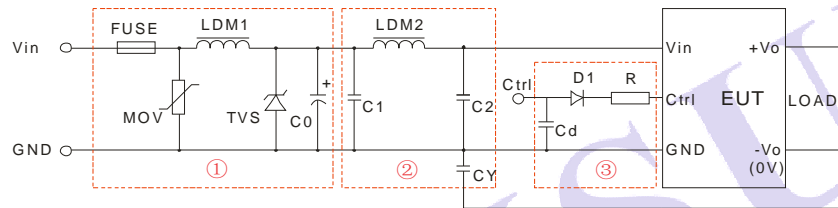

(Figure1)

Recommended external circuit parameters:

Model	Vin: 5V	Vin:12V	Vin:24V	Vin:48V
FUSE	Choose according to practical input current			
MOV	--	--	S14K35	S14K60
LDM1	--	--	56μH	56μH
TVS	SMCJ13A	SMCJ28A	SMCJ48A	SMCJ90A
C0	680μF/16V	680μF/25V	330μF/50V	330μF/100V
C1	4.7μF/50V			4.7μF/100V
LDM2	12μH			
C2	4.7μF/50V			4.7μF/100V
CY	1nF/3KV			
D1	RB160M-60/1A			
R	Follows: $R = \frac{V_C - V_D - 1.0}{I_C} - 300$			
Cd	47nF/100V			

- Note: 1. In Figure 1, part ① is EMS recommended external circuit, part ② is EMI recommended external circuit. Choose according to requirements;
 2. V_C is the voltage to GND from Ctrl, V_D is the forward conduction voltage drop of D1, I_C is the current through Ctrl pin which is normally 5-10mA, the external circuit of Ctrl is as shown in figure1-③;
 3. If there is no recommended parameters, the model no require the external component.

EMC RECOMMENDED CIRCUIT PCB LAYOUT

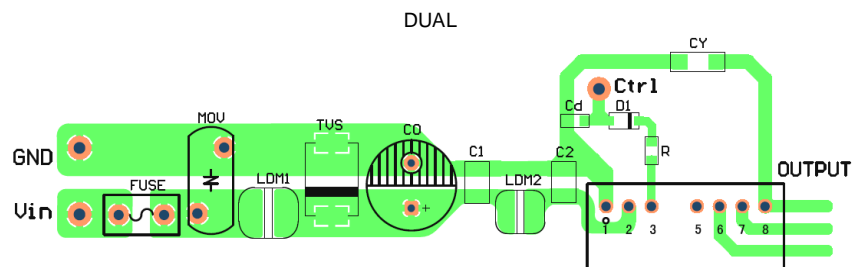

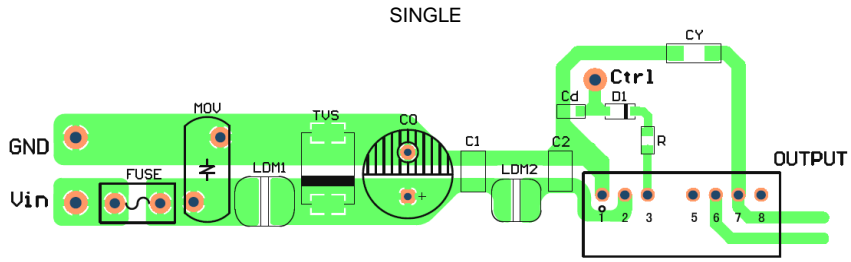

(Figure 2)

Note: The pad space between input and output GND (CY) must $\geq 2\text{mm}$.

EMC MODULE APPLICATION CIRCUIT

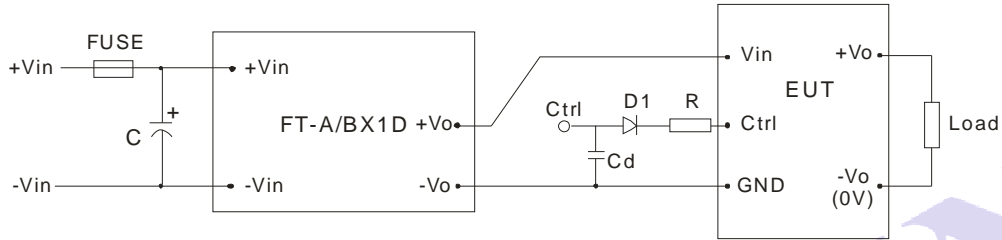

FT-A/BX1D is MORNSUN's EFT suppressor
 For Nominal Voltage $< 48\text{V}$, $C \geq 330\mu\text{F}/50\text{V}$
 For Nominal Voltage $= 48\text{V}$, $C \geq 330\mu\text{F}/100\text{V}$
 (Figure 3)

EMC MODULE RECOMMENDED CIRCUIT PCB LAYOUT

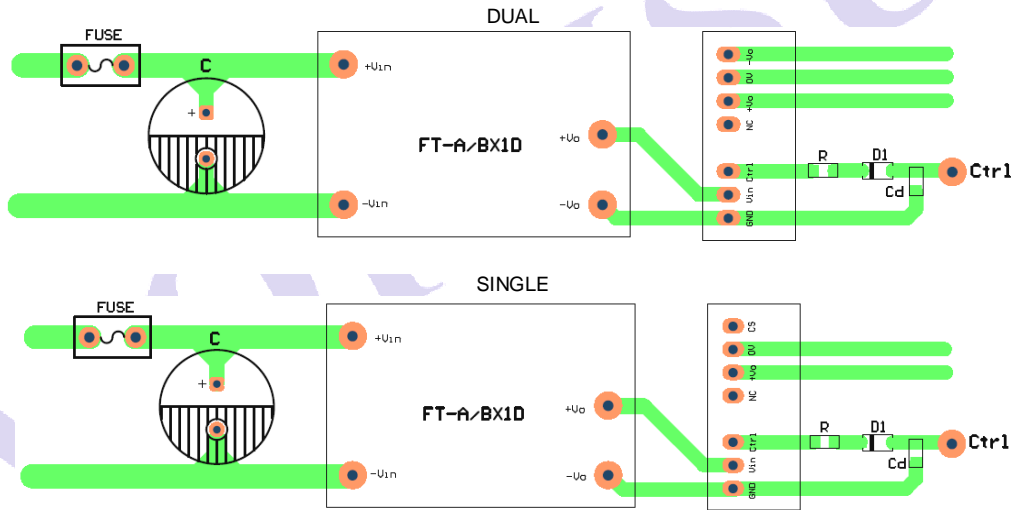

(Figure 4)

EMI TEST WAVEFORM (RECOMMENDED CIRCUIT REFER TO FIGURE 1-②)

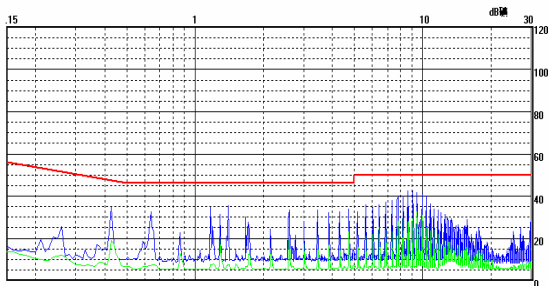

WRE2415S-3WR2 CE(Class B, Positive line)

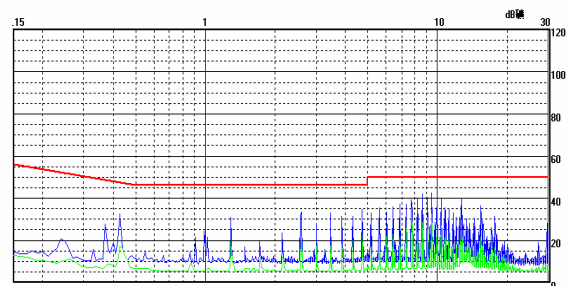

WRE2415S-3WR2 CE(Class B, Negative line)

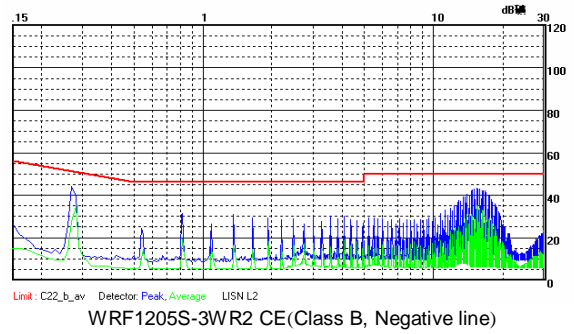
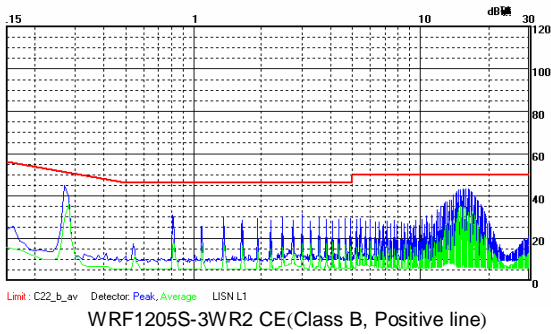

PRODUCT TYPICAL PERFORMANCE CURVE

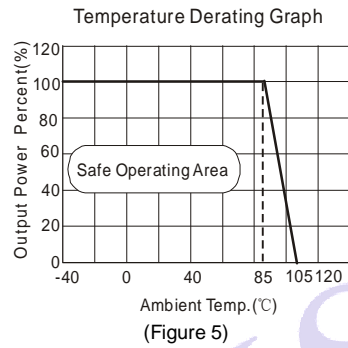

Efficiency VS Input Voltage curve (Full Load)

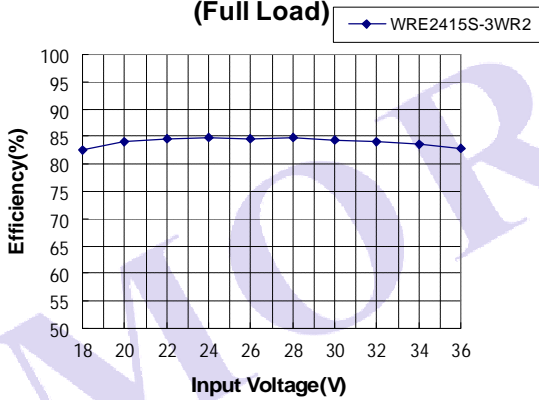

Efficiency VS Output Load curve (Vin=Vin-nominal)

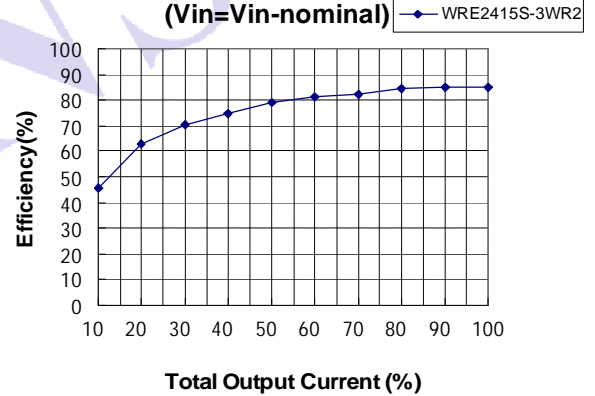

Efficiency VS Input Voltage curve (Full Load)

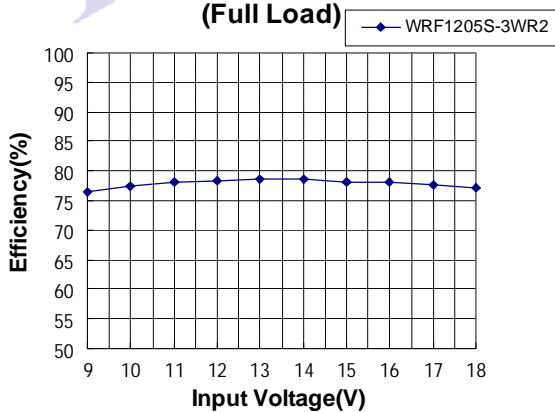

Efficiency VS Output Load curve (Vin=Vin-nominal)

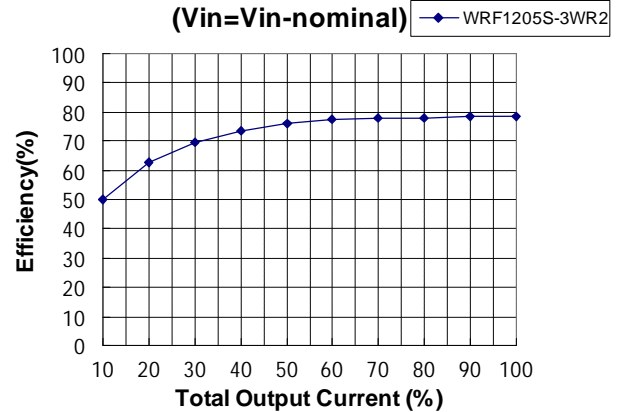

OUTLINE DIMENSIONS, RECOMMENDED FOOTPRINT & PACKAGING

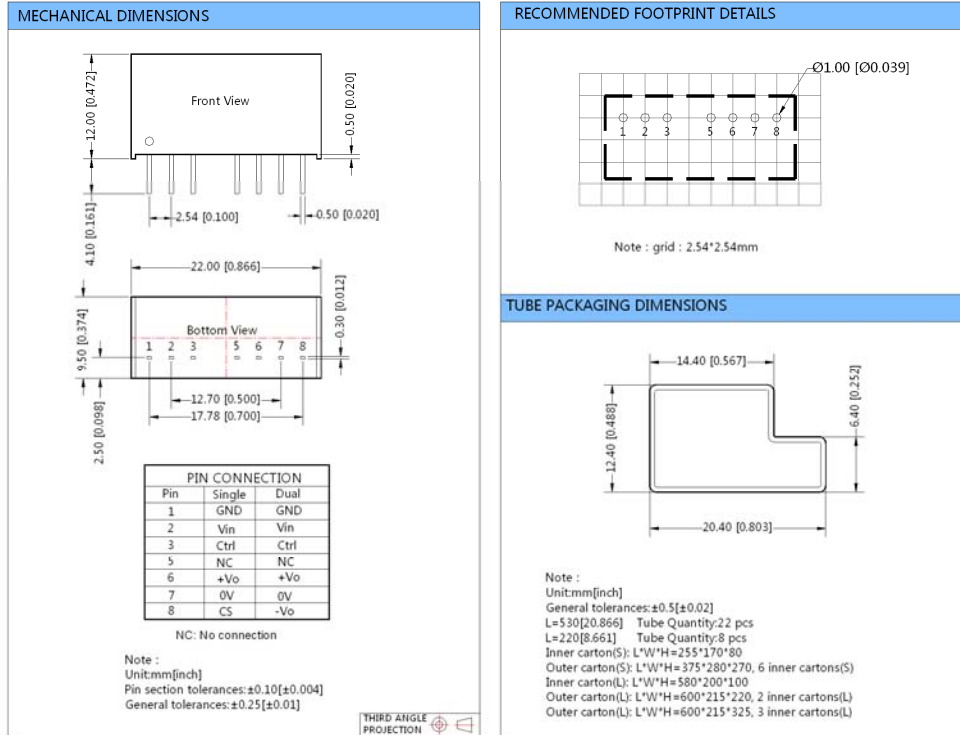

TEST CONFIGURATIONS

Input Reflected-Ripple Current Test Setup

Input reflected-ripple current is measured with an inductor L_{in} and Capacitor C_{in} to simulate the source impedance.

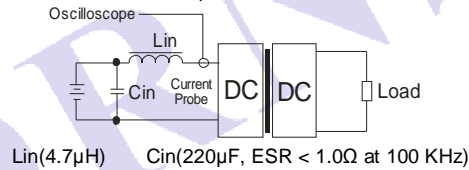

DESIGN CONSIDERATIONS

1) Requirement on output load

To ensure this module can operate efficiently and reliably, during operation, the minimum output load could not be less than 5% of the full load, otherwise output ripple may increase dramatically. If the actual output power is very small, please connect a resistor with proper resistance at the output end in parallel to increase the load, suppose to use the resistance of 5% rated power, or use our company's products with a lower rated output power.

2) Recommended circuit

All the WRE_S-3WR2 & WRF_S-3WR2 series have been tested according to the following recommended test circuit before leaving the factory (see Figure 6).

If you want to further decrease the input/output ripple, you can increase a capacitance-values properly or choose capacitors with low ESR. However, the capacitance of the output filter capacitor must be proper. If the capacitance is too big, a startup problem might arise. For every channel of output, provided the safe and reliable operation is ensured, the greatest capacitance of its filter capacitor must be less than the Max. Capacitive Load.

- General: C_{in1} : 5V&12V 100μF
- 24V&48V 10μF
- C_{in2} : 5V&12V 47μF
- 24V&48V 1μF
- Lin: 4.7μH~12μH
- Cs: 10μF~22μF
- Cout: 100μF(Typ.)
- Lout: 2.2μH~10μH
- Cd: 47nF/100V

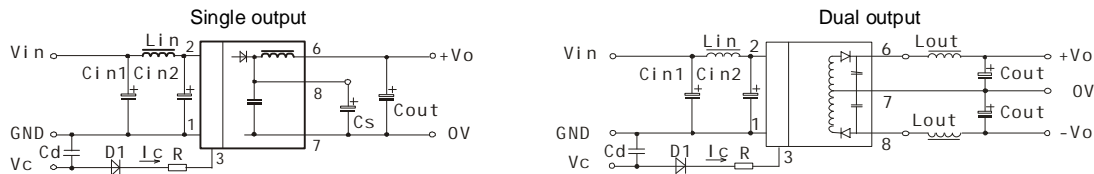

(Figure 6)

3) Ctrl Terminal

When open or high impedance, the converter works well; When this pin is 'high', the converter shut down. It should be note that the input current should be between 5-10mA, exceeding the maximum 20mA will cause permanent damage to the converter. The value of R can be derived as follows:

$$R = \frac{V_C - V_D - 1.0}{I_C} - 300$$

For Detailed parameter, please refer to "EMC RECOMMENDED CIRCUIT".

4) Input current

When it is used in unregulated power supply, be sure that the fluctuating range of the power supply and the rippled voltage do not exceed the module standard. Input current of power supply should afford the flash startup average current of this kind of DC/DC module (Figure 7).

General: Vin:5V Iave =1110mA
Vin:12V Iave =640mA
Vin:24V Iave =325mA
Vin:48V Iave =160mA

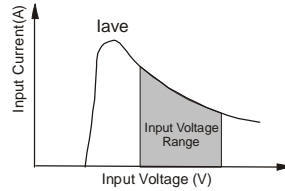

(Figure 7)

5) It is not recommended to increase the output power capability by connecting two or more converters in parallel. The product is not hot-swappable

Note:

1. Min. load shouldn't be less than 5%, otherwise ripple maybe increased dramatically. If the product operates under min. load, it may not be guaranteed to meet all specifications listed. Operation under minimum load will not damage the converter.
2. Recommended Dual output models unbalanced load is $\leq \pm 5\%$, if the product operates $> \pm 5\%$, it may not be guaranteed to meet all specifications listed. Please contact our technical support for more details.
3. Max. Capacitive Load is tested at input voltage range and full load.
4. All specifications measured at $T_a = 25^\circ\text{C}$, humidity $< 75\%$, nominal input voltage and rated output load unless otherwise specified.
5. In this datasheet, all test methods are based on our corporate standards.
6. All characteristics are for listed models, and non-standard models may perform differently. Please contact our technical support for more details.
7. Please contact our technical support for any specific requirement.
8. Specifications of this product are subject to changes without prior notice.

MORNSUN Science & Technology Co., Ltd.

Address: No. 5, Kehui St. 1, Kehui development center, Science Ave., Guangzhou Science City, Luogang district, Guangzhou, P.R.China.

Tel: 86-20-38601850

Fax: 86-20-38601272

E-mail: info@mornsun.cn

[Http://www.mornsun-power.com](http://www.mornsun-power.com)