



**DC COMPONENTS CO., LTD.**

RECTIFIER SPECIALISTS

SS12

THRU

SS18

**TECHNICAL SPECIFICATIONS OF SURFACE MOUNT SCHOTTKY BARRIER RECTIFIER**

VOLTAGE RANGE - 20 to 80 Volts

CURRENT - 1.0 Ampere

**FEATURES**

- \* Ideal for surface mounted applications
- \* Low leakage current
- \* Glass passivated junction

**MECHANICAL DATA**

- \* Case: Molded plastic
- \* Epoxy: UL 94V-0 rate flame retardant
- \* Terminals: Solder plated solderable per MIL-STD-750, Method 2026
- \* Polarity: As marked
- \* Mounting position: Any
- \* Weight: 0.064 gram

**MAXIMUM RATINGS AND ELECTRICAL CHARACTERISTICS**

Ratings at 25 °C ambient temperature unless otherwise specified.  
Single phase, half wave, 60 Hz, resistive or inductive load.  
For capacitive load, derate current by 20%.



SMA (DO-214AC)

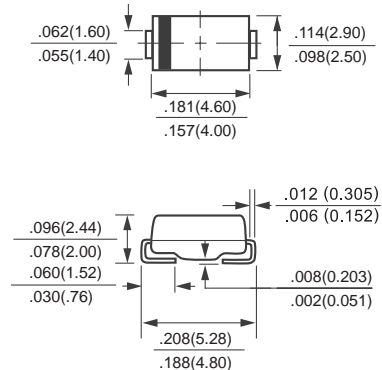

Dimensions in inches and (millimeters)

	SYMBOL	SS12	SS13	SS14	SS15	SS16	SS18	UNITS
Maximum Recurrent Peak Reverse Voltage	V <sub>RRM</sub>	20	30	40	50	60	80	Volts
Maximum RMS Voltage	V <sub>RMS</sub>	14	21	28	35	42	56	Volts
Maximum DC Blocking Voltage	V <sub>DC</sub>	20	30	40	50	60	80	Volts
Maximum Average Forward Rectified Current at Derating Lead Temperature	I <sub>O</sub>	1.0						Amps
Peak Forward Surge Current 8.3 ms single half sine-wave superimposed on rated load (JEDEC Method)	I <sub>FSM</sub>	30						Amps
Maximum Instantaneous Forward Voltage at 1.0A DC	V <sub>F</sub>	0.55		0.70		0.85		Volts
Maximum DC Reverse Current at Rated DC Blocking Voltage	I <sub>R</sub>	@ T <sub>A</sub> = 25 °C						mAmps
		@ T <sub>A</sub> = 100 °C						
Typical Thermal Resistance (Note 1)	R <sub>θJA</sub>	88						°C/W
Typical Junction Capacitance (Note 2)	C <sub>J</sub>	110						pF
Operating Temperature Range	T <sub>J</sub>	-65 to + 125						°C
Storage Temperature Range	T <sub>STG</sub>	-65 to + 150						°C

- NOTES : 1. Thermal Resistance (Junction to Ambient).  
 2. Measured at 1 MHz and applied reverse voltage of 4.0 volts.  
 3. P.C.B Mounted with 0.2X0.2\*(5.0X5.0mm<sup>2</sup>) copper pad area.

# RATING AND CHARACTERISTIC CURVES ( SS12 THRU SS18 )

FIG. 1 - TYPICAL FORWARD CURRENT DERATING CURVE

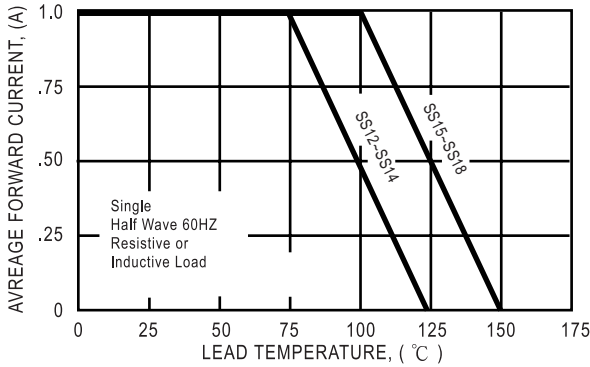

FIG. 2 - TYPICAL INSTANTANEOUS FORWARD CHARACTERISTICS

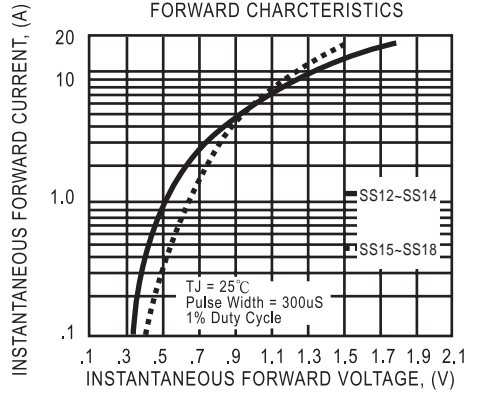

FIG. 3A - TYPICAL REVERSE CHARACTERISTICS

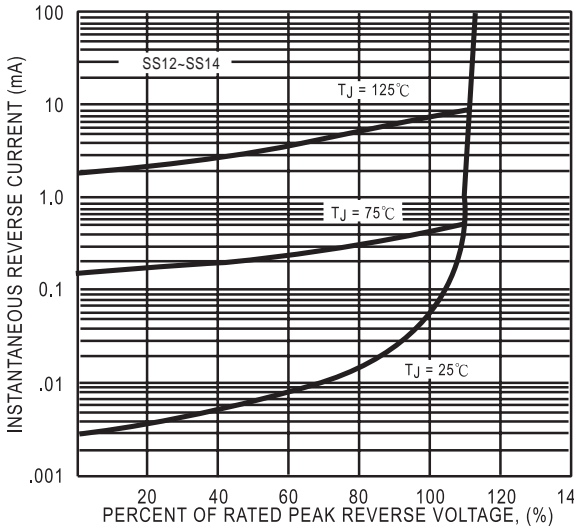

FIG. 3 - TYPICAL REVERSE CHARACTERISTICS

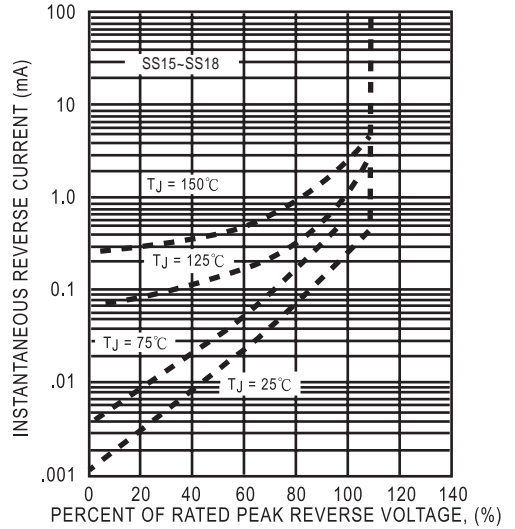

FIG. 4 - TYPICAL JUNCTION CAPACITANCE

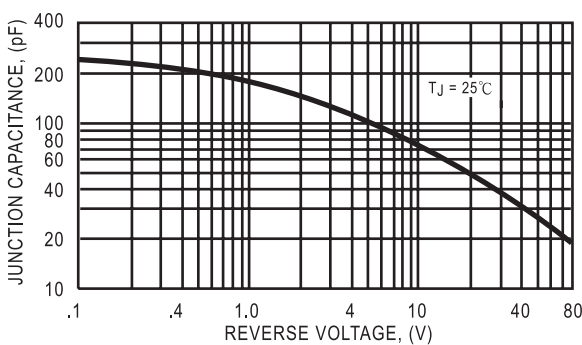
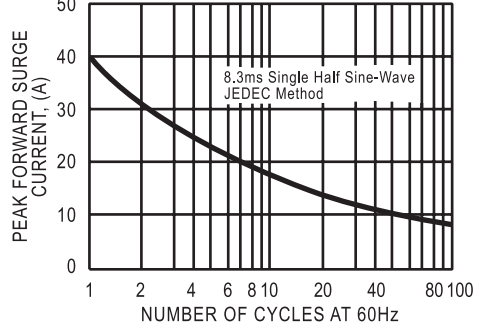

FIG. 5 - MAXIMUM NON-REPETITIVE FORWARD SURGE CURRENT



DC COMPONENTS CO., LTD.