

# High Power Infrared Emitter (850 nm) Version 1.5

---

## SFH 4350



### Features:

- High Power Infrared LED
- Emission angle  $\pm 13^\circ$
- Very high radiant intensity
- Short switching times
- UL version available ( ordering code & test conditions on request)

### Applications

- Infrared Illumination for cameras
- Data transmission
- Sensor technology
- Smoke detectors

### Notes

Depending on the mode of operation, these devices emit highly concentrated non visible infrared light which can be hazardous to the human eye. Products which incorporate these devices have to follow the safety precautions given in IEC 60825-1 and IEC 62471.

### Ordering Information

Type:	Radiant Intensity $I_e$ [mW/sr] $I_F = 100 \text{ mA}, t_p = 20 \text{ ms}$	Ordering Code
SFH 4350	200 ( $\geq 63$ )	Q65110A2091
SFH 4350-AWBW	100 ... 320	Q65111A2797

Note: Measured at a solid angle of  $\Omega = 0.01 \text{ sr}$

**Maximum Ratings** ( $T_A = 25\text{ °C}$ )

Parameter	Symbol	Values	Unit
Operation and storage temperature range	$T_{op}; T_{stg}$	-40 ... 100	°C
Reverse voltage	$V_R$	5	V
Forward current	$I_F$	100	mA
Surge current ( $t_p \leq 100\ \mu\text{s}$ , $D = 0$ )	$I_{FSM}$	1	A
Power consumption	$P_{tot}$	180	mW
ESD withstand voltage (acc. to ANSI/ ESDA/ JEDEC JS-001 - HBM)	$V_{ESD}$	2	kV
Thermal resistance junction - ambient <sup>1) page 8</sup>	$R_{thJA}$	450	K / W

**Characteristics** ( $T_A = 25\text{ °C}$ )

Parameter		Symbol	Values	Unit
Peak wavelength ( $I_F = 100\text{ mA}$ , $t_p = 20\text{ ms}$ )	(typ)	$\lambda_{peak}$	860	nm
Centroid wavelength ( $I_F = 100\text{ mA}$ , $t_p = 20\text{ ms}$ )	(typ)	$\lambda_{centroid}$	850	nm
Spectral bandwidth at 50% of $I_{max}$ ( $I_F = 100\text{ mA}$ , $t_p = 20\text{ ms}$ )	(typ)	$\Delta\lambda$	30	nm
Half angle	(typ)	$\varphi$	$\pm 13$	°
Dimensions of active chip area	(typ)	L x W	0.3 x 0.3	mm x mm
Rise and fall time of $I_e$ ( 10% and 90% of $I_{e,max}$ ) ( $I_F = 100\text{ mA}$ , $R_L = 50\ \Omega$ )	(typ)	$t_r, t_f$	12	ns
Forward voltage ( $I_F = 100\text{ mA}$ , $t_p = 20\text{ ms}$ )	(typ (max))	$V_F$	1.5 ( $\leq 1.8$ )	V
Forward voltage ( $I_F = 1\text{ A}$ , $t_p = 100\ \mu\text{s}$ )	(typ (max))	$V_F$	2.4 ( $\leq 3$ )	V
Reverse current ( $V_R = 5\text{ V}$ )		$I_R$	not designed for reverse operation	$\mu\text{A}$
Total radiant flux ( $I_F = 100\text{ mA}$ , $t_p = 20\text{ ms}$ )	(typ)	$\Phi_e$	70	mW
Temperature coefficient of $I_e$ or $\Phi_e$ ( $I_F = 100\text{ mA}$ , $t_p = 20\text{ ms}$ )	(typ)	$TC_I$	-0.5	% / K
Temperature coefficient of $V_F$ ( $I_F = 100\text{ mA}$ , $t_p = 20\text{ ms}$ )	(typ)	$TC_V$	-0.7	mV / K
Temperature coefficient of wavelength ( $I_F = 100\text{ mA}$ , $t_p = 20\text{ ms}$ )	(typ)	$TC_\lambda$	0.3	nm / K

Grouping ( $T_A = 25\text{ }^\circ\text{C}$ )

Group	Min Radiant Intensity $I_F = 100\text{ mA}, t_p = 20\text{ ms}$ $I_{e, \text{min}}$ [mW / sr]	Max Radiant Intensity $I_F = 100\text{ mA}, t_p = 20\text{ ms}$ $I_{e, \text{max}}$ [mW / sr]	Typ Radiant Intensity $I_F = 1\text{ A}, t_p = 25\text{ }\mu\text{s}$ $I_{e, \text{typ}}$ [mW / sr]
SFH 4350-V	63	125	750
SFH 4350-AW	100	200	1200
SFH 4350-BW	160	320	1900
SFH 4350-CW	250	500	3000

Note: measured at a solid angle of  $\Omega = 0.01\text{ sr}$   
Only one group in one packing unit (variation lower 2:1).

Relative Spectral Emission <sup>2) page 8</sup>

$I_{\text{rel}} = f(\lambda), T_A = 25\text{ }^\circ\text{C}$

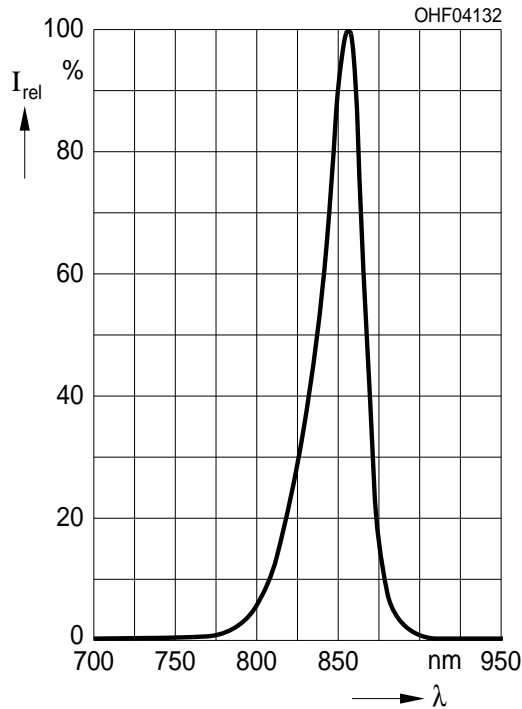

Radiant Intensity <sup>2) page 8</sup>

$I_e / I_e(100\text{ mA}) = f(I_F), \text{ single pulse}, t_p = 25\text{ }\mu\text{s}, T_A = 25\text{ }^\circ\text{C}$

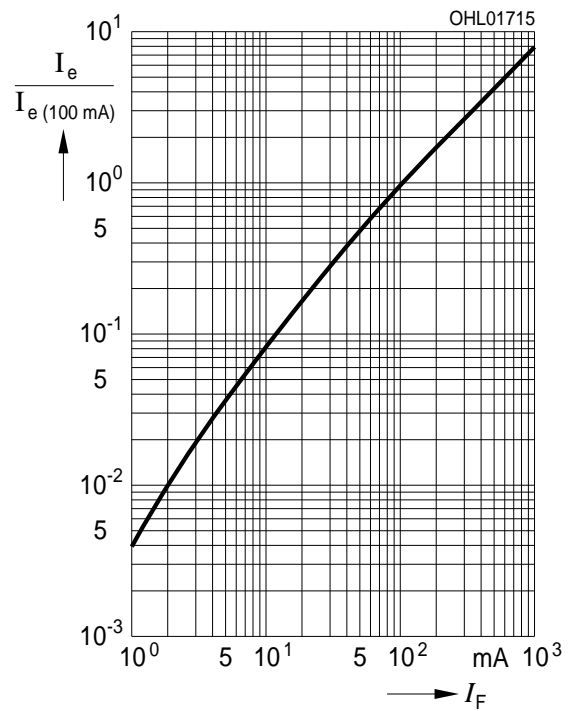

**Max. Permissible Forward Current**

$I_{F, \max} = f(T_A), R_{thJA} = 450 \text{ K / W}$

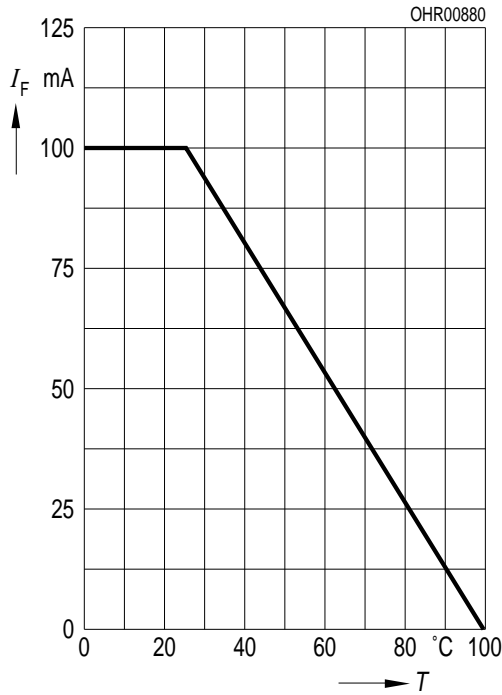

**Forward Current** <sup>2) page 8</sup>

$I_F = f(V_F), \text{ single pulse, } t_p = 100 \mu\text{s}, T_A = 25^\circ\text{C}$

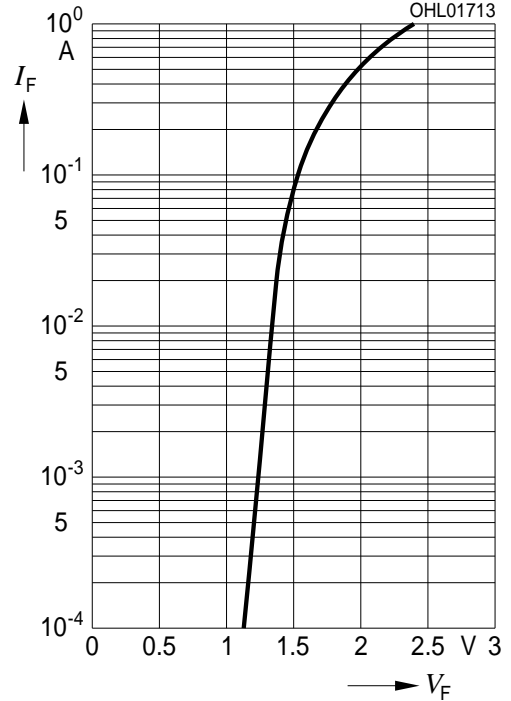

**Permissible Pulse Handling Capability**

$I_F = f(t_p), T_A = 25^\circ\text{C}, \text{ duty cycle } D = \text{parameter}$

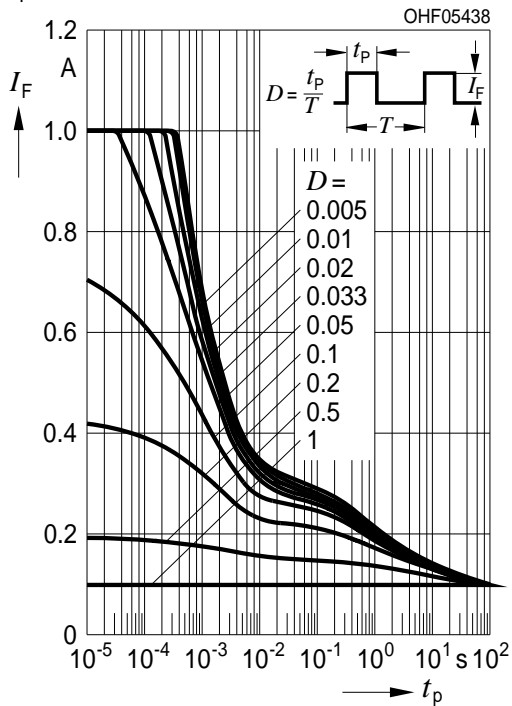

**Permissible Pulse Handling Capability**

$I_F = f(t_p), T_A = 85^\circ\text{C}, \text{ duty cycle } D = \text{parameter}$

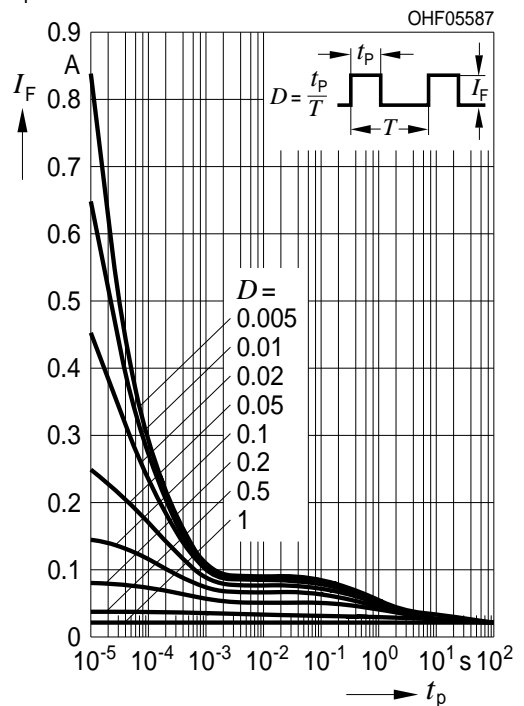

**Radiation Characteristics** <sup>2) page 8</sup>

$I_{rel} = f(\phi), T_A = 25^\circ\text{C}$

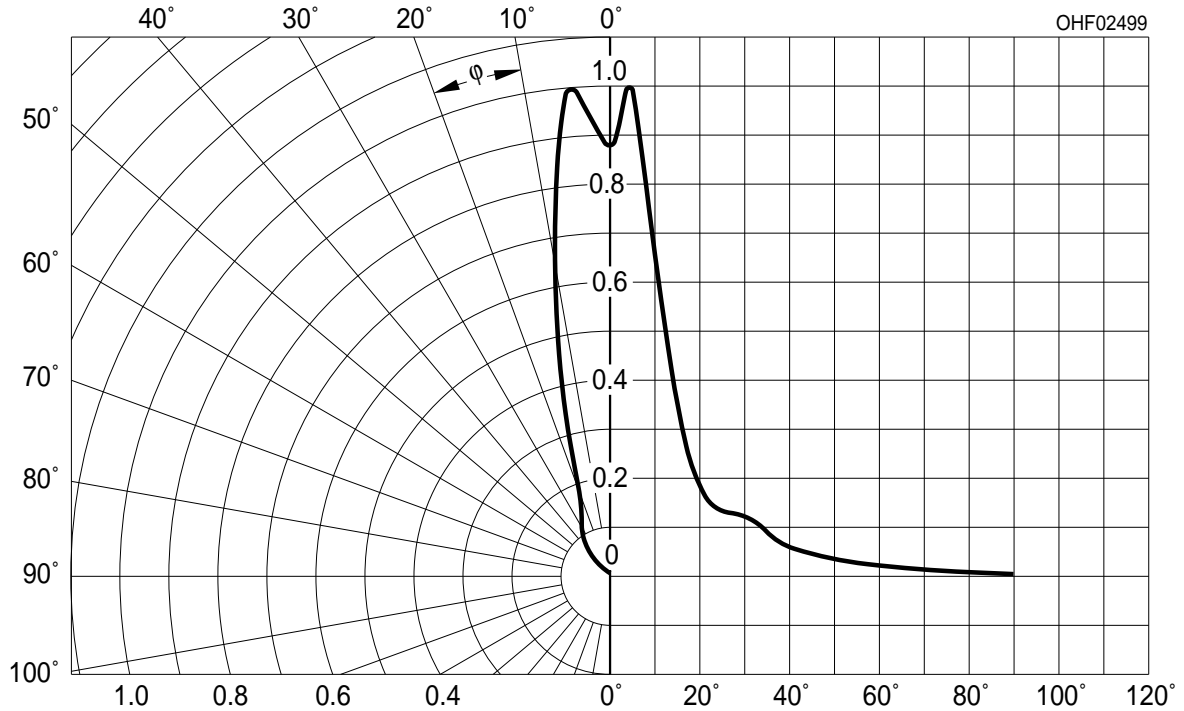

**Package Outline**

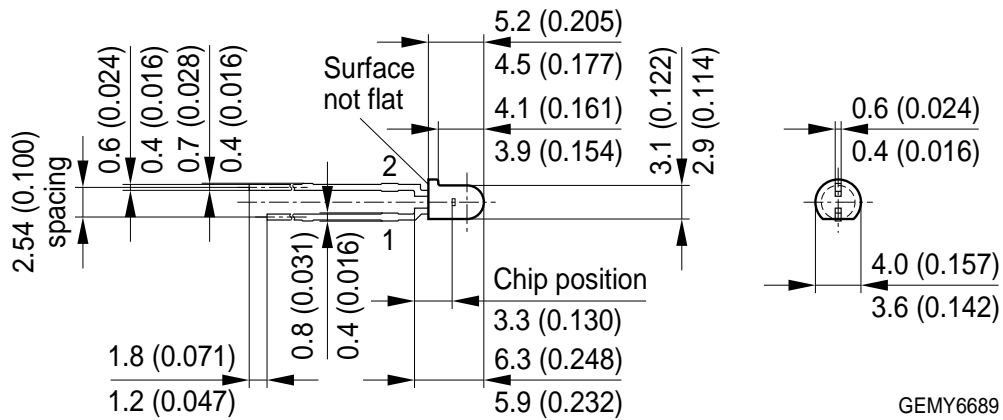

GEMY6689

*Dimensions in mm (inch).*

**Pinning**

Pin	Description
1	anode
2	cathode

**Package**

3mm Radial (T 1), Epoxy

**Approximate Weight:**

0.2 g

**Note**

Packing information is available on the internet (online product catalog).

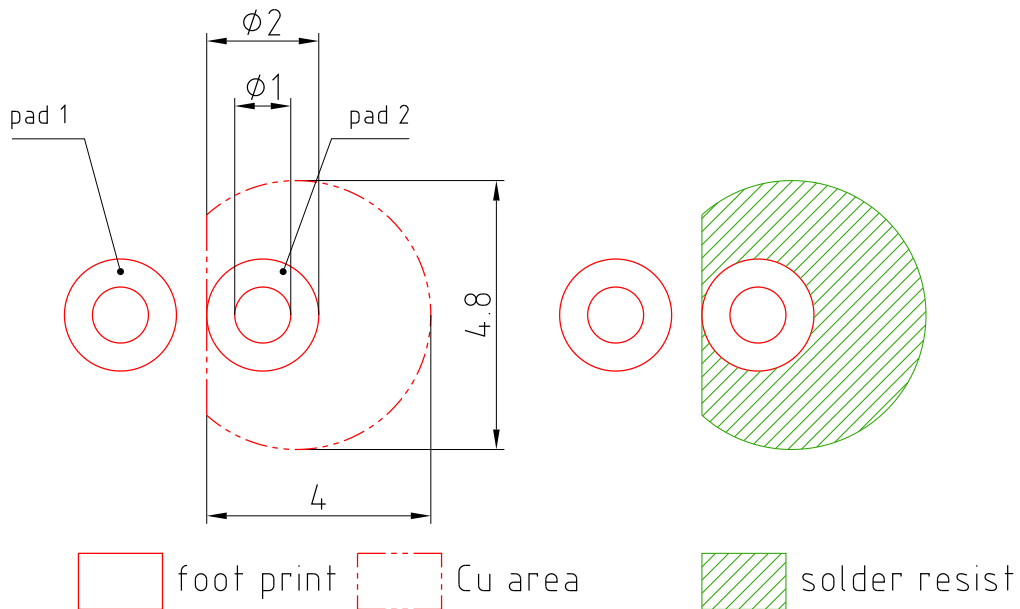
**Recommended Solder Pad**

E062.3010.188-01

Dimensions in mm.

**Note:**

pad 1: cathode

**TTW Soldering**

IEC-61760-1 TTW

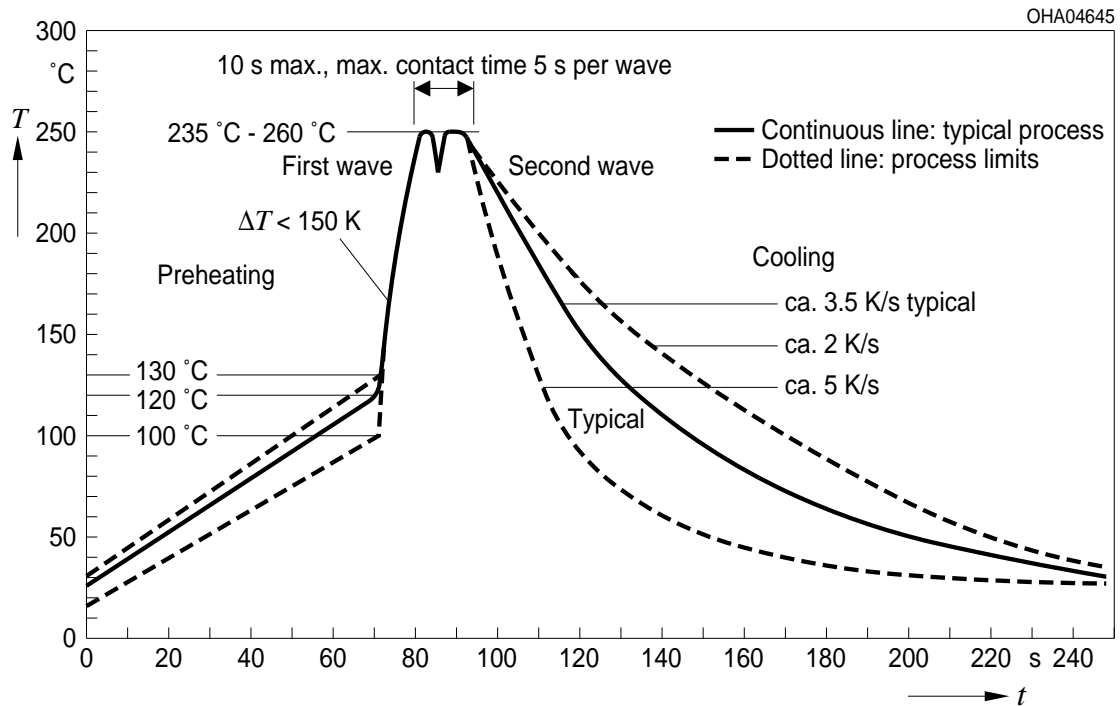
**Disclaimer**

Language english will prevail in case of any discrepancies or deviations between the two language wordings.

**Attention please!**

The information describes the type of component and shall not be considered as assured characteristics.

Terms of delivery and rights to change design reserved. Due to technical requirements components may contain dangerous substances.

For information on the types in question please contact our Sales Organization.

If printed or downloaded, please find the latest version in the Internet.

**Packing**

Please use the recycling operators known to you. We can also help you – get in touch with your nearest sales office. By agreement we will take packing material back, if it is sorted. You must bear the costs of transport. For packing material that is returned to us unsorted or which we are not obliged to accept, we shall have to invoice you for any costs incurred.

**Components used in life-support devices or systems must be expressly authorized for such purpose!**

Critical components\* may only be used in life-support devices\*\* or systems with the express written approval of OSRAM OS.

\*) A critical component is a component used in a life-support device or system whose failure can reasonably be expected to cause the failure of that life-support device or system, or to affect its safety or the effectiveness of that device or system.

\*\*) Life support devices or systems are intended (a) to be implanted in the human body, or (b) to support and/or maintain and sustain human life. If they fail, it is reasonable to assume that the health and the life of the user may be endangered.

**Glossary**

- 1) **Thermal resistance:** junction -ambient, mounted on PC-board (FR4), pads size 16 mm<sup>2</sup> each
- 2) **Typical Values:** Due to the special conditions of the manufacturing processes of LED, the typical data or calculated correlations of technical parameters can only reflect statistical figures. These do not necessarily correspond to the actual parameters of each single product, which could differ from the typical data and calculated correlations or the typical characteristic line. If requested, e.g. because of technical improvements, these typ. data will be changed without any further notice.



**Published by OSRAM Opto Semiconductors GmbH**  
**Leibnizstraße 4, D-93055 Regensburg**  
**www.osram-os.com © All Rights Reserved.**

EU RoHS and China RoHS compliant product



此产品符合欧盟 RoHS 指令的要求；  
按照中国的相关法规和标准，不含有毒有害物质或元素。