

TOSHIBA Photocoupler GaAs IRed & Photo-Transistor

## 4N25(Short),4N25A(Short),4N26(Short),4N27(Short),4N28(Short)

- AC Line / Digital Logic Isolator.
- Digital Logic / Digital Logic Isolator.
- Telephone Line Receiver.
- Twisted Pair Line Receiver
- High Frequency Power Supply Feedback Control.
- Relay Contact Monitor.

The TOSHIBA 4N25 (Short) through 4N28 (Short) consists of a gallium arsenide infrared emitting diode coupled with a silicon phototransistor in a dual in-line package.

- Switching speeds: 3μs (typ.)
- DC current transfer ratio: 100% (typ.)
- Isolation resistance: 10<sup>11</sup>Ω (min.)
- Isolation voltage: 2500Vrms (min.)
- UL recognized: UL1577, file No. E67349

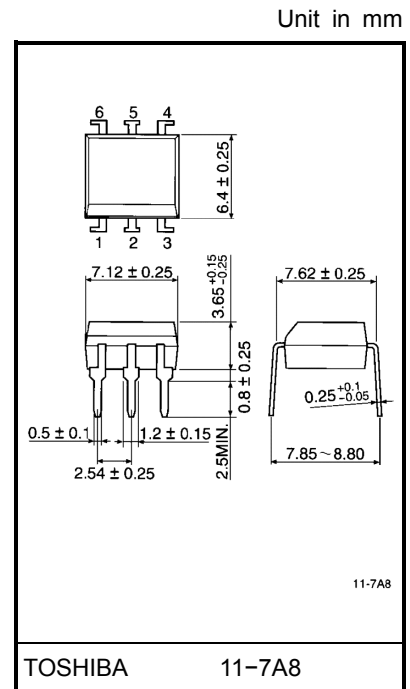

Weight: 0.4g

### Pin Configurations(top view)

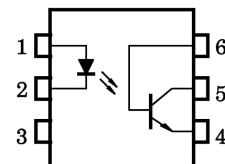

- 1 : ANODE
- 2 : CATHODE
- 3 : N.C.
- 4 : EMITTER
- 5 : COLLECTOR
- 6 : BASE

## Maximum Ratings (Ta = 25°C)

Characteristic		Symbol	Rating	Unit
LED	Forward current (continuous)	$I_F$	80	mA
	Forward current derating	$\Delta I_F / ^\circ\text{C}$	1.07 (*)	mA / °C
	Peak forward current (Note 1)	$I_{PF}$	3	A
	Power dissipation	$P_D$	150	mW
	Power dissipation derating	$\Delta P_D / ^\circ\text{C}$	2.0 (*)	mW / °C
	Reverse voltage	$V_R$	3	V
Detector	Collector-emitter voltage	$BV_{CEO}$	30	V
	Collector-base voltage	$BV_{CBO}$	70	V
	Emitter-collector voltage	$BV_{ECO}$	7	V
	Collector current (continuous)	$I_C$	100	mA
	Power dissipation	$P_C$	150	mW
	Power dissipation derating	$\Delta P_C / ^\circ\text{C}$	2.0 (*)	mW / °C
Coupled	Storage temperature range	$T_{stg}$	-55~150	°C
	Operating temperature range	$T_{opr}$	-55~100	°C
	Lead soldering temperature (10s)	$T_{sol}$	260	°C
	Total package power dissipation	$P_T$	250	mW
	Total package power dissipation derating	$\Delta P_T / ^\circ\text{C}$	3.3 (*)	mW / °C

(Note 1) Pulse width 300μs, 2% duty cycle.

(\*) Above 25°C ambient.

## Electrical Characteristics (Ta = 25°C)

Characteristic		Symbol	Test Condition	Min.	Typ.	Max.	Unit	
LED	Forward voltage	$V_F$	$I_F = 10 \text{ mA}$	—	1.15	1.5	V	
	Reverse current	$I_R$	$V_R = 3 \text{ V}$	—	—	100	$\mu\text{A}$	
	Capacitance	$C_D$	$V = 0, f = 1 \text{ MHz}$	—	30	—	pF	
Detector	DC forward current gain	$h_{FE}$	$V_{CE} = 5 \text{ V}, I_C = 500 \mu\text{A}$	—	200	—	—	
	Collector-emitter breakdown voltage	$V_{(BR) CEO}$	$I_C = 1 \text{ mA}, I_F = 0$	30	—	—	V	
	Collector-base breakdown voltage	$V_{(BR) CBO}$	$I_C = 100 \mu\text{A}$	70	—	—	V	
	Emitter-collector breakdown voltage	$V_{(BR) ECO}$	$I_E = 100 \mu\text{A}$	7	—	—	V	
	Collector dark current	$I_{CEO}$	$V_{CE} = 10 \text{ V}$	—	1	50	nA	
	Collector dark current	$I_{CBO}$	$V_{CB} = 10 \text{ V}$	—	0.1	20	nA	
	Collector-emitter capacitance	$C_{CE}$	$V = 0, f = 1 \text{ MHz}$	—	10	—	pF	
	Coupled	Current transfer ratio	$I_C / I_F$	$I_F = 10 \text{ mA}, V_{CE} = 10 \text{ V}$	20	100	—	%
Collector-emitter saturation voltage		$V_{CE (sat)}$	$I_F = 50 \text{ mA}, I_C = 2 \text{ mA}$	—	0.1	0.5	V	
Capacitance input to output		$C_S$	$V_S = 0, f = 1 \text{ MHz}$	—	0.8	—	pF	
Isolation resistance		$R_S$	$V_S = 500 \text{ V}, \text{R.H.} \leq 60 \%$	$10^{11}$	—	—	$\Omega$	
Isolation voltage			$BV_S$	AC, 1 minute	2500	—	—	Vrms
			$BV_S (*)$	AC, peak	2500	—	—	Vpk
					1500	—	—	
					500	—	—	
				AC, 1 second	1775	—	—	Vrms
Rise / fall time		$t_r / t_f$	$V_{CE} = 10 \text{ V}, I_C = 2 \text{ mA}$ $R_L = 100 \Omega$	—	2	—	$\mu\text{s}$	
Rise / fall time	$t_r / t_f$	$V_{CB} = 10 \text{ V}, I_{CB} = 50 \mu\text{A}$ $R_L = 100 \Omega$	—	200	—	ns		

(\*) JEDEC registered minimum  $BV_S$ , however, TOSHIBA specifies a minimum  $BV_S$  of 2500 Vrms, 1 minute.

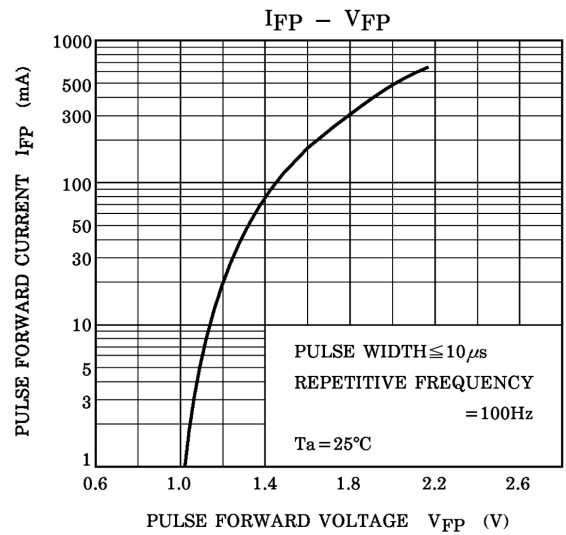
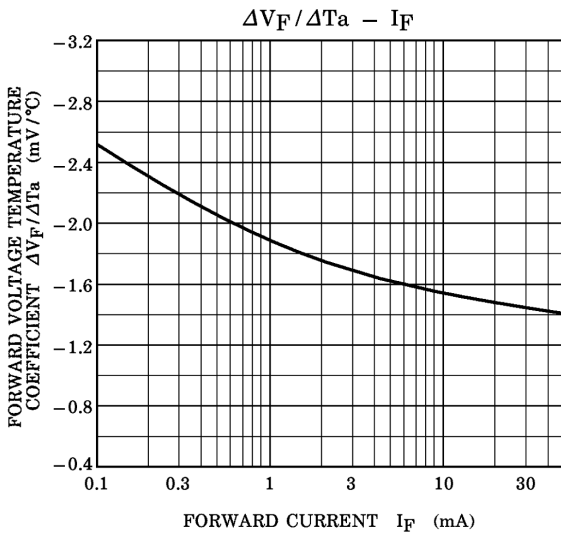
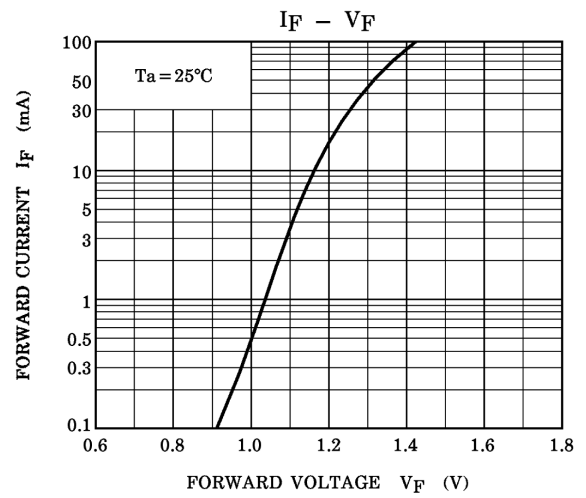
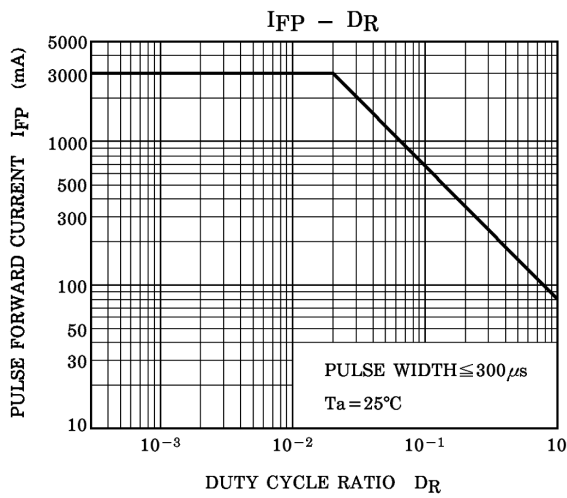
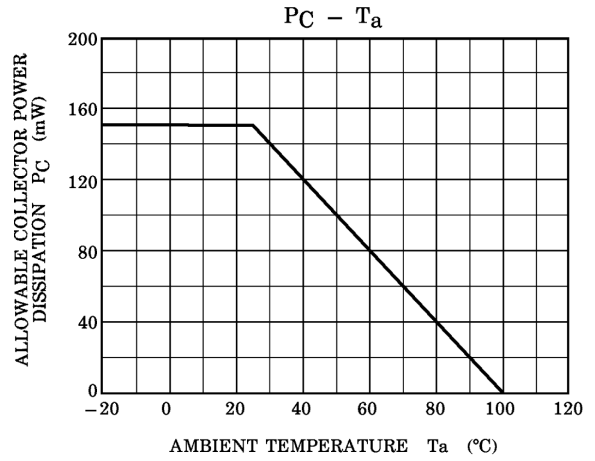
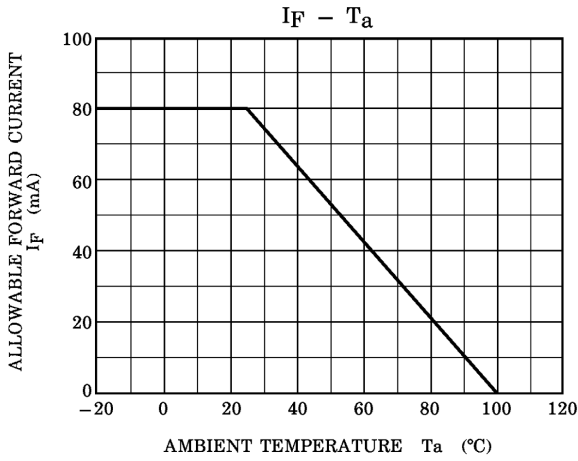

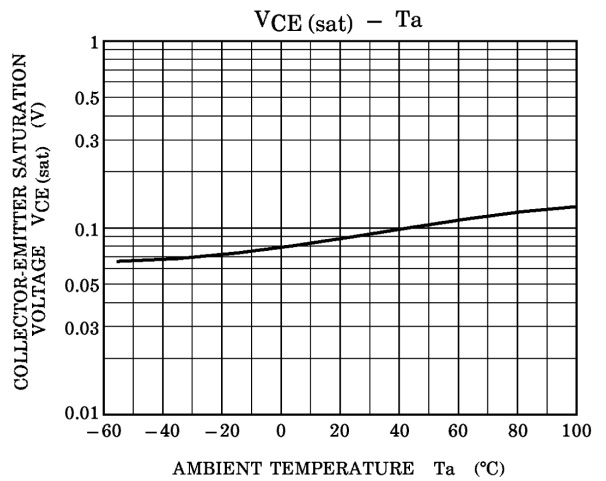
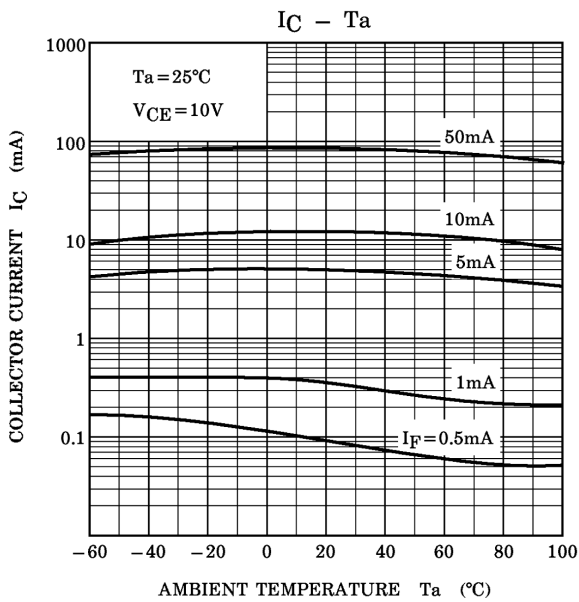
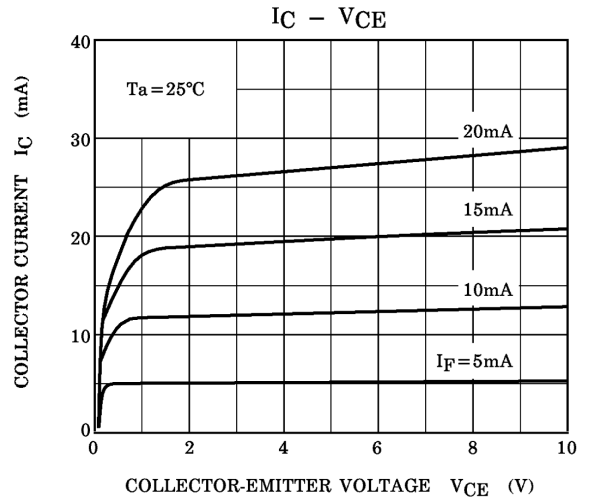
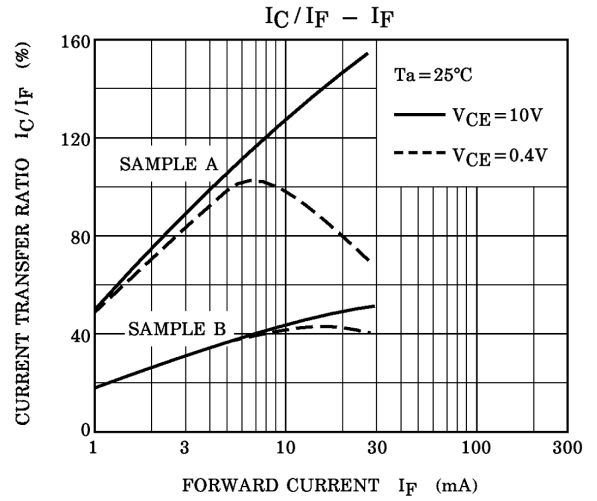
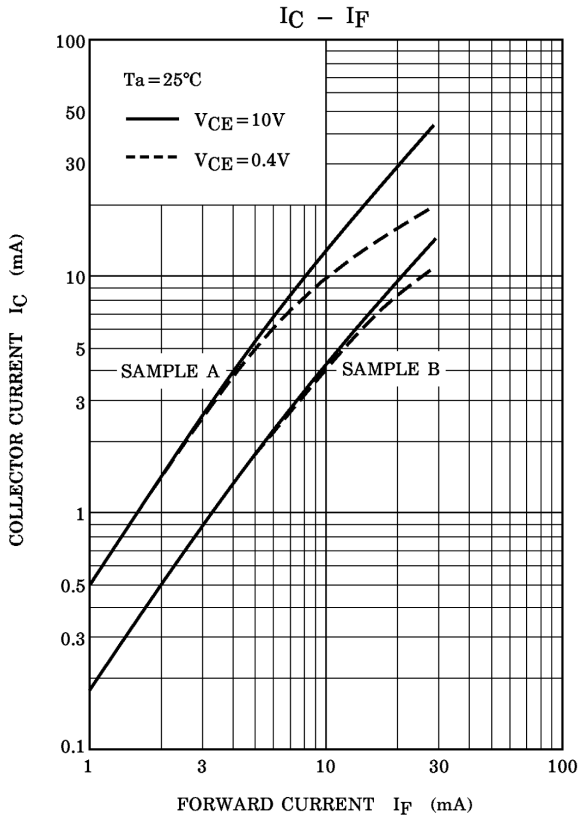

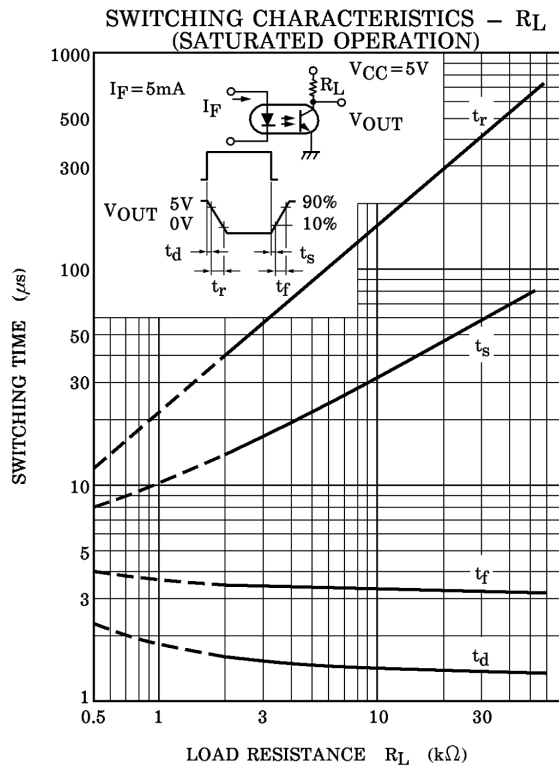
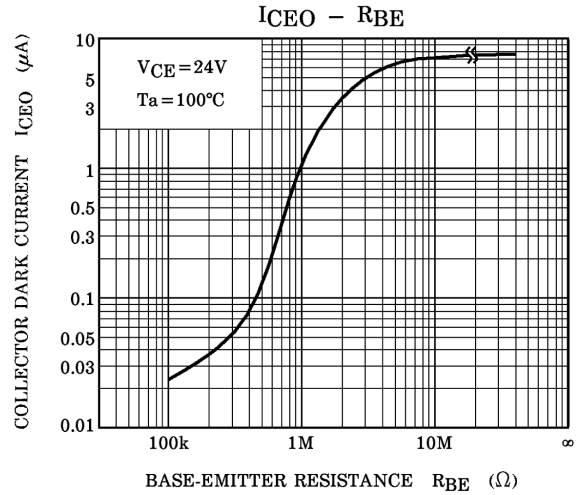
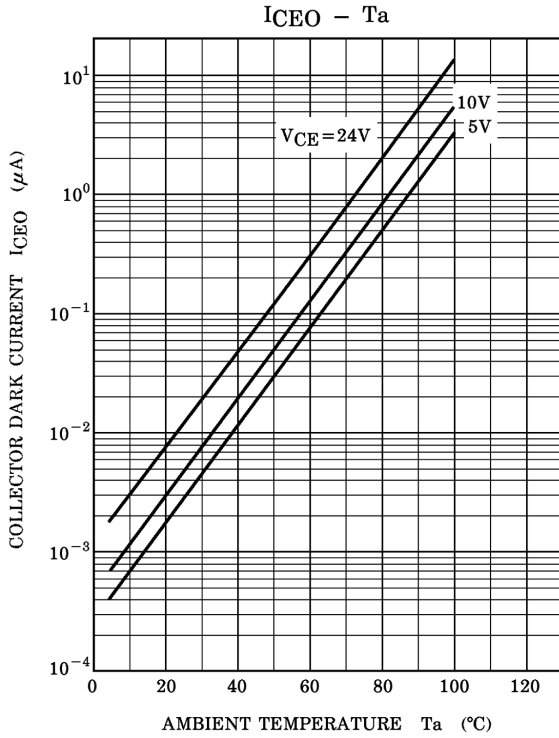

**SWITCHING CHARACTERISTICS -  $R_{BE}$  (SATURATED OPERATION)**

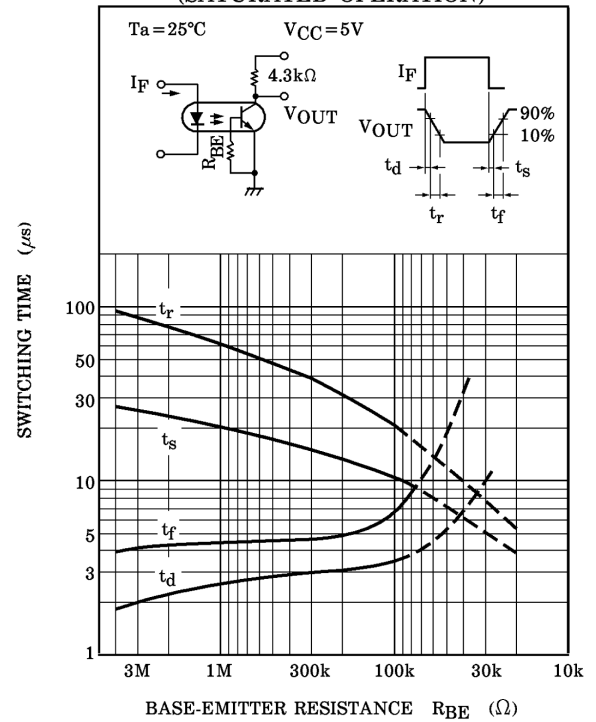

**RESTRICTIONS ON PRODUCT USE**

000707EBC

- TOSHIBA is continually working to improve the quality and reliability of its products. Nevertheless, semiconductor devices in general can malfunction or fail due to their inherent electrical sensitivity and vulnerability to physical stress. It is the responsibility of the buyer, when utilizing TOSHIBA products, to comply with the standards of safety in making a safe design for the entire system, and to avoid situations in which a malfunction or failure of such TOSHIBA products could cause loss of human life, bodily injury or damage to property.  
In developing your designs, please ensure that TOSHIBA products are used within specified operating ranges as set forth in the most recent TOSHIBA products specifications. Also, please keep in mind the precautions and conditions set forth in the "Handling Guide for Semiconductor Devices," or "TOSHIBA Semiconductor Reliability Handbook" etc..
- The TOSHIBA products listed in this document are intended for usage in general electronics applications (computer, personal equipment, office equipment, measuring equipment, industrial robotics, domestic appliances, etc.). These TOSHIBA products are neither intended nor warranted for usage in equipment that requires extraordinarily high quality and/or reliability or a malfunction or failure of which may cause loss of human life or bodily injury ("Unintended Usage"). Unintended Usage include atomic energy control instruments, airplane or spaceship instruments, transportation instruments, traffic signal instruments, combustion control instruments, medical instruments, all types of safety devices, etc.. Unintended Usage of TOSHIBA products listed in this document shall be made at the customer's own risk.
- Gallium arsenide (GaAs) is a substance used in the products described in this document. GaAs dust and fumes are toxic. Do not break, cut or pulverize the product, or use chemicals to dissolve them. When disposing of the products, follow the appropriate regulations. Do not dispose of the products with other industrial waste or with domestic garbage.
- The products described in this document are subject to the foreign exchange and foreign trade laws.
- The information contained herein is presented only as a guide for the applications of our products. No responsibility is assumed by TOSHIBA CORPORATION for any infringements of intellectual property or other rights of the third parties which may result from its use. No license is granted by implication or otherwise under any intellectual property or other rights of TOSHIBA CORPORATION or others.
- The information contained herein is subject to change without notice.