

# MINIATURE RELAY

## 2 POLES - 1 to 2 A (For Signal Switching)

### NA Series

#### ■ FEATURES

- Slim type relay for high density mounting
  - Conforms to Telcordia specification and FCC Part 68
    - Dielectric strength 1,500 VAC between coil and contacts
    - Surge strength 2,500 V between coil and contacts (at 2 × 10 s surge wave)
  - UL, CSA recognized
  - High sensitivity and low consumption power
  - High reliability - bifurcated contacts
  - DIL pitch terminals
  - Plastic sealed type
  - RoHS compliant.
- Please see page 8 for more information



#### ■ PARTNUMBER INFORMATION

[Example]     NA   L   -   D   12   W   -   K  
                   (a)   (b)   (\*)   (c)   (d)   (e)   (f)

(a)	Relay type	NA : NA Series
(b)	Coil type	Nil : Standard type L : Latching type
(c)	Number of coil	Nil : Single winding type D : Double winding type
(d)	Coil rated voltage	12 : 1.5...48VDC Coil rating table at page 3
(e)	Contact style	W : Bifurcated type
(f)	Enclosure	K : Plastic sealed

Note: Actual marking omits the hyphen (-) of (\*).

# NA SERIES

## ■ SPECIFICATION

Item			Standard type	Single winding latching type	Double winding latching type
			NA - ( ) W - K	NAL - ( ) W - K	NAL-D ( ) W - K
Contact Data	Configuration		2 form C (DPDT)		
	Construction		Bifurcated		
	Material		Gold overlay silver alloy (AgPd)		
	Resistance (Initial)		Max. 50 mΩ at 1 A, 6 VDC		
	Contact rating (resistive)		0.5A, 125VAC or 1A, 30VDC		
	Max. carrying current		2A		
	Max. switching voltage		250VAC / 220VDC		
	Max. switching power		62.5 AV / 30W		
	Max. switching current		2A		
	Min. switching load *		0.01 mA, 10 mVDC		
	Capacitance		Approx. 0.5 pF (open contacts, adjacent contacts) Approx. 1.0 pF (between coil and contacts)		
Life	Mechanical		Min. 100 x 10 <sup>6</sup> operations	Min. 10 x 10 <sup>6</sup> operations	
	Electrical		Min. 200 x 10 <sup>3</sup> operations (0.5A, 125VAC), Min. 500 x 10 <sup>3</sup> operations (1A, 30VDC)		
Coil Data	Rated power		140 - 300 mW	100 - 150 mW	200 - 300 mW
	Operate power		80 - 70 mW	60 - 85 mW	115 - 170 mW
	Operating temperature range		-40 °C to +85 °C (no frost)		
Timing Data	Operate (at nominal voltage)		Max. 6 ms	Max. 6 ms (set)	
	Release (at nominal voltage)		Max. 4 ms	Max. 6 ms (reset)	
Insulation	Resistance (Initial)		Min. 1,000MΩ at 500VDC		
	Dielectric strength	Open contacts / adjacent contacts	1,000VAC (50/60Hz) 1min		
		Contacts to coil	1,500VAC (50/60Hz) 1min.	1,000VAC (50/60Hz) 1min	
	Surge strength	Open contacts / adjacent contacts	1,500V / 10 x 700μs standard wave		
Coil to contacts		2,500V / 2 x 10μs standard wave	1,500V / 10 x 160μs standard wave		
Other	Vibration resistance	Misoperation	10 to 55Hz double amplitude 3.3mm		
		Endurance	10 to 55Hz double amplitude 5.0mm		
	Shock	Misoperation	500m/s <sup>2</sup> (11 ± 1ms)		
		Endurance	1,000m/s <sup>2</sup> (6 ± 1ms)		
	Weight	Approximately 1.5 g			

\* Minimum switching loads mentioned above are reference values. Please perform the confirmation test with actual load before production since reference values may vary according to switching frequencies, environmental conditions and expected reliability levels.

# NA SERIES

## ■ COIL RATING

Standard type

Coil Code	Rated Coil Voltage (VDC)	Coil Resistance +/- 10% (Ohm)	Must Operate Voltage (VDC) *	Must Release-Voltage (VDC) *	Max. Coil Voltage (VDC)	Rated Power (mW)
1.5	1.5	16.1	+1.13	+0.15	3.6	140
3	3	64.3	+2.25	+0.3	7.2	
4.5	4.5	145	+3.38	+0.45	10.8	
5	5	178	+3.75	+0.5	12.0	
6	6	257	+4.5	+0.6	14.4	
9	9	579	+6.75	+0.9	21.6	
12	12	1,028	+9	+1.2	28.8	
18	18	1,620	+13.5	+1.8	36.0	200
24	24	2,880	+18	+2.4	48.0	
48	48	7,680	+36	+4.8	84.0	300

Single winding latching type

Coil Code	Rated Coil Voltage (VDC)	Coil Resistance +/- 10% (Ohm)	Set Voltage (VDC) *	Reset Voltage (VDC) *	Rated Power (mW)
1.5	1.5	22.5	+1.13	-1.13	100
3	3	90	+2.25	-2.25	
4.5	4.5	203	+3.38	-3.38	
5	5	250	+3.75	-3.75	
6	6	360	+4.5	-4.5	
9	9	810	+6.75	-6.75	
12	12	1,440	+9	-9	
18	18	2,160	+13.5	-13.5	150
24	24	3,840	+18	-18	

Note: All values in the table are valid for 20°C and zero contact current.

\* Specified operate values are valid for pulse wave voltage.

# NA SERIES

## ■ COIL RATING

Double winding latching type

Coil Code	Rated Coil Voltage (VDC)	Coil Resistance +/- 10% (Ohm)	Set Voltage (VDC) *	Reset Voltage (VDC) *	Rated Power (mW)
1.5	1.5	P 11.25	+1.13		200
		S 11.25		+1.13	
3	3	P 45	+2.25		
		S 45		+2.25	
4.5	4.5	P 101	+3.38		
		S 101		+3.38	
5	5	P 125	+3.75		
		S 125		+3.75	
6	6	P 180	+4.5		
		S 180		+4.5	
9	9	P 405	+6.75		
		S 405		+6.75	
12	12	P 720	+9		
		S 720		+9	
18	18	P 1,080	+13.5		300
		S 1,080		+13.5	
24	24	P 1,920	+18		
		S 1,920		+18	

Note: All values in the table are measured at 20°C and zero contact current.

P: Primary coil S: Secondary coil

\* Specified values are measured with pulse wave voltage

## ■ SAFETY STANDARDS

Type	Compliance	Contact rating
UL	UL 508, UL 1950	Flammability: UL 94-V0 (plastics)
	E 45026	0.5A, 125VAC (general use) 2A, 30VDC (resistive)
CSA	C22.2 No. 14, No. 950 LR 35579	0.3A, 110VDC (resistive)

Complies to IEC60950-1; FCC part 68: Telcordia  
(Relay is only marked with UL and CSA logo)

## CHARACTERISTIC DATA

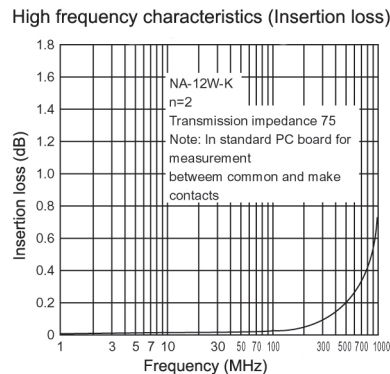
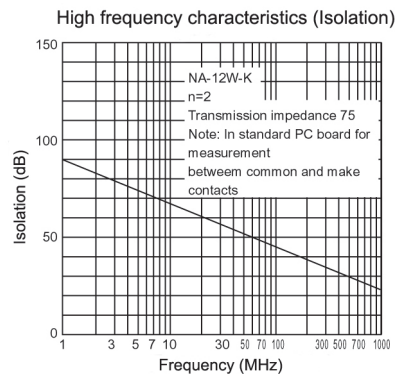
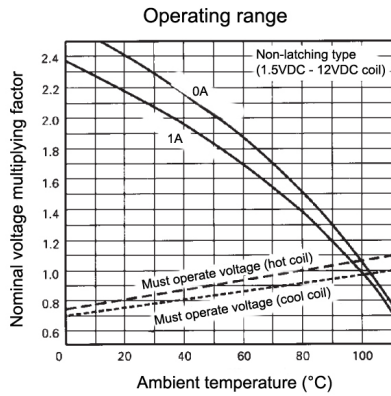
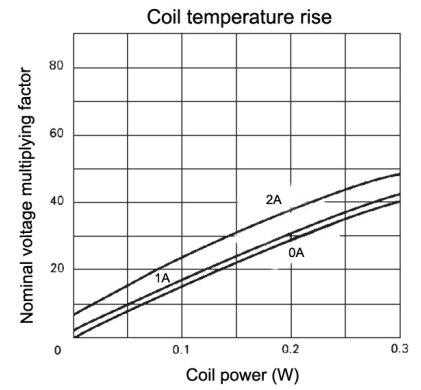
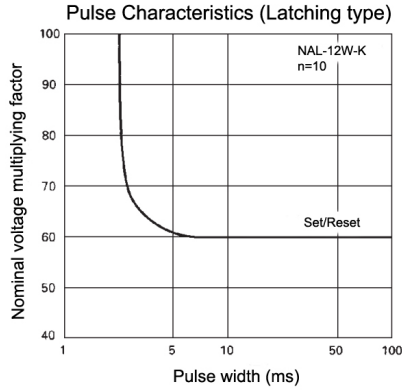
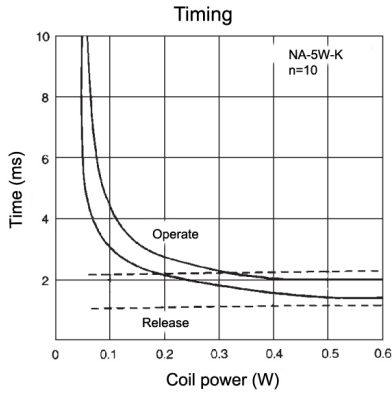

## REFERENCE DATA

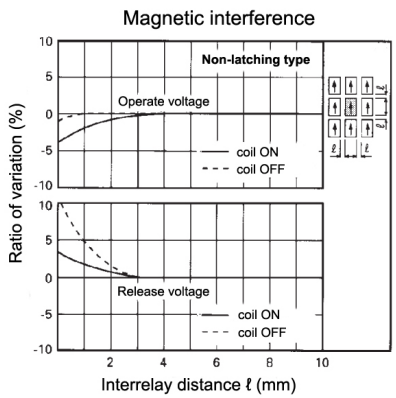
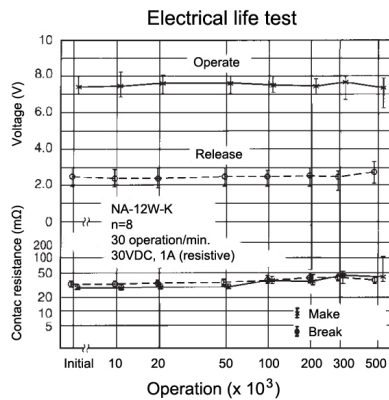
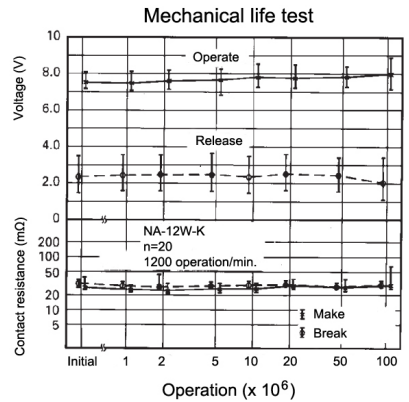
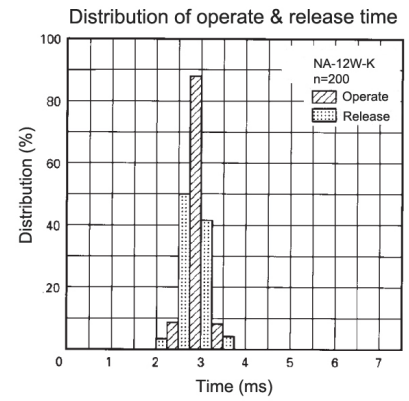

# NA SERIES

## ■ DIMENSIONS

- Dimensions

NA, NAL (Standard type, Single winding latching type)

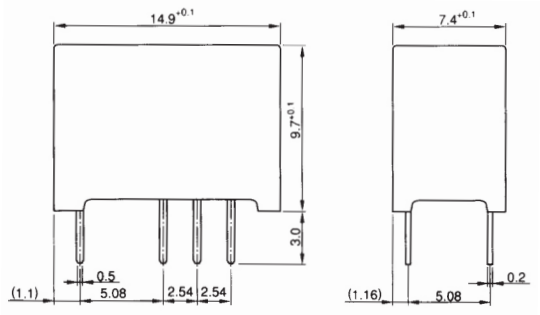

- Schematics (BOTTOM VIEW)

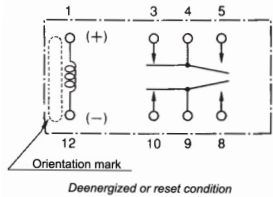

- PC board mounting hole layout (BOTTOM VIEW)

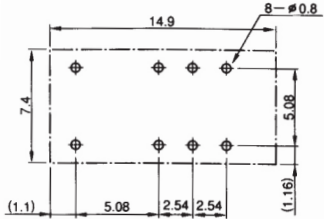

NAL-D (Double winding latching type)

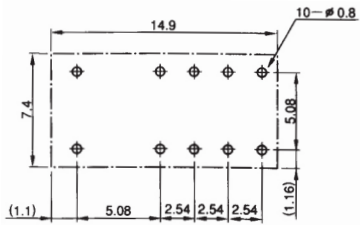
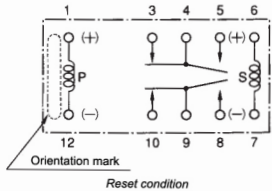
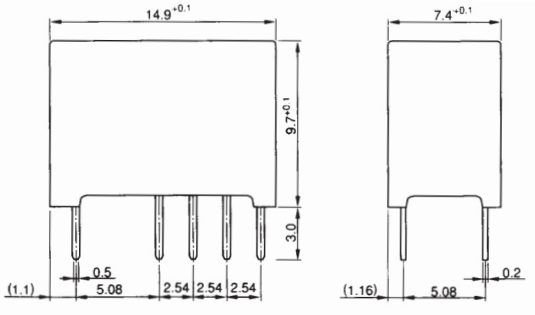

Unit: mm

## RoHS Compliance and Lead Free Information

### 1. General Information

- All signal and power relays produced by Fujitsu Components are compliant with RoHS directive 2002/95EC including amendments.
- Cadmium as used in electrical contacts is exempted from the RoHS directives on October 21st, 2005. (Amendment to Directive 2002/95/EC)
- All of our signal and power relays are lead-free. Please refer to Lead-Free Status Info for older date codes at: <http://www.fujitsu.com/us/downloads/MICRO/fcai/relays/lead-free-letter.pdf>
- Lead free solder plating on relay terminals is Sn-3.0Ag-0.5Cu, unless otherwise specified. This material has been verified to be compatible with PbSn assembly process.

### 2. Recommended Lead Free Solder Profile

- Recommended solder Sn-3.0Ag-0.5Cu.

**Flow Solder condition:**

Pre-heating: maximum 120°C  
Soldering: dip within 5 sec. at  
260°C solder bath

**Solder by Soldering Iron:**

Soldering Iron  
Temperature: maximum 360°C  
Duration: maximum 3 sec.

**We highly recommend that you confirm your actual solder conditions**

### 3. Moisture Sensitivity

- Moisture Sensitivity Level standard is not applicable to electromechanical relays, unless otherwise indicated.

### 4. Tin Whiskers

- Dipped SnAgCu solder is known as presenting a low risk to tin whisker development. No considerable length whisker was found by our in house test.



## Fujitsu Components International Headquarter Offices

### Japan

Fujitsu Component Limited  
Gotanda-Chuo Building  
3-5, Higashigotanda 2-chome, Shinagawa-ku  
Tokyo 141, Japan  
Tel: (81-3) 5449-7010  
Fax: (81-3) 5449-2626  
Email: [promothq@ft.ed.fujitsu.com](mailto:promothq@ft.ed.fujitsu.com)  
Web: [www.fcl.fujitsu.com](http://www.fcl.fujitsu.com)

### North and South America

Fujitsu Components America, Inc.  
250 E. Caribbean Drive  
Sunnyvale, CA 94089 U.S.A.  
Tel: (1-408) 745-4900  
Fax: (1-408) 745-4970  
Email: [components@us.fujitsu.com](mailto:components@us.fujitsu.com)  
Web: <http://us.fujitsu.com/components>

### Europe

Fujitsu Components Europe B.V.  
Diamantlaan 25  
2132 WV Hoofddorp  
Netherlands  
Tel: (31-23) 5560910  
Fax: (31-23) 5560950  
Email: [info@fceu.fujitsu.com](mailto:info@fceu.fujitsu.com)  
Web: [emea.fujitsu.com/components/](http://emea.fujitsu.com/components/)

### Asia Pacific

Fujitsu Components Asia Ltd.  
102E Pasir Panjang Road  
#01-01 CitiLink Warehouse Complex  
Singapore 118529  
Tel: (65) 6375-8560  
Fax: (65) 6273-3021  
Email: [fcal@fcal.fujitsu.com](mailto:fcal@fcal.fujitsu.com)  
Web: <http://www.fujitsu.com/sg/services/micro/components/>

©2011 Fujitsu Components Europe B.V. All rights reserved. All trademarks or registered trademarks are the property of their respective owners.

The contents, data and information in this datasheet are provided by Fujitsu Component Ltd. as a service only to its user and only for general information purposes.

The use of the contents, data and information provided in this datasheet is at the users' own risk.

Fujitsu has assembled this datasheet with care and will endeavor to keep the contents, data and information correct, accurate, comprehensive, complete and up to date.

Fujitsu Components Europe B.V. and affiliated companies do however not accept any responsibility or liability on their behalf, nor on behalf of its employees, for any loss or damage, direct, indirect or consequential, with respect to this datasheet, its contents, data, and information and related graphics and the correctness, reliability, accuracy, comprehensiveness, usefulness, availability and completeness thereof.

Nor do Fujitsu Components Europe B.V. and affiliated companies accept on their behalf, nor on behalf of its employees, any responsibility or liability for any representation or warrant of any kind, express or implied, including warranties of any kind for merchantability or fitness for particular use, with respect to these datasheets, its contents, data, information and related graphics and the correctness, reliability, accuracy, comprehensiveness, usefulness, availability and completeness thereof. Rev. March 02, 2011