Bluetooth® Low Energy Module

Features

- Fully certified Bluetooth® version 4.1 module
- On-board Bluetooth Low Energy 4.1 stack
- ASCII command interface API over UART
- Device Firmware Upgrade (DFU) over UART or Over the Air (OTA)
- Microchip Low-energy Data Profile (MLDP) for serial data applications
- Remote commands over-the-air
- 64 KB internal flash
- Compact form factor: 11.5 x 19.5 x 2.5 mm
- Castellated SMT pads for easy and reliable PCB mounting
- Environmentally friendly, RoHS compliant
- Certifications: FCC, IC, CE, QDID, VCCI, KCC, and NCC

Operational

- Single operating voltage: 1.8V to 3.6V (3.3V typical)
- Temperature range: -30°C to 85°C
- Low-power consumption
- Simple, UART interface
- Integrated Crystal, I²C Interface, Internal Voltage Regulator, Matching Circuitry, and PCB Antenna
- Multiple IOs for control and status
- GPIO, ADC
- Three Pulse Width Modulation (PWM) outputs

RF/Analog Features

- ISM Band 2.402 to 2.480 GHz operation
- Channels 0-39
- RX Sensitivity: -92.5 dBm at 0.1% BER
- TX Power: -19.0 dBm to +7.5 dBm
- RSSI Monitor

MAC/Baseband/Higher Layer Features

- Secure AES128 encryption
- GAP, GATT, SM, L2CAP, and integrated public profiles
- Create custom services using command API
- Keyboard I/O Authentication
- Software configurable role as peripheral or central and client or server
- Built-in scripting capabilities for hostless operation



Applications

- Health/Medical Devices
 - Glucose meters
 - Heart rate
 - Scale
- Sports Activity and Fitness
 - Pedometer
 - Cycling computer
 - Heart rate
- Retail
 - Point of Sale (POS)
 - Asset tagging and tracking
 - Proximity advertising
- Beacon Applications
- Internet of Things (IoT) Sensor tag
- Remote Control
 - Embedded Device Control
 - AV consoles and game controllers
- Wearable Smart Devices and Accessories
- Industrial Control
 - Private (custom) services
 - Low bandwidth cable replacement
- Smart Energy/Smart Home

Description

Microchip's RN4020 Bluetooth Low Energy Module provides a highly integrated solution for delivering low-power Bluetooth 4.1 solutions. The advanced command interface offers rapid time to market. The RN4020 module complies with Bluetooth specification version 4.1. The module integrates RF, a baseband controller, and a command API processor, making it a complete Bluetooth Low Energy solution. The RN4020 can be used with ultra-low cost microcontroller for intelligent Bluetooth Low Energy applications. For simple sensor applications, the RN4020 internal scripting capabilities enable basic functions to be implemented without the need for external host MCU or software development tools.

Table of Contents

1.0	Device Overview	3
2.0	General Specifications	6
3.0	Microcontroller to RN4020 Interface	7
4.0	Physical Dimensions	8
5.0	Typical Application Schematic	11
6.0	ASCII Command API	12
7.0	Supported Services	13
8.0	Regulatory Approval	15
9.0	Ordering Information	21
Appendix A: Revision History		23
The Microchip Web Site		25
Customer Change Notification Service		25
Customer Support		25

TO OUR VALUED CUSTOMERS

It is our intention to provide our valued customers with the best documentation possible to ensure successful use of your Microchip products. To this end, we will continue to improve our publications to better suit your needs. Our publications will be refined and enhanced as new volumes and updates are introduced.

If you have any questions or comments regarding this publication, please contact the Marketing Communications Department via E-mail at docerrors@microchip.com. We welcome your feedback.

Most Current Data Sheet

To obtain the most up-to-date version of this data sheet, please register at our Worldwide Web site at:

<http://www.microchip.com>

You can determine the version of a data sheet by examining its literature number found on the bottom outside corner of any page. The last character of the literature number is the version number, (e.g., DS30000000A is version A of document DS30000000).

Errata

An errata sheet, describing minor operational differences from the data sheet and recommended workarounds, may exist for current devices. As device/documentation issues become known to us, we will publish an errata sheet. The errata will specify the revision of silicon and revision of document to which it applies.

To determine if an errata sheet exists for a particular device, please check with one of the following:

- Microchip's Worldwide Web site; <http://www.microchip.com>
- Your local Microchip sales office (see last page)

When contacting a sales office, please specify which device, revision of silicon and data sheet (include literature number) you are using.

Customer Notification System

Register on our web site at www.microchip.com to receive the most current information on all of our products.

1.0 DEVICE OVERVIEW

The RN4020 Bluetooth Low Energy RF module integrates Bluetooth 4.1 radio baseband, MCU, digital analog I/O, on-board stack, and ASCII command API. Figure 1-1 shows the top view of the module. The pinout of the module is shown in Figure 1-2, and the description is presented in Table 1-1. Figure 1-3 lists all the key components of the module.

FIGURE 1-1: RN4020 TOP VIEW



FIGURE 1-2: RN4020 PIN DIAGRAM

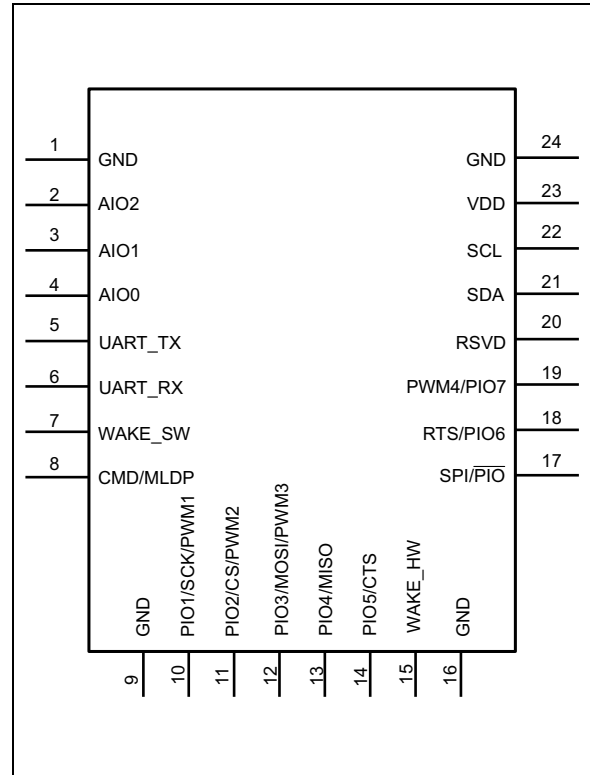
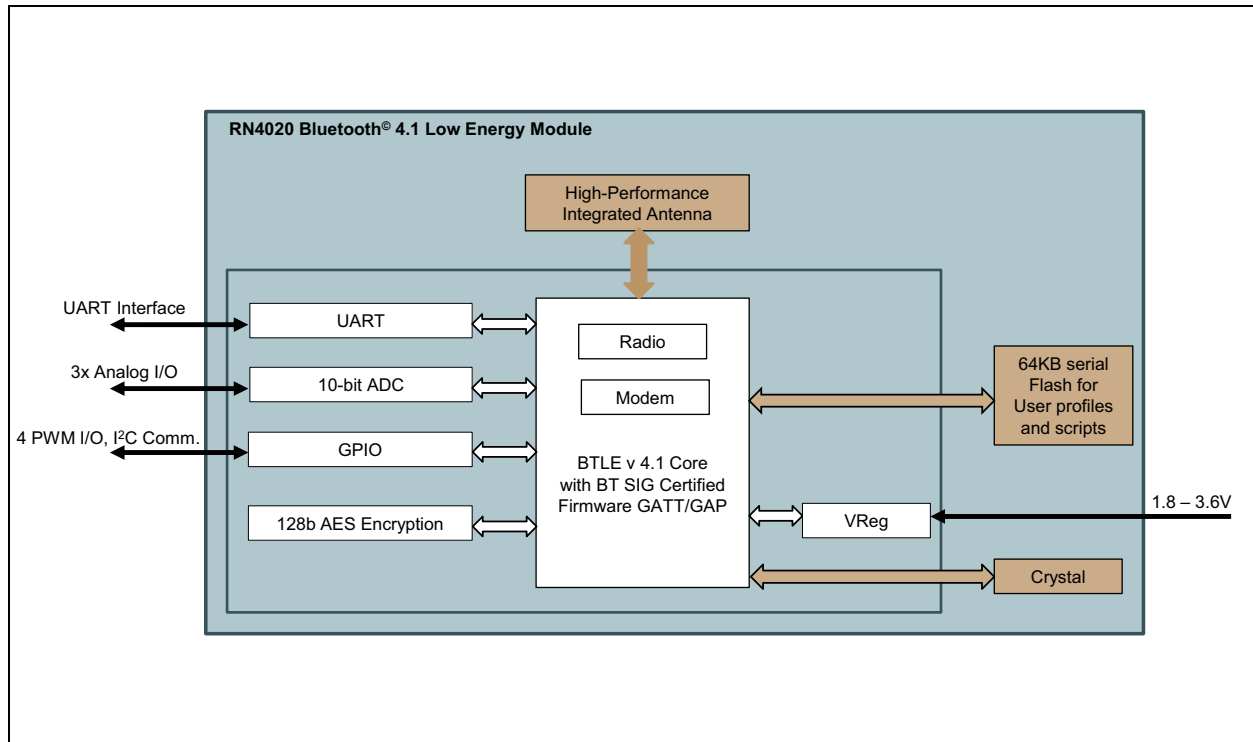

FIGURE 1-3: RN4020 BLOCK DIAGRAM



RN4020

TABLE 1-1: PIN DESCRIPTION

Pin	Name	Description	Function
1	GND	Ground	Ground
2	AIO2	Bi-directional with programmable analog I/O	1.35V and 30 mA max out
3	AIO1	Bi-directional with programmable analog I/O	1.35V and 30 mA max out
4	AIO0	Bi-directional with programmable analog I/O	1.35V and 30 mA max out
5	UART TX	UART Transmit (TX)	Output
6	UART RX	UART Receive (RX)	Input
7	WAKE_SW	Deep Sleep Wake; active-high to wake module from Deep Sleep. If the module runs without a host micro-controller, connect the UART_RX pin to VDD via a 10K resistor to conserve power in Deep Sleep.	Input; weak pull down
8	CMD/MLDP	Command or MLDP mode – In Command mode, UART traffic is sent to the command interpreter. In MLDP mode, UART traffic is routed to the MLDP Bluetooth LED connection, if active.	Input; Edge triggered; Change from High to Low to enter CMD mode from MLDP mode
9	GND	Ground	Ground
10	CONNECTION LED PIO[1] SCK PWM1	Default state is output. Active-high indicates the module is connected to a remote device. Active-low indicates a disconnected state. Configurable as PIO[1] via software command. SCK for Diagnostics and Factory Calibration if pin 17 is asserted.	<ul style="list-style-type: none"> • Connection Status Indicator (Green LED) • PIO[1] • SCK • PWM1
11	MLDP_EV PIO[2] CS PWM2	Default function is output used for MLDP data event indicator (Red LED). Active-high indicates MLDP data received or UART console data pending. Low level indicates no events. Event is only triggered in MLDP mode, when CMD/MLDP (pin 8) is high. Configurable as PIO[2] via “ I” and “ O” commands. CS for Diagnostics and Factory Calibration if pin 17 is asserted.	<ul style="list-style-type: none"> • MLDP Data Indicator (Red LED) • PIO[2] • CS • PWM2
12	WS PIO[3] MOSI PWM3	Default function is an output used for Activity Indicator (Blue LED). High level indicates module is awake and active. Low level indicates module is in a Sleep state. Accessible as PIO[3] via “ >” and “ <” commands. MOSI for Diagnostics and Factory Calibration if pin 17 is asserted.	<ul style="list-style-type: none"> • WS (Blue LED) • PIO[3] • MOSI • PWM3
13	PIO[4] MISO	MISO for Diagnostics and Factory Calibration if pin 17 asserted.	<ul style="list-style-type: none"> • PIO[4] • MISO
14	CTS PIO[5]	Reserved for CTS if hardware flow control is enabled on the UART; active-low.	<ul style="list-style-type: none"> • CTS (input) • PIO[5]

TABLE 1-1: PIN DESCRIPTION (CONTINUED)

Pin	Name	Description	Function
15	WAKE_HW	<p>Hardware wake from Dormant state. Setting the WAKE_HW (pin15) high wakes the module from Dormant mode. During the module power up, if WAKE_HW pin is flipped high and low for three cycles (putting the WAKE_HW pin into high, low, and then high again is considered as one flip cycle) in the first five seconds, then the module performs a factory Reset. If the WAKE_SW pin is high when a factory Reset is performed, the factory Reset is a full reset. Otherwise, it is a partial reset that retains the device name, private service and scripts. Set WAKE_HW pin to low in order to lower power consumption in Deep Sleep and Dormant modes.</p> <div style="border: 1px solid black; padding: 5px; margin: 10px 0;"> <p style="text-align: center;">CAUTION</p> <p>A full factory Reset erases scripts and sets the device name to the serialized name. For more information, refer to the <code>SF</code> Command in the <i>RN4020 Bluetooth Low Energy User's Guide</i> (DS70005191).</p> </div>	Active-high; internal pull down
16	GND	Ground	Ground
17	SPI/ $\overline{\text{PIO}}$	SPI/ $\overline{\text{PIO}}$ for pins 10-13; active-high	Input with internal pull down; selects SPI on pins 10-13
18	RTS PIO[6]	Reserved for RTS if hardware flow control on UART is enabled. If the data transmission to RN4020 must be halted, assert RTS to high. RTS pin operates independently from the CTS (pin 14).	<ul style="list-style-type: none"> • RTS (output) • PIO[6]
19	PWM4 PIO[7]	Spare PIO	PIO[7]; Spare PIO configurable as input or output
20	RSVD	Do not connect. Factory diagnostics.	No Connect
21	SDA	SDA Data line of the I ² C interface. The RN4020 always acts as the I ² C Master.	SDA
22	SCL	I ² C Clock	SCL
23	VDD	Supply voltage	1.8 to 3.6V
24	GND	Ground	Ground

RN4020

2.0 GENERAL SPECIFICATIONS

Table 2-1 provides the general specifications of the module. Table 2-2 and Table 2-3 shows the weight and dimensions, and electrical characteristics of the module. Table 2-4 and Table 2-5 specify the current consumption of the module.

TABLE 2-1: GENERAL SPECIFICATIONS

Specification	Description
Standard	Bluetooth 4.1
Frequency Band	2.4 ~ 2.48 GHz
Modulation Method	GFSK
Maximum Data Rate	1 Mbps
Antenna	PCB
Interface	UART, PIO, AIO, SPI
Operation Range	100 meters ⁽¹⁾
Sensitivity	-92.5 dBm at 0.1% BER
RF TX Power	-19.0 dBm to +7.5 dBm
Temperature (operating)	-30°C to +85°C
Temperature (storage)	-40°C to +85°C
Humidity	10% ~ 90% non-condensing

Note 1: Maximum range under ideal conditions such as RF matching, line of sight, maximum power. Actual results may vary depending on the customer's design.

TABLE 2-2: WEIGHT AND DIMENSIONS

Specification	Description
Dimensions	11.5 x 19.5 x 2.5 mm
Weight	1.2g

TABLE 2-3: ELECTRICAL CHARACTERISTICS

Specification	Description
Supply Voltage	1.8 to 3.6V DC
Working current	Depends on profiles, 12 mA typical

TABLE 2-4: CURRENT CONSUMPTION

Mode	Typical Current at 3V
Dormant	<900 nA
Deep Sleep	<5.0 μ A
Idle	<1.5 mA
TX/RX active	16 mA

TABLE 2-5: CURRENT CONSUMPTION VS RF TX POWER

RN4020, V _{DD} = 3.3V, 25°C	
TX Power (dBm)	I _d (mA)
-19.1	14.0
-15.1	14.4
-10.9	15.0
-6.9	15.9
-2.5	17.6
1.6	20.7
5.8	26.9
7.5	33.6

3.0 MICROCONTROLLER TO RN4020 INTERFACE

Figure 3-1 illustrates the interface between PIC microcontroller and the RN4020 module.

The minimum interface consists of UART and WAKE_HW lines. This enables the microcontroller to communicate with the RN4020 module using ASCII command API. The command API is described in Section 6.0 “ASCII Command API”.

3.1 CTS/RTS Hardware Flow Control

For customer applications using the Microchip Low-energy Data Profile, Pin 8 (CMD/MLDP) is required. CTS/RTS hardware control is also required for this service to avoid buffer overruns.

3.2 Microchip Low-energy Data Profile (MLDP)

The Microchip Low-energy Data Profile is a private BTLE service that provides a 50 kbps serial data transport over Bluetooth Low Energy on the RN4020. Pin 8 (CMD/MLDP) is required. CTS/RTS hardware control is also highly recommended for this service to avoid data loss.

For more information on how to use the MLDP data service, refer to *RN4020 Bluetooth Low Energy Module User’s Guide* (DS70005191).

FIGURE 3-1: INTERFACE DESCRIPTION

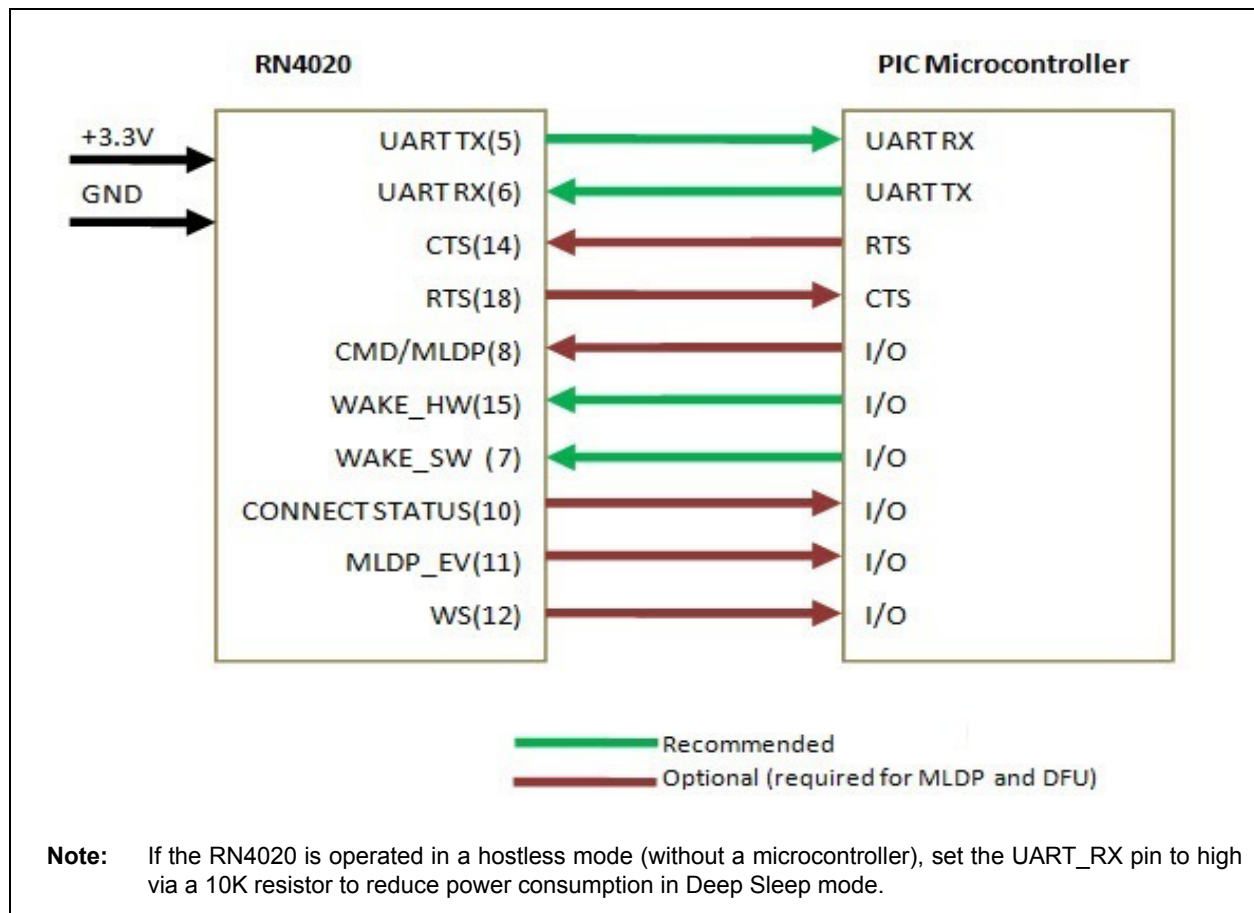

RN4020

4.0 PHYSICAL DIMENSIONS

Figure 4-1 shows the physical dimensions for RN4020 module. Figure 4-2 illustrates the recommended PCB layout. It is recommended that when laying out the carrier board for the RN4020 module, the areas under the antenna, RF test point (semi-circular pad), and shielding connections do not contain surface traces, ground planes, or exposed vias.

Figure 4-3 specifies the recommended mounting details. For optimal radio performance, it is recommended that the antenna end of the RN4020 module protrudes at least 31 mm beyond any metal enclosure. Figure 4-4 shows an example of good and acceptable positioning of the RN4020 on the host PCB.

FIGURE 4-1: RN4020 MODULE DIMENSIONS

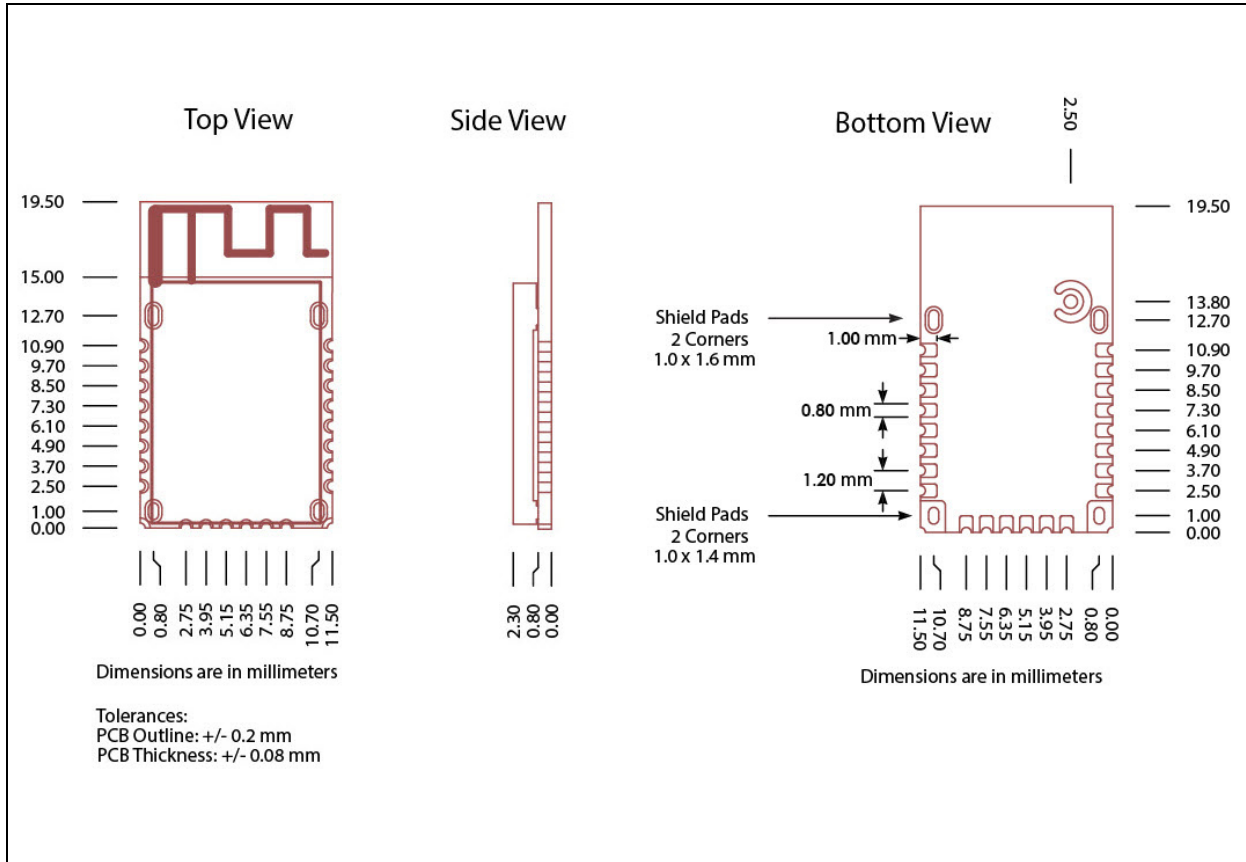

FIGURE 4-2: RN4020 RECOMMENDED PCB FOOTPRINT

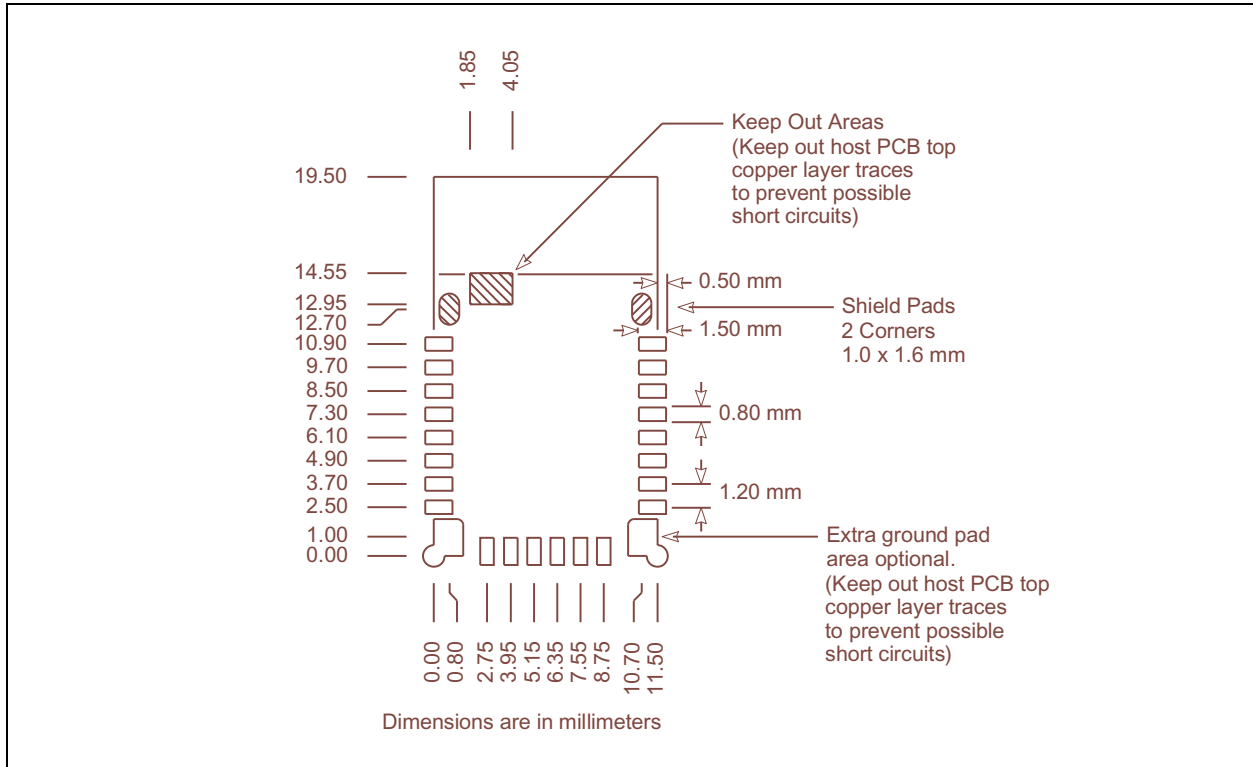
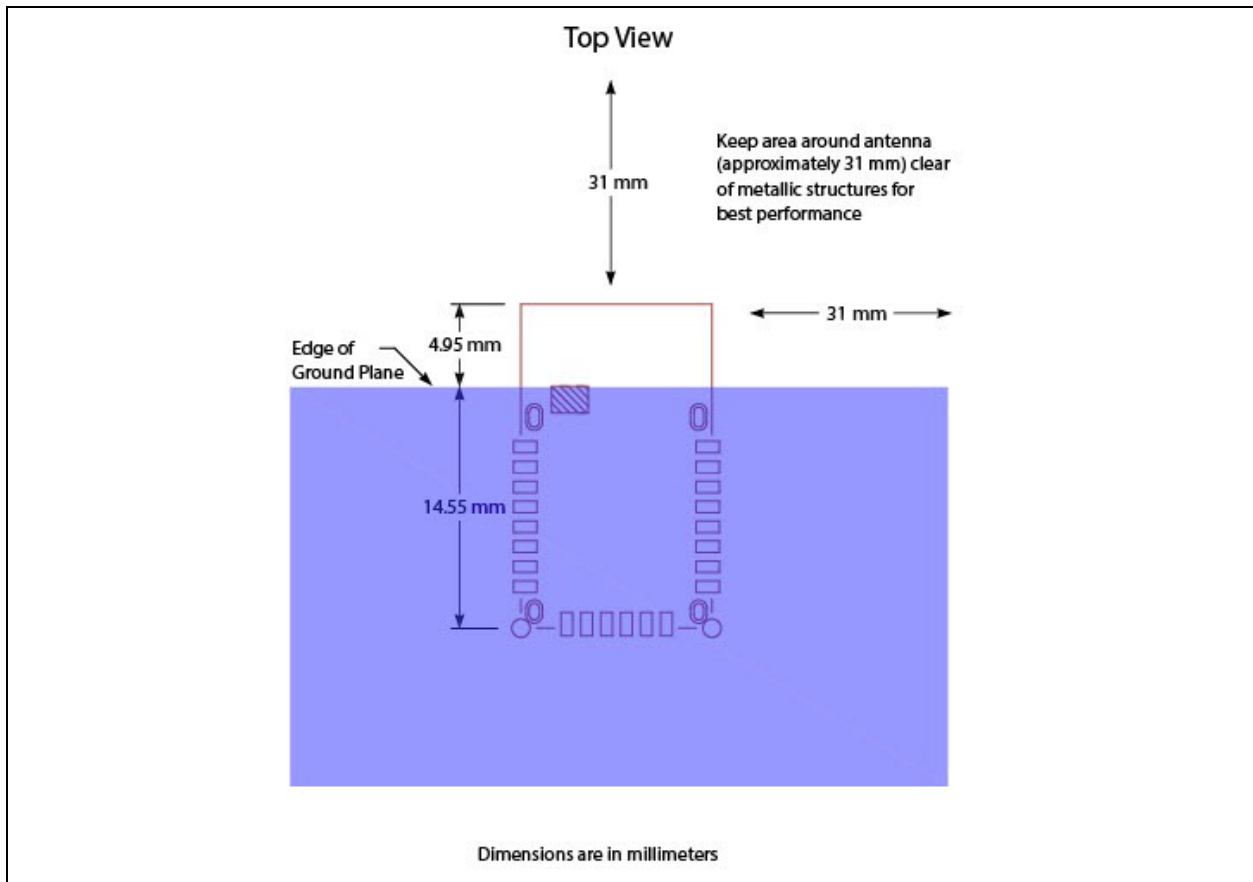
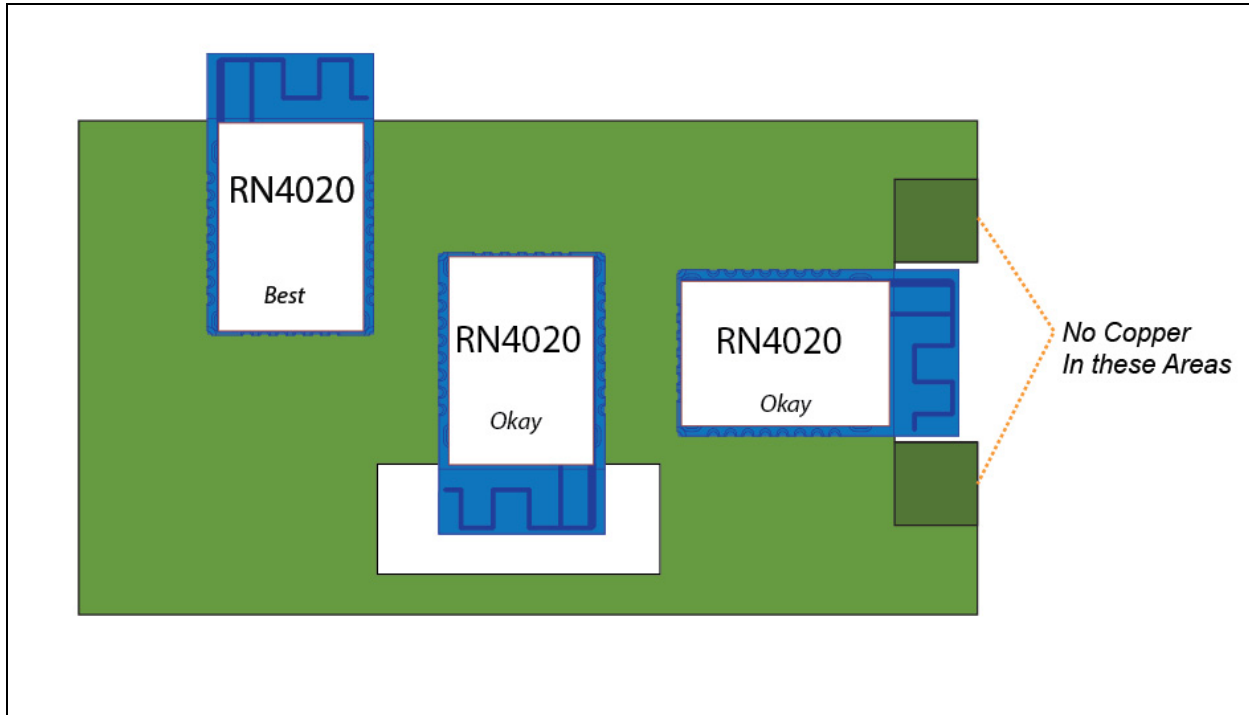

FIGURE 4-3: RN4020 MODULE MOUNTING DETAILS



RN4020

FIGURE 4-4: RN4020 HOST PCB EXAMPLE LAYOUT



RN4020

6.0 ASCII COMMAND API

The RN4020 command API is documented in *RN4020 Bluetooth Low Energy Module User's Guide* (DS70005191).

Commands are categorized into the following functions:

- Built-in Public Services
 - Enable/Disable service as Server or Client
 - Read/Write characteristic values
 - Set notification for characteristic
- Max TX Power
 - Set power in dB
- GAP Role
 - Central, Peripheral, Observer and Broadcaster
- Advertising
 - Start/Stop
- Bonding
 - Bond/Unbound to Master
- Private Service
 - Set private service UUID
 - Set characteristic UUID for private service
 - Set private service filter
- Microchip Low-energy Data Profile (MLDP)
 - Enable
 - Enter MLDP mode
 - Peripheral side configuration
 - Central side configuration
- Device Information Profile settings
- Connection
 - Status
 - Disconnect
 - Kill active connection
 - Establish connection (Central role only)
 - Start/Stop inquiry scan for other devices (Central role only)
- IO
 - Configure GPIO mask
 - Set/Get GPIO states
 - Ready and Write ADC values
 - Read/Write I²C
 - Configure PWM
 - Device Firmware Update
 - Accessing remote configuration
- System
 - Reboot
 - Factory default
 - Display configuration
- Scripting
 - Enter script mode
 - Declare event handler
 - Execute current script
 - List current script
 - Clear script
 - Define User function

7.0 SUPPORTED SERVICES

The RN4020 firmware support the built-in public services listed in [Table 7-1](#). The services are enabled via Command API and serviced in the same manner. Each service manages “Characteristics” which are declared and defined by Bluetooth as data values. The values for each characteristic are cached in modules memory and can be read by another Bluetooth device such as smartphone acting in Central role. The values of every Characteristic are updated via Command API over UART.

TABLE 7-1: SUPPORTED PUBLIC SERVICES ON RN4020⁽¹⁾

Service Name	Bluetooth SIG UUID
Device Information	0x180A
Battery	0x180F
Heart Rate	0x180D
Health Thermometer	0x1809
Glucose	0x1808
Blood Pressure	0x1810
Running Speed Cadence	0x1814
Cycling Speed Cadence	0x1816
Current Time	0x1805
Next DST Change	0x1807
Reference Time Update	0x1806
Link Loss	0x1803
Immediate Alert	0x1802
TX Power	0x1804
Alert Notification	0x1811
Phone Alert Status	0x180E
Scan Parameters	0x1813

Note 1: The services listed above are based on firmware version 1.20. For the latest list of supported services, refer to the firmware version on the RN4020 web page.

7.1 Public and Private Services

The RN4020 provides the ability to create private service. If the services are supported on both end points of a Bluetooth Low Energy connection, such as Central and Peripheral devices, data can be exchanged. For example, two RN4020 modules can define a custom (private) service with its own unique UUID and GATT characteristics. Data can be exchanged easily via Command API.

Private services are not registered with the Bluetooth SIG, and therefore not interoperable with other Bluetooth Low Energy devices, unless the device implements the private service. An example of a built-in private service is Microchip Streaming Data service.

For an example on how to create a custom service using the RN4020, refer to *RN4020 Bluetooth Low Energy Module User’s Guide* (DS70005191).

7.2 PCB Antenna

The PCB antenna is fabricated on the top copper layer and covered in solder mask. The layers below the antenna do not have copper trace. It is recommended that the module is mounted on the edge of the host PCB. Having PCB material below the antenna structure is permitted as long as no copper traces or planes are on the host PCB in that area.

[Table 7-2](#) provides the antenna specification.

TABLE 7-2: ANTENNA CHARACTERISTICS

Specification	Description
Type	PCB
Frequency Range	2.402 to 2.485 MHz
Peak Gain	-0.23 dBi

[Figure 7-1](#), [Figure 7-2](#), and [Figure 7-3](#) show the antenna efficiency, the antenna plot, and the 3D radiation pattern.

FIGURE 7-1: EFFICIENCY

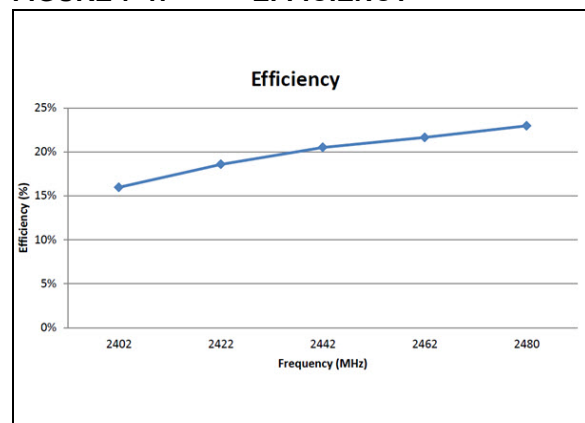

RN4020

FIGURE 7-2: ANTENNA PLOT

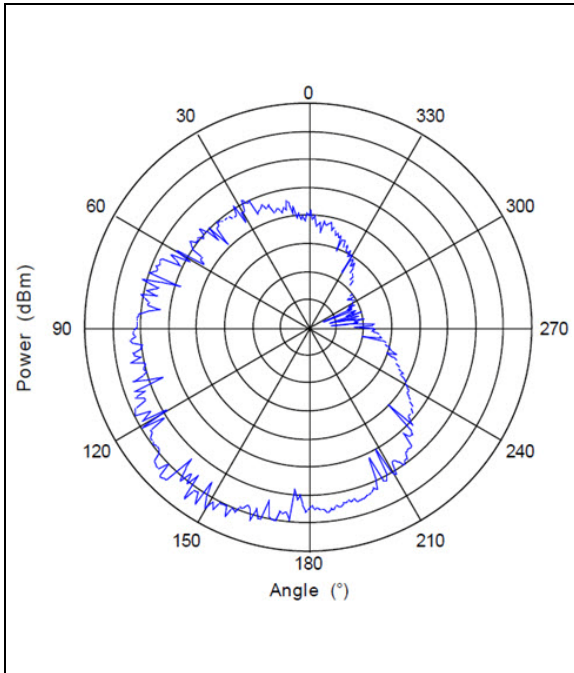
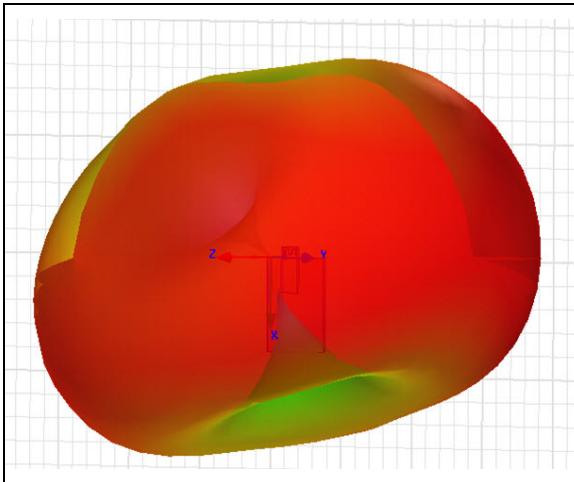

FIGURE 7-3: 3D RADIATION PATTERN AND ANTENNA ORIENTATION



7.3 Soldering Recommendations

The RN4020 wireless module is assembled using standard lead-free reflow profile IPC/JEDEC J-STD-020.

The module can be soldered to the host PCB using standard leaded and lead-free solder reflow profiles.

To avoid damaging the module, the following recommendations are given:

- Microchip Technology Application Note, *AN233 Solder Reflow Recommendation* (DS00233) provides solder reflow recommendations
- Do not exceed peak temperature (T_p) of 250°C
- Refer to the solder paste data sheet for specific reflow profile recommendations
- Use no-clean flux solder paste
- Do not wash as moisture can be trapped under the shield
- Use only one flow. If the PCB requires multiple flows, apply the module on the final flow.

8.0 REGULATORY APPROVAL

This section outlines the regulatory information for the RN4020 module for the following countries:

- United States
- Canada
- Europe
- Australia
- New Zealand
- Japan
- Korea
- Taiwan

8.1 United States

The RN4020 module has received Federal Communications Commission (FCC) CFR47 Telecommunications, Part 15 Subpart C “Intentional Radiators” modular approval in accordance with Part 15.212 Modular Transmitter approval. Modular approval allows the end user to integrate the RN4020 module into a finished product without obtaining subsequent and separate FCC approvals for intentional radiation, provided no changes or modifications are made to the module circuitry. Changes or modifications could void the user’s authority to operate the equipment. The end user must comply with all of the instructions provided by the Grantee, which indicate installation and/or operating conditions necessary for compliance.

The finished product is required to comply with all applicable FCC equipment authorizations regulations, requirements and equipment functions not associated with the transmitter module portion. For example, compliance must be demonstrated to regulations for other transmitter components within the host product; to requirements for unintentional radiators (Part 15 Subpart B “Unintentional Radiators”), such as digital devices, computer peripherals, radio receivers, etc.; and to additional authorization requirements for the non-transmitter functions on the transmitter module (i.e., Verification, or Declaration of Conformity) (e.g., transmitter modules may also contain digital logic functions) as appropriate.

8.1.1 LABELING AND USER INFORMATION REQUIREMENTS

The RN4020 module has been labeled with its own FCC ID number, and if the FCC ID is not visible when the module is installed inside another device, then the outside of the finished product into which the module is installed must also display a label referring to the enclosed module. This exterior label can use wording as follows:

RN4020:
Contains Transmitter Module FCC ID: T9JRN4020
or

Contains FCC ID: T9JRN4020

This device complies with Part 15 of the FCC Rules. Operation is subject to the following two conditions: (1) this device may not cause harmful interference, and (2) this device must accept any interference received, including interference that may cause undesired operation

A user’s manual for the product should include the following statement:

This equipment has been tested and found to comply with the limits for a Class B digital device, pursuant to part 15 of the FCC Rules. These limits are designed to provide reasonable protection against harmful interference in a residential installation. This equipment generates, uses and can radiate radio frequency energy, and if not installed and used in accordance with the instructions, may cause harmful interference to radio communications. However, there is no guarantee that interference will not occur in a particular installation. If this equipment does cause harmful interference to radio or television reception, which can be determined by turning the equipment off and on, the user is encouraged to try to correct the interference by one or more of the following measures:

- Reorient or relocate the receiving antenna.
- Increase the separation between the equipment and receiver.
- Connect the equipment into an outlet on a circuit different from that to which the receiver is connected.
- Consult the dealer or an experienced radio/TV technician for help.

Additional information on labeling and user information requirements for Part 15 devices can be found in KDB Publication 784748 available at the FCC Office of Engineering and Technology (OET) Laboratory Division Knowledge Database (KDB)

<http://apps.fcc.gov/oetcf/kdb/index.cfm>

RN4020

8.1.2 RF EXPOSURE

All transmitters regulated by FCC must comply with RF exposure requirements. KDB 447498 General RF Exposure Guidance provides guidance in determining whether proposed or existing transmitting facilities, operations or devices comply with limits for human exposure to Radio Frequency (RF) fields adopted by the Federal Communications Commission (FCC).

This module is approved for installation into mobile and/or portable host platforms and must not be co-located or operating in conjunction with any other antenna or transmitter except in accordance with FCC multitransmitter guidelines. End users must be provided with transmitter operating conditions for satisfying RF Exposure compliance.

8.1.3 HELPFUL WEB SITES

Federal Communications Commission (FCC):
<http://www.fcc.gov>

FCC Office of Engineering and Technology (OET) Laboratory Division Knowledge Database (KDB):
<http://apps.fcc.gov/oetcf/kdb/index.cfm>

8.2 Canada

The RN4020 module has been certified for use in Canada under Industry Canada (IC) Radio Standards Specification (RSS) RSS-210 and RSSGen. Modular approval permits the installation of a module in a host device without the need to recertify the device.

8.2.1 LABELING AND USER INFORMATION REQUIREMENTS

Labeling Requirements for the Host Device (from Section 3.2.1, RSS-Gen, Issue 3, December 2010): The host device shall be properly labeled to identify the module within the host device.

The Industry Canada certification label of a module shall be clearly visible at all times when installed in the host device, otherwise the host device must be labeled to display the Industry Canada certification number of the module, preceded by the words "Contains transmitter module", or the word "Contains", or similar wording expressing the same meaning, as follows:

Contains transmitter module IC: 6514A-RN4020

User Manual Notice for License-Exempt Radio Apparatus (from Section 7.1.3 RSS-Gen, Issue 3, December 2010): User manuals for license-exempt radio apparatus shall contain the following or equivalent notice in a conspicuous location in the user manual or alternatively on the device or both:

This device complies with Industry Canada license-exempt RSS standard(s). Operation is subject to the following two conditions: (1) this device may not cause interference, and (2) this device must accept any interference, including interference that may cause undesired operation of the device.

Le présent appareil est conforme aux CNR d'Industrie Canada applicables aux appareils radio exempts de licence. L'exploitation est autorisée aux deux conditions suivantes: (1) l'appareil ne doit pas produire de brouillage, et (2) l'utilisateur de l'appareil doit accepter tout brouillage radioélectrique subi, même si le brouillage est susceptible d'en compromettre le fonctionnement.

Transmitter Antenna (from Section 7.1.2 RSS-Gen, Issue 3, December 2010): User manuals for transmitters shall display the following notice in a conspicuous location:

Under Industry Canada regulations, this radio transmitter may only operate using an antenna of a type and maximum (or lesser) gain approved for the transmitter by Industry Canada. To reduce potential radio interference to other users, the antenna type and its gain should be so chosen that the equivalent isotropically radiated power (e.i.r.p.) is not more than that necessary for successful communication.

Conformément à la réglementation d'Industrie Canada, le présent émetteur radio peut fonctionner avec une antenne d'un type et d'un gain maximal (ou inférieur) approuvé pour l'émetteur par Industrie Canada. Dans le but de réduire les risques de brouillage radioélectrique à l'intention des autres utilisateurs, il faut choisir le type d'antenne et son gain de sorte que la puissance isotrope rayonnée équivalente (p.i.r.e.) ne dépasse pas l'intensité nécessaire à l'établissement d'une communication satisfaisante.

The above notice may be affixed to the device instead of displayed in the user manual.

8.2.2 RF EXPOSURE

All transmitters regulated by IC must comply with RF exposure requirements listed in RSS-102 - Radio Frequency (RF) Exposure Compliance of Radiocommunication Apparatus (All Frequency Bands).

This module is approved for installation into mobile and/or portable host platforms and must not be co-located or operating in conjunction with any other antenna or transmitter except in accordance with Industry Canada's multi-transmitter guidelines. End users must be provided with transmitter operating conditions for satisfying RF Exposure compliance.

8.2.3 APPROVED EXTERNAL ANTENNA TYPES

Transmitter Antenna (from Section 7.1.2 RSS-Gen, Issue 3, December 2010):

The RN4020 module can only be sold or operated with antennas with which it was approved. Transmitter may be approved with multiple antenna types. An antenna type comprises antennas having similar in-band and out-of-band radiation patterns. Testing shall be performed using the highest gain antenna of each combination of transmitter and antenna type for which approval is being sought, with the transmitter output power set at the maximum level. Any antenna of the same type having equal or lesser gain as an antenna that had been successfully tested with the transmitter, will also be considered approved with the transmitter, and may be used and marketed with the transmitter.

When a measurement at the antenna connector is used to determine RF output power, the effective gain of the device's antenna shall be stated, based on measurement or on data from the antenna manufacturer. For transmitters of output power greater than 10 milliwatts, the total antenna gain shall be added to the measured RF output power to demonstrate compliance to the specified radiated power limits.

8.2.4 HELPFUL WEB SITES

Industry Canada: <http://www.ic.gc.ca/>

8.3 Europe

The RN4020 module is an R&TTE Directive assessed radio module that is CE marked and has been manufactured and tested with the intention of being integrated into a final product.

The RN4020 module has been tested to R&TTE Directive 1999/5/EC Essential Requirements for Health and Safety (Article (3.1(a)), Electromagnetic Compatibility (EMC) (Article 3.1(b)), and Radio (Article 3.2) and are summarized in Table 3-1: European Compliance Testing. A Notified Body Opinion has also been issued. All test reports are available on the RN4020 product web page at <http://www.microchip.com>.

The R&TTE Compliance Association provides guidance on modular devices in document **Technical Guidance Note 01** available at http://www.rteca.com/html/download_area.htm.

Note: To maintain conformance to the testing listed in [Table 8-1](#), the module shall be installed in accordance with the installation instructions in this data sheet and shall not be modified.

When integrating a radio module into a completed product the integrator becomes the manufacturer of the final product and is therefore responsible for demonstrating compliance of the final product with the essential requirements of the R&TTE Directive.

8.3.1 LABELING AND USER INFORMATION REQUIREMENTS

The label on the final product which contains the RN4020 module must follow CE marking requirements. The "*R&TTE Compliance Association Technical Guidance Note 01*" provides guidance on final product CE marking.

8.3.2 ANTENNA REQUIREMENTS

From R&TTE Compliance Association document **Technical Guidance Note 01**:

Provided the integrator installing an assessed radio module with an integral or specific antenna and installed in conformance with the radio module manufacturer's installation instructions requires no further evaluation under Article 3.2 of the R&TTE Directive and does not require further involvement of an R&TTE Directive Notified Body for the final product. [Section 2.2.4]

8.3.3 HELPFUL WEB SITES

A document that can be used as a starting point in understanding the use of Short Range Devices (SRD) in Europe is the European Radio Communications Committee (ERC) Recommendation 70-03 E, which can be downloaded from the European Radio Communications Office (ERO) at: <http://www.ero.dk/>.

Additional helpful web sites are:

- Radio and Telecommunications Terminal Equipment (R&TTE): http://ec.europa.eu/enterprise/rtte/index_en.htm
- European Conference of Postal and Telecommunications Administrations (CEPT): <http://www.cept.org/>
- European Telecommunications Standards Institute (ETSI): <http://www.etsi.org>

RN4020

- European Radio Communications Office (ERO):
<http://www.ero.dk/>
- The Radio and Telecommunications Terminal Equipment Compliance Association (R&TTE CA):
<http://www.rtteca.com/>

TABLE 8-1: RN4020 EUROPEAN COMPLIANCE TESTING

Certification	Standards	Article	Laboratory	Report Number	Date
Safety	EN 60950-1:2006+A11:2009+A1:2010 +A12:2011	[3.1(a)]		Pending	
Health	EN 62479:2010			Pending	
EMC	EN 301 489-1 V1.9.2 (2011-09)	[3.1(b)]		Pending	
	EN 301 489-17 V2.2.1 (2012-09)				
Radio	EN 300 328 V1.8.1 (2006-06)	(3.2)		Pending	
Notified Body Opinion	CE0984			Pending	

8.4 Australia

The Australia radio regulations do not provide a modular approval policy similar to the United States (FCC) and Canada (IC). However, RN4020 module RF transmitter test reports can be used in part to demonstrate compliance in accordance with ACMA Radio communications “Short Range Devices” Standard 2004 (The Short Range Devices standard calls up the AS/NZS 4268:2008 industry standard). The RN4020 module test reports can be used as part of the product certification and compliance folder. For more information on the RF transmitter test reports, contact Microchip Technology Australia sales office.

To meet overall Australian final product compliance, the developer must construct a compliance folder containing all relevant compliance test reports e.g. RF, EMC, electrical safety and DoC (Declaration of Conformity) etc. It is the responsibility of the integrator to know what is required in the compliance folder for ACMA compliance. All test reports are available on the RN4020 product web page at <http://www.microchip.com>. For more information on Australia compliance, refer to the Australian Communications and Media Authority web site <http://www.acma.gov.au/>.

8.4.1 HELPFUL WEB SITE

The Australian Communications and Media Authority:
www.acma.gov.au/.

8.5 New Zealand

The New Zealand radio regulations do not provide a modular approval policy similar to the United States (FCC) and Canada (IC). However, RN4020 module RF transmitter test reports can be used in part to demonstrate compliance against the New Zealand “General User Radio License for Short Range Devices”. New Zealand Radio communications (Radio Standards) Notice 2010 calls up the AS / NZS 4268:2008 industry standard. The RN4020 module test reports can be used as part of the product certification and compliance folder. All test reports are available on the RN4020 product web page at <http://www.microchip.com>. For more information on the RF transmitter test reports, contact Microchip Technology sales office.

Information on the New Zealand short range devices license can be found in the following web links:

<http://www.rsm.govt.nz/cms/licensees/types-oflicence/general-user-licences/short-range-devices>

and

<http://www.rsm.govt.nz/cms/policy-and-planning/spectrum-policy-overview/legislation/gazette-notices/product-compliance>

To meet overall New Zealand final product compliance, the developer must construct a compliance folder containing all relevant compliance test reports e.g. RF, EMC, electrical safety and DoC (Declaration of Conformity) etc. It is the responsibility of the developer to know what is required in the compliance folder for New Zealand Radio communications. For more information on New Zealand compliance, refer to the web site

<http://www.rsm.govt.nz/>.

8.6 Japan

The RN4020 module has received type certification and is labeled with its own technical conformity mark and certification number as required to conform to the technical standards regulated by the Ministry of Internal Affairs and Communications (MIC) of Japan pursuant to the Radio Act of Japan.

Integration of this module into a final product does not require additional radio certification provided installation instructions are followed and no modifications of the module are allowed. Additional testing may be required:

- If the host product is subject to electrical appliance safety (for example, powered from an AC mains), the host product may require Product Safety Electrical Appliance and Material (PSE) testing. The integrator should contact their conformance laboratory to determine if this testing is required.
- There is an voluntary Electromagnetic Compatibility (EMC) test for the host product administered by VCCI: http://www.vcci.jp/vcci_e/index.html

8.6.1 LABELING AND USER INFORMATION REQUIREMENTS

The label on the final product which contains the RN4020 module must follow Japan marking requirements. The integrator of the module should refer to the labeling requirements for Japan available at the Ministry of Internal Affairs and Communications (MIC) website.

The RN4020 module is labeled with its own technical conformity mark and certification number. The final product in which this module is being used must have a label referring to the type certified module inside:

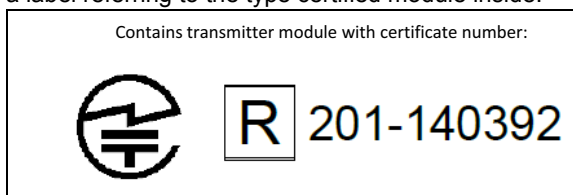

8.6.2 4.6.2 HELPFUL WEB SITES

Ministry of Internal Affairs and Communications (MIC): <http://www.tele.soumu.go.jp/e/index.htm>

Association of Radio Industries and Businesses (ARIB): <http://www.arib.or.jp/english/>

8.7 Korea

The RN4020 module has received certification of conformity in accordance with the Radio Waves Act. Integration of this module into a final product does not require additional radio certification provided installation instructions are followed and no modifications of the module are allowed.

8.7.1 LABELING AND USER INFORMATION REQUIREMENTS

The label on the final product which contains the RN4020 module must follow KC marking requirements. The integrator of the module should refer to the labeling requirements for Korea available on the Korea Communications Commission (KCC) website.

The RN4020 module is labeled with its own KC mark. The final product requires the KC mark and certificate number of the module:

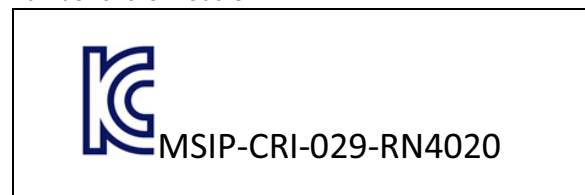

8.7.2 HELPFUL WEB SITES

Korea Communications Commission (KCC): <http://www.kcc.go.kr>

National Radio Research Agency (RRA): <http://rra.go.kr>

RN4020

8.8 Taiwan

The RN4020 module has received compliance approval in accordance with the Telecommunications Act. Customers seeking to use the compliance approval in their product should contact Microchip Technology sales or distribution partners to obtain a Letter of Authority.

Integration of this module into a final product does not require additional radio certification provided installation instructions are followed and no modifications of the module are allowed.

8.8.1 LABELING AND USER INFORMATION REQUIREMENTS

The RN4020 module is labeled with its own NCC mark and certificate number as below:

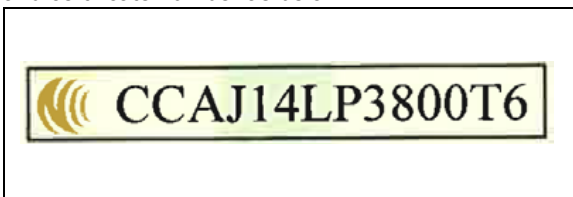

The user's manual should contain below warning (for RF device) in traditional Chinese:

注意！

依據 低功率電波輻射性電機管理辦法

第十二條 經型式認證合格之低功率射頻電機，非經許可，

公司、商號或使用者均不得擅自變更頻率、加大功率或變更原設計之特性及功能。

第十四條 低功率射頻電機之使用不得影響飛航安全及干擾合法通信；

經發現有干擾現象時，應立即停用，並改善至無干擾時方得繼續使用。

前項合法通信，指依電信規定作業之無線電信。

低功率射頻電機須忍受合法通信或工業、科學及醫療用電波輻射性電機設備之干擾。

8.8.2 HELPFUL WEB SITE

National Communications Commission (NCC):
<http://www.ncc.gov.tw>

9.0 ORDERING INFORMATION

Table 9-1 provides ordering information for the RN4020 module.

TABLE 9-1: ORDERING INFORMATION

Part Number	Description
RN4020-V/RM	Standard firmware (GATT, GAP, L2CAP) peripheral and Central mode

Note: For custom applications, contact Microchip representative.

Go to <http://www.microchip.com> for current pricing and a list of distributors carrying Microchip products.

Go to <http://www.microchip.com/RN4020> for latest RN4020 firmware update.

RN4020

NOTES:

APPENDIX A: REVISION HISTORY

Revision A (June 2014)

This is the initial released version of the document in the Microchip format.

Revision B (September 2015)

This revision includes the following updates:

- Updated information for single operating voltage from 3.0V to 3.6V to show 1.8V to 3.6V on page 1.
- Updated [Figure 1-2](#) to change pin names for pin numbers 10, 11, 12, 19, 21 and 22.
- Updated [Figure 1-3](#) to include current inputs and outputs.
- Updated [Table 1-1](#) for changes in pin names, description, and functions.
- Added a Note in [Table 2-1](#).
- Added [Table 2-5](#).
- Added a Note in [Figure 3-1](#).
- Updated [Figure 4-2](#).
- Updated [Figure 4-4](#).
- Updated [Figure 5-1](#).
- Updated [Section 6.0 “ASCII Command API”](#) to add information for GAP Role, MLDP, IO, and Scripting functions.
- Added a Note in [Table 7-1](#).
- Updated [Section 8.0 “Regulatory Approval”](#) to add the regulatory information for Japan, Korea, and Taiwan.
- Minor updates to text and formatting have been incorporated throughout the document.

RN4020

NOTES:

THE MICROCHIP WEB SITE

Microchip provides online support via our WWW site at www.microchip.com. This web site is used as a means to make files and information easily available to customers. Accessible by using your favorite Internet browser, the web site contains the following information:

- **Product Support** – Data sheets and errata, application notes and sample programs, design resources, user's guides and hardware support documents, latest software releases and archived software
- **General Technical Support** – Frequently Asked Questions (FAQ), technical support requests, online discussion groups, Microchip consultant program member listing
- **Business of Microchip** – Product selector and ordering guides, latest Microchip press releases, listing of seminars and events, listings of Microchip sales offices, distributors and factory representatives

CUSTOMER CHANGE NOTIFICATION SERVICE

Microchip's customer notification service helps keep customers current on Microchip products. Subscribers will receive e-mail notification whenever there are changes, updates, revisions or errata related to a specified product family or development tool of interest.

To register, access the Microchip web site at www.microchip.com. Under "Support", click on "Customer Change Notification" and follow the registration instructions.

CUSTOMER SUPPORT

Users of Microchip products can receive assistance through several channels:

- Distributor or Representative
- Local Sales Office
- Field Application Engineer (FAE)
- Technical Support

Customers should contact their distributor, representative or Field Application Engineer (FAE) for support. Local sales offices are also available to help customers. A listing of sales offices and locations is included in the back of this document.

Technical support is available through the web site at: <http://microchip.com/support>

RN4020

NOTES:

Note the following details of the code protection feature on Microchip devices:

- Microchip products meet the specification contained in their particular Microchip Data Sheet.
- Microchip believes that its family of products is one of the most secure families of its kind on the market today, when used in the intended manner and under normal conditions.
- There are dishonest and possibly illegal methods used to breach the code protection feature. All of these methods, to our knowledge, require using the Microchip products in a manner outside the operating specifications contained in Microchip's Data Sheets. Most likely, the person doing so is engaged in theft of intellectual property.
- Microchip is willing to work with the customer who is concerned about the integrity of their code.
- Neither Microchip nor any other semiconductor manufacturer can guarantee the security of their code. Code protection does not mean that we are guaranteeing the product as “unbreakable.”

Code protection is constantly evolving. We at Microchip are committed to continuously improving the code protection features of our products. Attempts to break Microchip's code protection feature may be a violation of the Digital Millennium Copyright Act. If such acts allow unauthorized access to your software or other copyrighted work, you may have a right to sue for relief under that Act.

Information contained in this publication regarding device applications and the like is provided only for your convenience and may be superseded by updates. It is your responsibility to ensure that your application meets with your specifications. MICROCHIP MAKES NO REPRESENTATIONS OR WARRANTIES OF ANY KIND WHETHER EXPRESS OR IMPLIED, WRITTEN OR ORAL, STATUTORY OR OTHERWISE, RELATED TO THE INFORMATION, INCLUDING BUT NOT LIMITED TO ITS CONDITION, QUALITY, PERFORMANCE, MERCHANTABILITY OR FITNESS FOR PURPOSE. Microchip disclaims all liability arising from this information and its use. Use of Microchip devices in life support and/or safety applications is entirely at the buyer's risk, and the buyer agrees to defend, indemnify and hold harmless Microchip from any and all damages, claims, suits, or expenses resulting from such use. No licenses are conveyed, implicitly or otherwise, under any Microchip intellectual property rights unless otherwise stated.

Trademarks

The Microchip name and logo, the Microchip logo, dsPIC, FlashFlex, flexPWR, JukeBlox, KEELOQ, KEELOQ logo, Kleer, LANCheck, MediaLB, MOST, MOST logo, MPLAB, OptoLyzer, PIC, PICSTART, PIC³² logo, RightTouch, SpyNIC, SST, SST Logo, SuperFlash and UNI/O are registered trademarks of Microchip Technology Incorporated in the U.S.A. and other countries.

The Embedded Control Solutions Company and mTouch are registered trademarks of Microchip Technology Incorporated in the U.S.A.

Analog-for-the-Digital Age, BodyCom, chipKIT, chipKIT logo, CodeGuard, dsPICDEM, dsPICDEM.net, ECAN, In-Circuit Serial Programming, ICSP, Inter-Chip Connectivity, KleerNet, KleerNet logo, MiWi, motorBench, MPASM, MPF, MPLAB Certified logo, MPLIB, MPLINK, MultiTRAK, NetDetach, Omniscient Code Generation, PICDEM, PICDEM.net, PICKit, PICTail, RightTouch logo, REAL ICE, SQI, Serial Quad I/O, Total Endurance, TSHARC, USBCheck, VariSense, ViewSpan, WiperLock, Wireless DNA, and ZENA are trademarks of Microchip Technology Incorporated in the U.S.A. and other countries.

SQTP is a service mark of Microchip Technology Incorporated in the U.S.A.

Silicon Storage Technology is a registered trademark of Microchip Technology Inc. in other countries.

GestIC is a registered trademark of Microchip Technology Germany II GmbH & Co. KG, a subsidiary of Microchip Technology Inc., in other countries.

All other trademarks mentioned herein are property of their respective companies.

© 2014-2015, Microchip Technology Incorporated, Printed in the U.S.A., All Rights Reserved.

ISBN: 978-1-63277-793-5

QUALITY MANAGEMENT SYSTEM
CERTIFIED BY DNV
== ISO/TS 16949 ==

Microchip received ISO/TS-16949:2009 certification for its worldwide headquarters, design and wafer fabrication facilities in Chandler and Tempe, Arizona; Gresham, Oregon and design centers in California and India. The Company's quality system processes and procedures are for its PIC® MCUs and dsPIC® DSCs, KEELOQ® code hopping devices, Serial EEPROMs, microperipherals, nonvolatile memory and analog products. In addition, Microchip's quality system for the design and manufacture of development systems is ISO 9001:2000 certified.



MICROCHIP

Worldwide Sales and Service

AMERICAS

Corporate Office
2355 West Chandler Blvd.
Chandler, AZ 85224-6199
Tel: 480-792-7200
Fax: 480-792-7277
Technical Support:
<http://www.microchip.com/support>
Web Address:
www.microchip.com

Atlanta
Duluth, GA
Tel: 678-957-9614
Fax: 678-957-1455

Austin, TX
Tel: 512-257-3370

Boston
Westborough, MA
Tel: 774-760-0087
Fax: 774-760-0088

Chicago
Itasca, IL
Tel: 630-285-0071
Fax: 630-285-0075

Cleveland
Independence, OH
Tel: 216-447-0464
Fax: 216-447-0643

Dallas
Addison, TX
Tel: 972-818-7423
Fax: 972-818-2924

Detroit
Novi, MI
Tel: 248-848-4000

Houston, TX
Tel: 281-894-5983

Indianapolis
Noblesville, IN
Tel: 317-773-8323
Fax: 317-773-5453

Los Angeles
Mission Viejo, CA
Tel: 949-462-9523
Fax: 949-462-9608

New York, NY
Tel: 631-435-6000

San Jose, CA
Tel: 408-735-9110

Canada - Toronto
Tel: 905-673-0699
Fax: 905-673-6509

ASIA/PACIFIC

Asia Pacific Office
Suites 3707-14, 37th Floor
Tower 6, The Gateway
Harbour City, Kowloon

Hong Kong
Tel: 852-2943-5100
Fax: 852-2401-3431

Australia - Sydney
Tel: 61-2-9868-6733
Fax: 61-2-9868-6755

China - Beijing
Tel: 86-10-8569-7000
Fax: 86-10-8528-2104

China - Chengdu
Tel: 86-28-8665-5511
Fax: 86-28-8665-7889

China - Chongqing
Tel: 86-23-8980-9588
Fax: 86-23-8980-9500

China - Dongguan
Tel: 86-769-8702-9880

China - Hangzhou
Tel: 86-571-8792-8115
Fax: 86-571-8792-8116

China - Hong Kong SAR
Tel: 852-2943-5100
Fax: 852-2401-3431

China - Nanjing
Tel: 86-25-8473-2460
Fax: 86-25-8473-2470

China - Qingdao
Tel: 86-532-8502-7355
Fax: 86-532-8502-7205

China - Shanghai
Tel: 86-21-5407-5533
Fax: 86-21-5407-5066

China - Shenyang
Tel: 86-24-2334-2829
Fax: 86-24-2334-2393

China - Shenzhen
Tel: 86-755-8864-2200
Fax: 86-755-8203-1760

China - Wuhan
Tel: 86-27-5980-5300
Fax: 86-27-5980-5118

China - Xian
Tel: 86-29-8833-7252
Fax: 86-29-8833-7256

ASIA/PACIFIC

China - Xiamen
Tel: 86-592-2388138
Fax: 86-592-2388130

China - Zhuhai
Tel: 86-756-3210040
Fax: 86-756-3210049

India - Bangalore
Tel: 91-80-3090-4444
Fax: 91-80-3090-4123

India - New Delhi
Tel: 91-11-4160-8631
Fax: 91-11-4160-8632

India - Pune
Tel: 91-20-3019-1500

Japan - Osaka
Tel: 81-6-6152-7160
Fax: 81-6-6152-9310

Japan - Tokyo
Tel: 81-3-6880-3770
Fax: 81-3-6880-3771

Korea - Daegu
Tel: 82-53-744-4301
Fax: 82-53-744-4302

Korea - Seoul
Tel: 82-2-554-7200
Fax: 82-2-558-5932 or
82-2-558-5934

Malaysia - Kuala Lumpur
Tel: 60-3-6201-9857
Fax: 60-3-6201-9859

Malaysia - Penang
Tel: 60-4-227-8870
Fax: 60-4-227-4068

Philippines - Manila
Tel: 63-2-634-9065
Fax: 63-2-634-9069

Singapore
Tel: 65-6334-8870
Fax: 65-6334-8850

Taiwan - Hsin Chu
Tel: 886-3-5778-366
Fax: 886-3-5770-955

Taiwan - Kaohsiung
Tel: 886-7-213-7828

Taiwan - Taipei
Tel: 886-2-2508-8600
Fax: 886-2-2508-0102

Thailand - Bangkok
Tel: 66-2-694-1351
Fax: 66-2-694-1350

EUROPE

Austria - Wels
Tel: 43-7242-2244-39
Fax: 43-7242-2244-393

Denmark - Copenhagen
Tel: 45-4450-2828
Fax: 45-4485-2829

France - Paris
Tel: 33-1-69-53-63-20
Fax: 33-1-69-30-90-79

Germany - Dusseldorf
Tel: 49-2129-3766400

Germany - Karlsruhe
Tel: 49-721-625370

Germany - Munich
Tel: 49-89-627-144-0
Fax: 49-89-627-144-44

Italy - Milan
Tel: 39-0331-742611
Fax: 39-0331-466781

Italy - Venice
Tel: 39-049-7625286

Netherlands - Drunen
Tel: 31-416-690399
Fax: 31-416-690340

Poland - Warsaw
Tel: 48-22-3325737

Spain - Madrid
Tel: 34-91-708-08-90
Fax: 34-91-708-08-91

Sweden - Stockholm
Tel: 46-8-5090-4654

UK - Wokingham
Tel: 44-118-921-5800
Fax: 44-118-921-5820

07/14/15