

1A, 2.25MHz, Synchronous Step-Down DC-DC Converter

UM3510S SOT23-6

UM3510DA DFN6 2.0×2.0

General Description

The UM3510 is a high efficiency pulse-width-modulated (PWM) synchronous step-down DC-DC converter with an input voltage range of 2.5V to 6.0V. It provides up to 1000mA output current from a single Li-ion cell. The UM3510 operates at 2.25MHz fixed switching frequency and enters Power Save Mode to maintain high efficiency at light load condition.

For low noise applications, the device can be forced into fixed frequency PWM mode by pulling the MODE pin high.

The UM3510 enters shutdown mode and consumes less than 1μA when EN pin is pulled low. Other features include lower internal reference voltage with 2% accuracy, over temperature protection and over current protection.

The UM3510 is available in SOT23-6 and 2mm×2mm 6-pin DFN packages.

Applications

- Cellular and Smart Phones
- Microprocessors and DSP Core Supplies
- Wireless and DSL Modems
- PDAs, GPS
- WLAN
- Portable Instruments

Features

- High Efficiency: Up to 95%
- 2.25MHz Constant Switching Frequency
- 1000mA Output Current
- Integrated Main Switch and Synchronous Rectifier. No Schottky Diode Required.
- 2.5V to 6.0V Input Voltage Range
- Low Quiescent Current: 56μA
- Thermal Fault Protection
- <1μA Shutdown Current

Typical Application Circuit

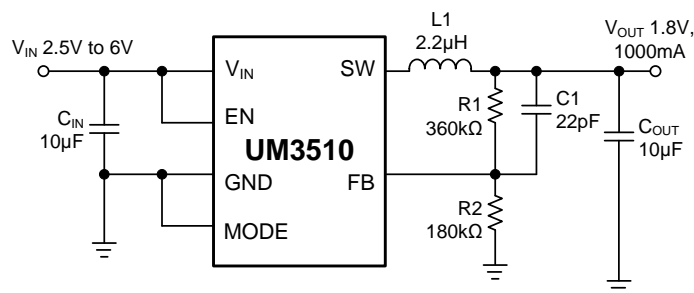

Pin Configurations

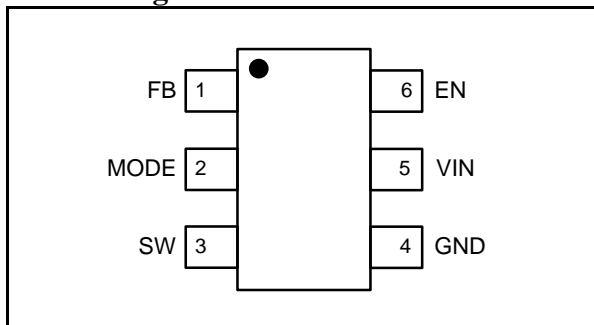

Top View

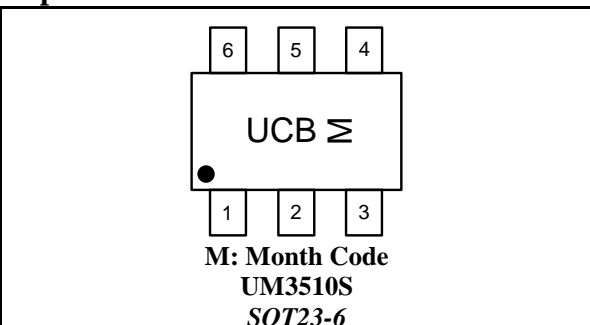

Pin Configurations

Top View

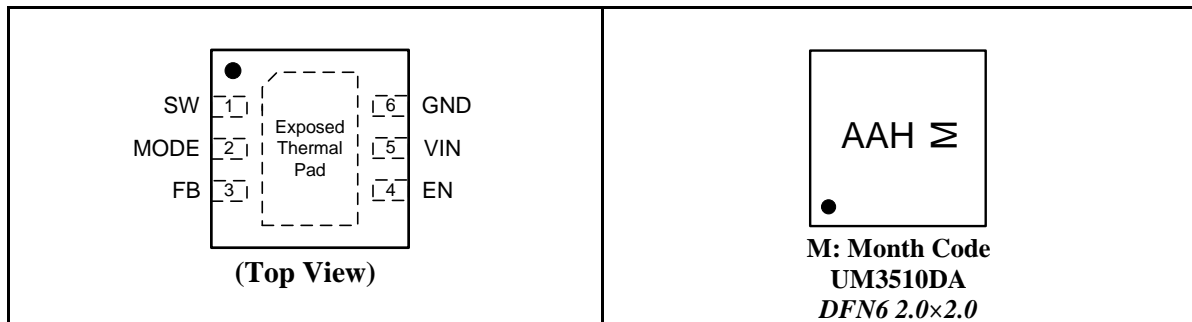

Ordering Information

Part Number	Packaging Type	Marking Code	Shipping Qty
UM3510S	SOT23-6	UCB	3000pcs/7Inch Tape & Reel
UM3510DA	DFN6 2.0x2.0	AAH	

Pin Description

Pin Number		Symbol	Function
SOT23-6	DFN6 2.0x2.0		
3	1	SW	Power switch output. It is the switch node connection to the inductor. This pin connects to the drains of the internal P-CH and N-CH MOSFET switches.
2	2	MODE	MODE pin=high forces the device to operate in fixed-frequency PWM mode. Mode pin=low enables the Power Save Mode with automatic transition from PFM mode to fixed-frequency PWM mode.
1	3	FB	Feedback input pin. Connect FB to the center point of the external resistor divider.
6	4	EN	Regulator enable control input. Pulling this pin to high enables the device. Pulling this pin to low forces the device into shutdown mode. This pin must be terminated.
5	5	VIN	Input voltage.
4	6	GND	Ground.

Absolute Maximum Ratings (Note 1)

Symbol	Parameter	Value	Unit
V_{IN}	Input Voltage	-0.3 to +7.0	V
V_{EN}, V_{FB}	EN, FB Voltages	-0.3 to $V_{IN}+0.3$	V
V_{SW}	SW Voltage	-0.3 to $V_{IN}+0.3$	V
I_{SW}	Peak SW Sink and Source Current	2.0	A
T_O	Operating Temperature	-40 to +85	°C
T_{STG}	Storage Temperature Range	-65 to +150	°C

Note 1: Stresses greater than those listed under Maximum Ratings may cause permanent damage to the device. This is a stress rating only and functional operation of the device at these or any other conditions above those indicated in the operational sections of this specification is not implied. Exposure to absolute maximum rating conditions for extended periods may affect reliability.

Electrical Characteristics
 $(V_{IN}=V_{EN}=3.6V, T_A=+25^{\circ}C, \text{ unless otherwise noted})$

Symbol	Parameter	Test Conditions	Min	Typ	Max	Unit
SUPPLY						
V_{IN}	Input Voltage Range		2.5		6.0	V
UVLO	Under Voltage Lockout Threshold	Falling Edge	1.8		2.3	V
UVLO_HYS	Under Voltage Lockout Hysteresis			200		mV
I_Q	Input DC Supply Current (MODE=GND)	$I_{LOAD}=0mA$		56	80	μA
	Input DC Supply Current (MODE=VIN)	$I_{LOAD}=0mA$		5.6		mA
I_{SD}	Input Supply Current (Shutdown Mode)	$V_{FB}=0V, V_{IN}=6.0V$		0.1	1.0	μA
OUTPUT						
V_{FB}	Regulated Feedback Voltage	$T_A=+25^{\circ}C$	0.588	0.600	0.612	V
I_{FB}	FB Input Bias Current	$V_{FB}=0.65V$			30	nA
	Output Voltage Line Regulation	$2.5V \leq V_{IN} \leq 6.0V,$ $I_{OUT}=10mA,$ MODE=VIN/GND		0.10	0.20	%/V
	Output Voltage Load Regulation	$0.1A \leq I_{OUT} \leq 1A$		0.5		%/A
$I_{O(MAX)}$	Maximum Output Current		1000			mA
t_{SS}	Soft Start Time			400		μs
I_{SWL}	SW Leakage	$V_{EN}=0V, V_{IN}=6V,$ $V_{SW}=0V \text{ or } 6V$		± 0.01	± 1	μA
POWER SWITCH						
$R_{DS(ON)}$	$R_{DS(ON)}$ of P-CH MOSFET	$V_{IN}=3.6V,$ $I_{SW}=100mA$		0.25	0.30	Ω
	$R_{DS(ON)}$ of N-CH MOSFET	$V_{IN}=3.6,$ $I_{SW}=-100mA$		0.18	0.23	Ω
I_P	Peak Inductor Current	$V_{IN}=2.5V \text{ to } 6.0V$	1.6	1.8	2.0	A
	Thermal Shutdown Temperature			150		$^{\circ}C$
	Thermal Shutdown Temperature Hysteresis			20		$^{\circ}C$
OSILLATOR						
f	Oscillator Frequency		1.95	2.25	2.55	MHz
ENABLE, MODE						
V_{IH}	High-Level Threshold		1.2			V
V_{IL}	Low-Level Threshold				0.4	V
I_I	Input Leakage Current			0.1	1	μA

Typical Operating Characteristics

Efficiency vs. Load Current
 $V_{OUT}=1.8V$, Power Save Mode

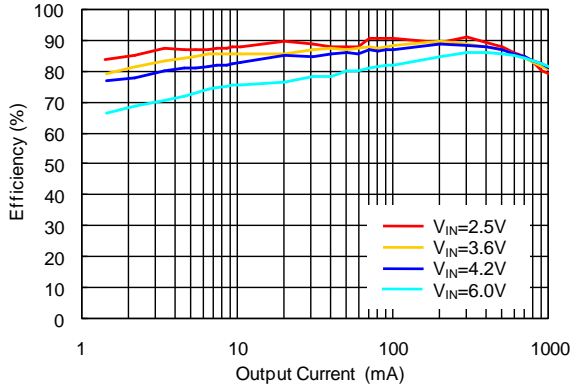

Efficiency vs. Load Current
 $V_{OUT}=1.8V$, Forced PWM Mode

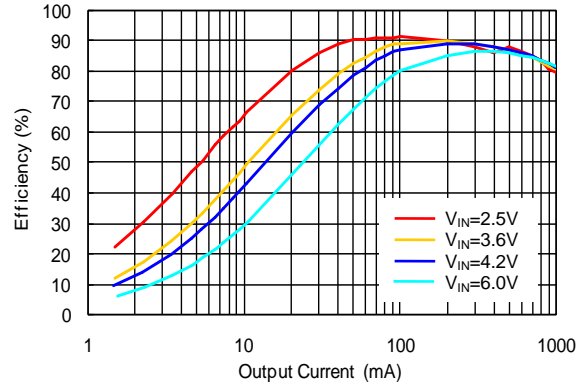

Efficiency vs. Load Current
 $V_{OUT}=3.3V$, Power Save Mode

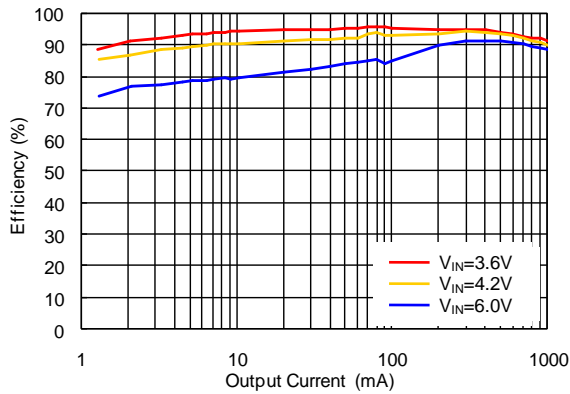

Efficiency vs. Load Current
 $V_{OUT}=3.3V$, Forced PWM Mode

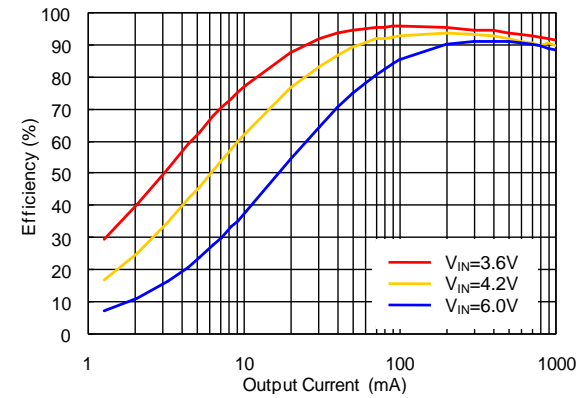

Output Voltage vs. Load Current
 $V_{OUT}=1.8V$, MODE=L

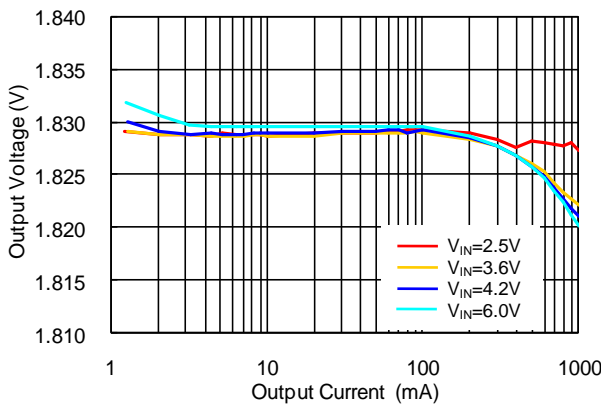

Output Voltage vs. Load Current
 $V_{OUT}=1.8V$, MODE=H

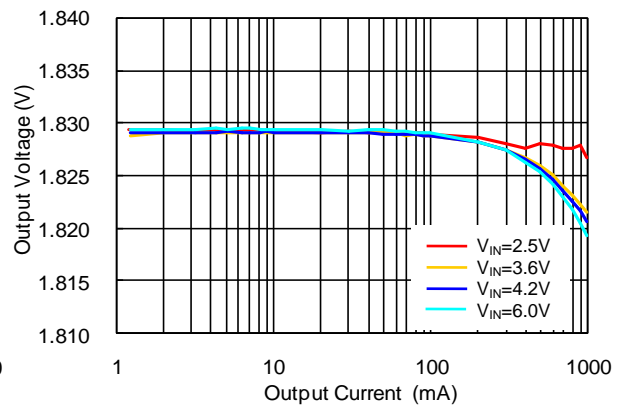

Typical Operating Characteristics (Continued)

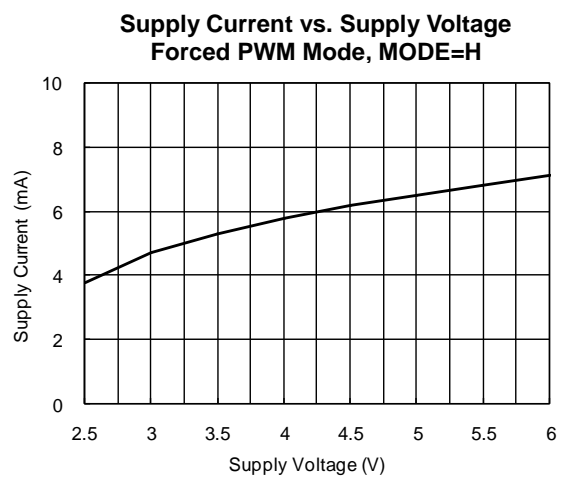
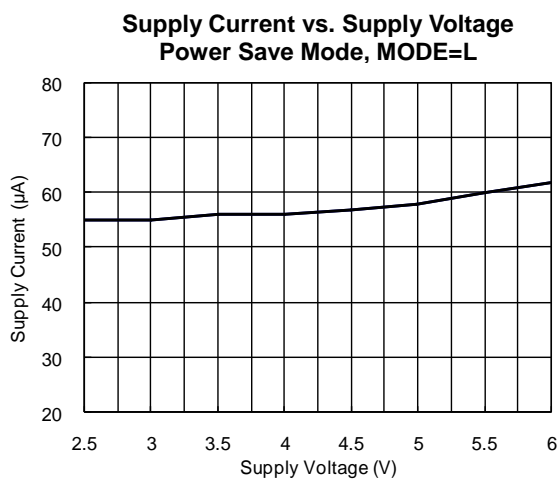
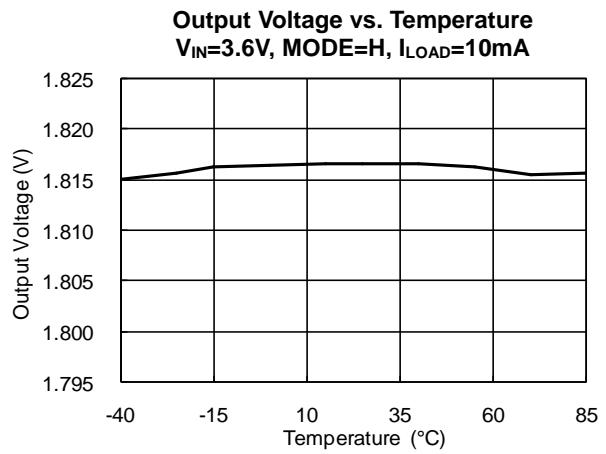
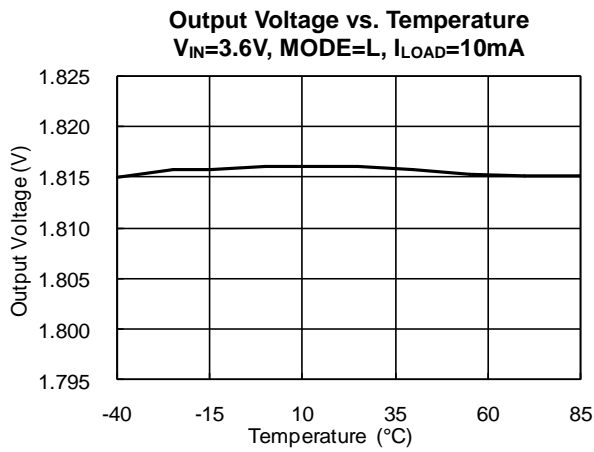
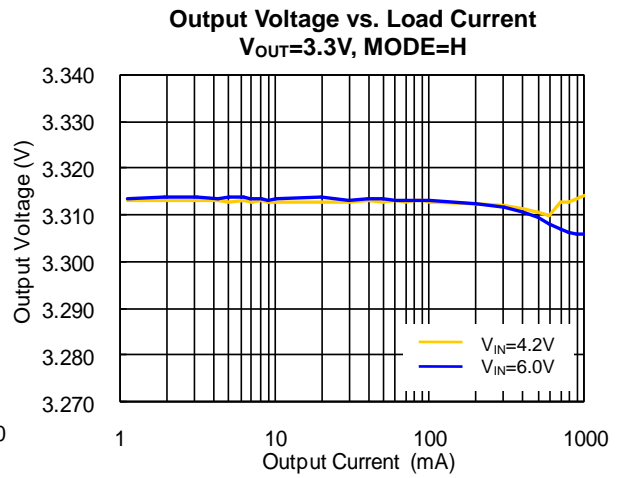
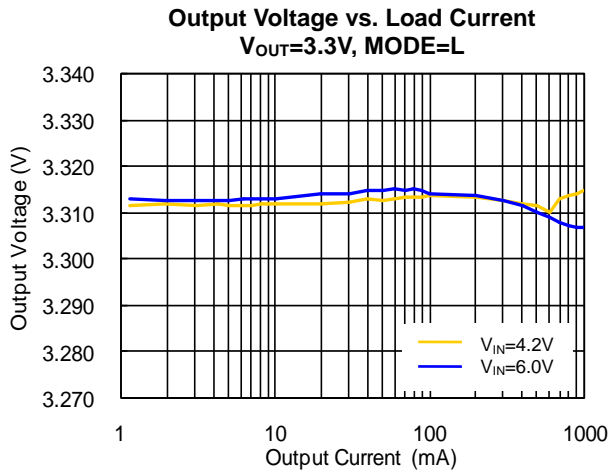

Typical Operating Characteristics (Continued)

Supply Current vs. Temperature
 $V_{IN}=6V, MODE=L$

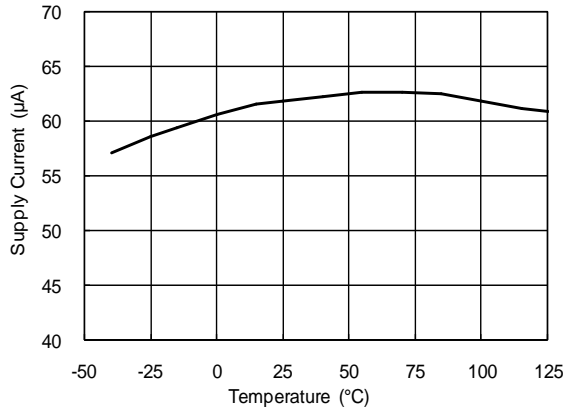

Frequency vs. Supply Voltage
 $V_{OUT}=1.8V, I_{LOAD}=200mA$

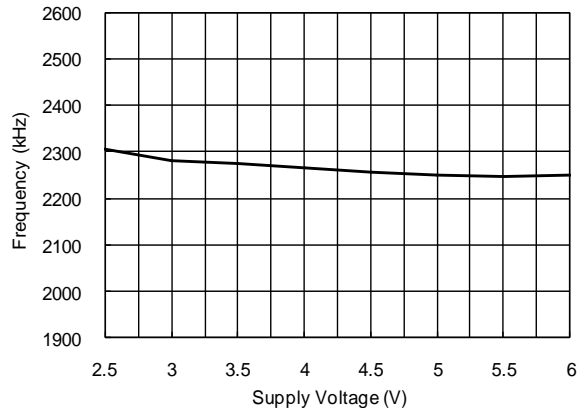

L-Side $R_{DS(ON)}$ vs. Input Voltage

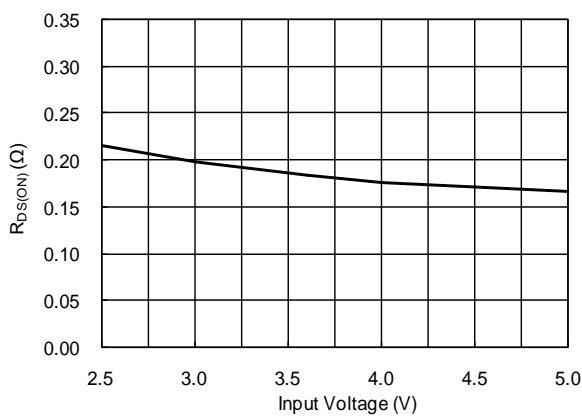

H-Side $R_{DS(ON)}$ vs. Input Voltage

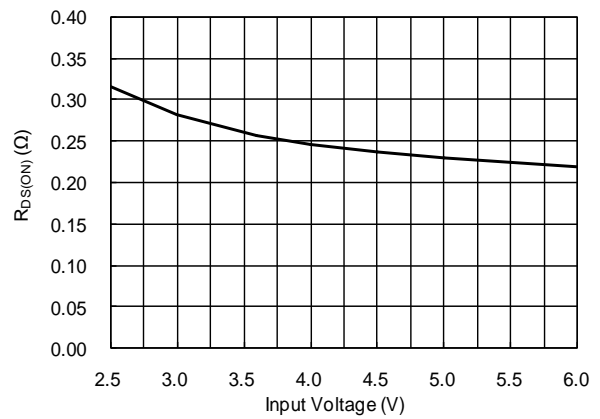

Typical Operating Characteristics (Continued)

Load Transient Response

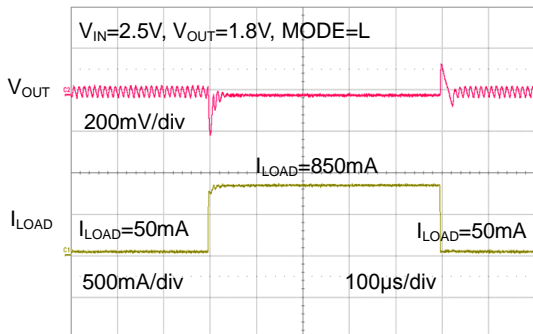

Load Transient Response

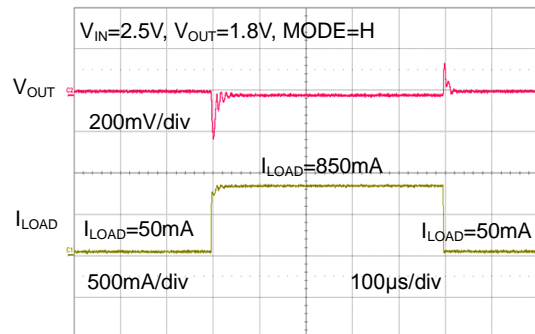

Line Transient Response

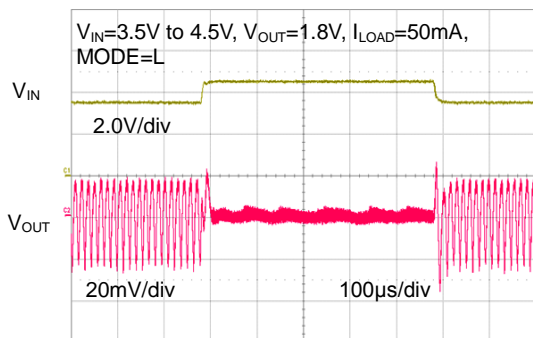

Line Transient Response

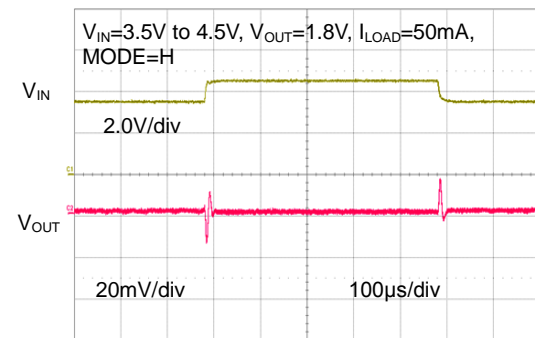

PFM Mode Operation

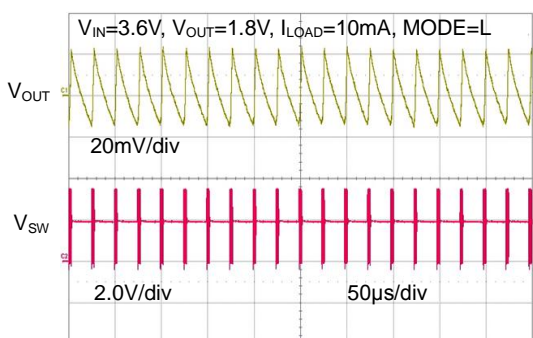

PWM Mode Operation

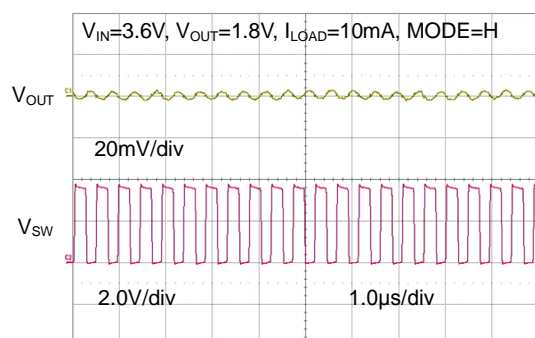

Application Information

Output Voltage Setting

The output voltage can be calculated according to the formula below with an internal reference voltage V_{REF} typical 0.6V:

$$V_{OUT} = V_{REF} \times \left(1 + \frac{R1}{R2}\right)$$

To minimize the current through the feedback divider network, the recommended value of R2 is about 180kΩ. The sum of R1 and R2 should not exceed about 1MΩ to keep the network robust against noise. An external feed forward capacitor C1 is required for optimum load transient response. The value of C1 should be in the range between 10pF and 33pF.

Route the FB line away from noise sources, such as the inductor or the SW line.

Inductor Selection

A 1μH to 10μH inductor with DC current rating at least 25% higher than the maximum load current is recommended for most applications. For best efficiency, the inductor DC resistance shall be <200mΩ.

For most designs, the inductance value can be derived from the following equation:

$$L = \frac{V_{OUT} \times (V_{IN} - V_{OUT})}{V_{IN} \times \Delta I_L \times f_{OSC}}$$

Where ΔI_L is the inductor ripple current. Choose inductor ripple current approximately 30% of the maximum load current, 1000mA.

The maximum inductor peak current is:

$$I_{L(MAX)} = I_{LOAD} + \frac{\Delta I_L}{2}$$

The following table is a list of recommended inductors.

List of Recommended Inductors

Dimension [mm ³]	Inductor Type	Supplier
4.5×4×3.2	744773022	Würth Elektronik
3×3×1.5	LQH3NPN2R2NM0	MURATA
3×3×1.5	LPS3015	Coilcraft

Input Capacitor Selection

The input capacitor reduces the surge current drawn from the input and switching noise from the device. The input capacitor impedance at the switching frequency shall be less than the input source impedance to prevent high frequency switching current passing to the input. Ceramic capacitors with X5R or X7R dielectrics are highly recommended because of their low ESR and small temperature coefficients. For most applications, a 10μF capacitor is sufficient. The input capacitor can be increased without any limit for better input voltage filtering.

Output Capacitor Selection

The output capacitor keeps output voltage ripple small and ensures regulation loop stable. The output capacitor impedance shall be low at the switching frequency. Ceramic capacitor with X5R or X7R dielectrics are recommended. The output ripple ΔV_{OUT} is approximately:

$$\Delta V_{OUT} \leq \frac{V_{OUT} \times (V_{IN} - V_{OUT})}{V_{IN} \times f_{OSC} \times L} \times \left(ESR + \frac{1}{8 \times f_{OSC} \times C_{OUT}}\right)$$

Layout Guidance

When laying out the PC board, the following suggestions should be taken to ensure proper operation of the UM3510.

1. The power traces, including the GND trace, the SW trace and the VIN trace should be kept short, direct and wide to allow large current flow.
2. Connect the input capacitor C_{IN} to the VIN pin as closely as possible to get good power filter effect.
3. Keep the switching node, SW, away from the sensitive FB node.
4. Do not trace signal line under inductor.

Package Information

UM3510S: SOT23-6

Outline Drawing

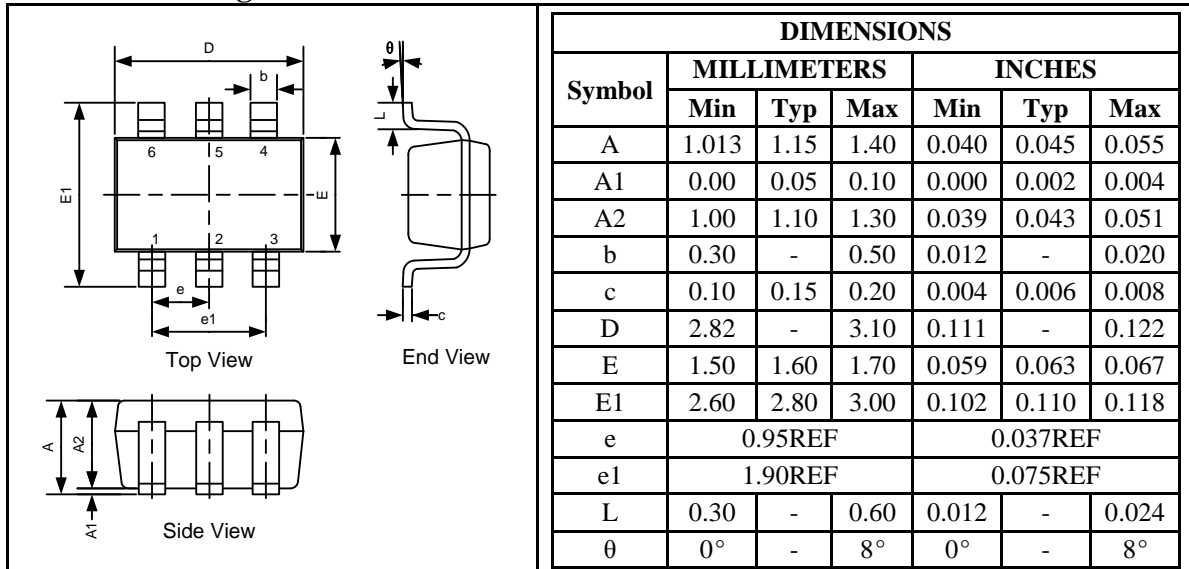

Land Pattern

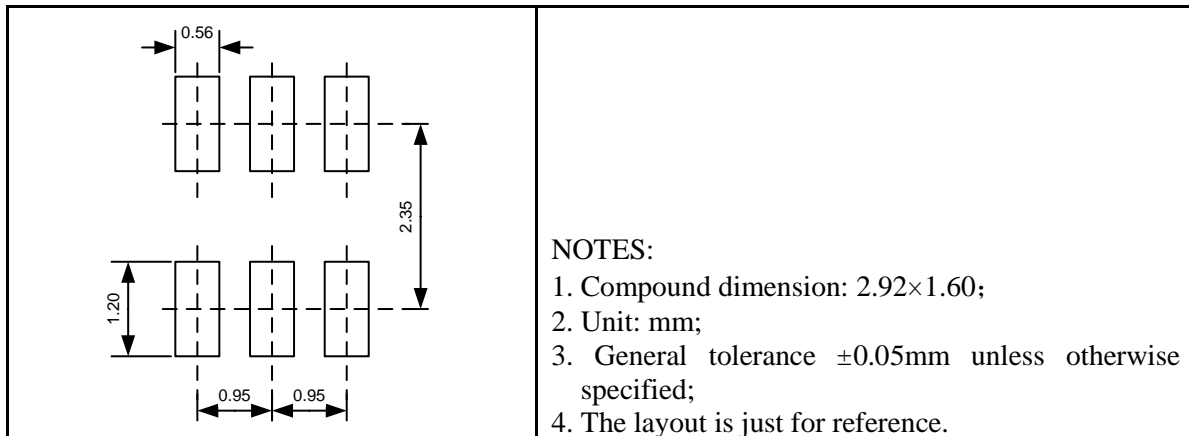

Tape and Reel Orientation



UM3510DA DFN6 2.0×2.0

Outline Drawing

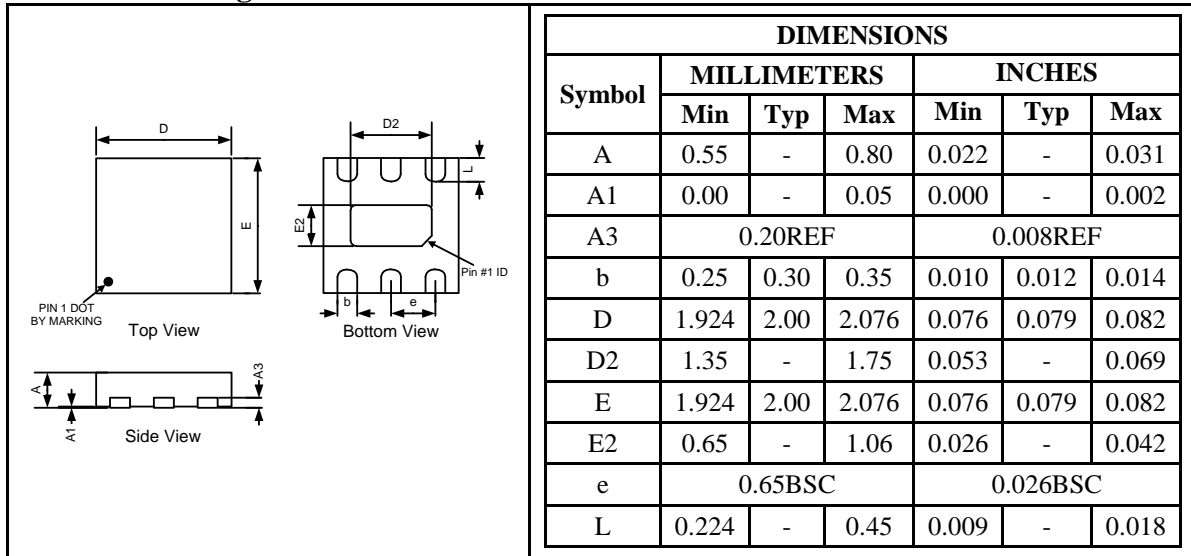

Land Pattern

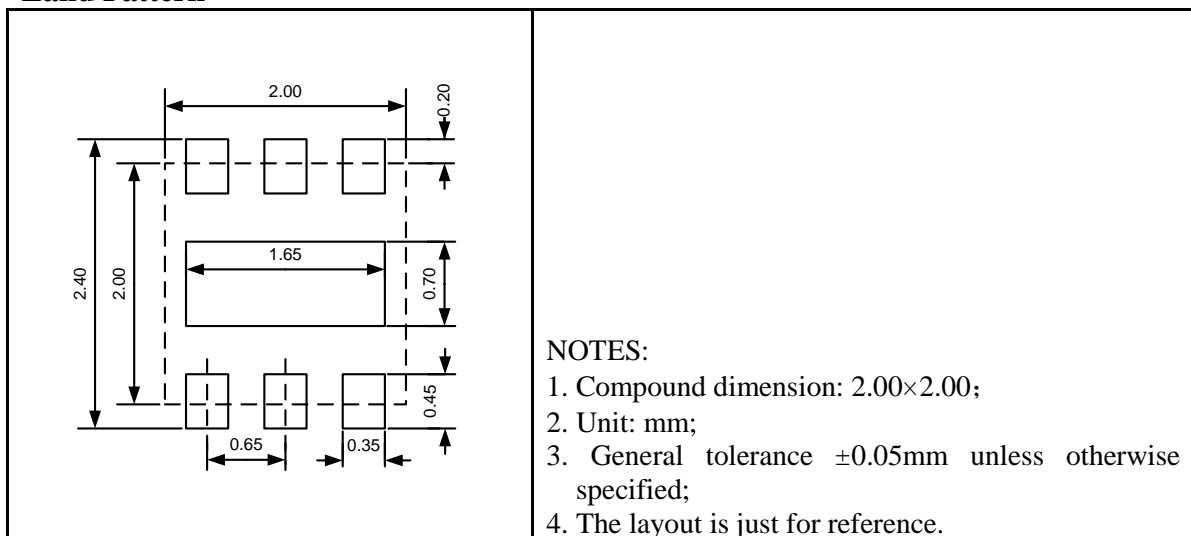

Tape and Reel Orientation



GREEN COMPLIANCE

Union Semiconductor is committed to environmental excellence in all aspects of its operations including meeting or exceeding regulatory requirements with respect to the use of hazardous substances. Numerous successful programs have been implemented to reduce the use of hazardous substances and/or emissions.

All Union components are compliant with the RoHS directive, which helps to support customers in their compliance with environmental directives. For more green compliance information, please visit:

http://www.union-ic.com/index.aspx?cat_code=RoHSDeclaration

IMPORTANT NOTICE

The information in this document has been carefully reviewed and is believed to be accurate. Nonetheless, this document is subject to change without notice. Union assumes no responsibility for any inaccuracies that may be contained in this document, and makes no commitment to update or to keep current the contained information, or to notify a person or organization of any update. Union reserves the right to make changes, at any time, in order to improve reliability, function or design and to attempt to supply the best product possible.



Union Semiconductor, Inc

Add: Unit 606, No.570 Shengxia Road, Shanghai 201210

Tel: 021-51093966

Fax: 021-51026018

Website: www.union-ic.com