

IRF3710

HEXFET® Power MOSFET

- Advanced Process Technology
- Ultra Low On-Resistance
- Dynamic dv/dt Rating
- 175°C Operating Temperature
- Fast Switching
- Fully Avalanche Rated

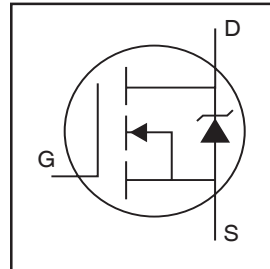

$V_{DSS} = 100V$
$R_{DS(on)} = 23m\Omega$
$I_D = 57A$

Description

Advanced HEXFET® Power MOSFETs from International Rectifier utilize advanced processing techniques to achieve extremely low on-resistance per silicon area. This benefit, combined with the fast switching speed and ruggedized device design that HEXFET power MOSFETs are well known for, provides the designer with an extremely efficient and reliable device for use in a wide variety of applications.

The TO-220 package is universally preferred for all commercial-industrial applications at power dissipation levels to approximately 50 watts. The low thermal resistance and low package cost of the TO-220 contribute to its wide acceptance throughout the industry.



Absolute Maximum Ratings

	Parameter	Max.	Units
$I_D @ T_C = 25^\circ C$	Continuous Drain Current, $V_{GS} @ 10V$	57	A
$I_D @ T_C = 100^\circ C$	Continuous Drain Current, $V_{GS} @ 10V$	40	
I_{DM}	Pulsed Drain Current ①	230	
$P_D @ T_C = 25^\circ C$	Power Dissipation	200	W
	Linear Derating Factor	1.3	W/°C
V_{GS}	Gate-to-Source Voltage	± 20	V
I_{AR}	Avalanche Current ①	28	A
E_{AR}	Repetitive Avalanche Energy ①	20	mJ
dv/dt	Peak Diode Recovery dv/dt ③	5.8	V/ns
T_J	Operating Junction and Storage Temperature Range	-55 to + 175	°C
T_{STG}			
	Mounting torque, 6-32 or M3 screw	10 lbf•in (1.1N•m)	

Thermal Resistance

	Parameter	Typ.	Max.	Units
$R_{\theta JC}$	Junction-to-Case	—	0.75	°C/W
$R_{\theta CS}$	Case-to-Sink, Flat, Greased Surface	0.50	—	
$R_{\theta JA}$	Junction-to-Ambient	—	62	

Electrical Characteristics @ T_J = 25°C (unless otherwise specified)

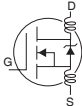
	Parameter	Min.	Typ.	Max.	Units	Conditions
V _{(BR)DSS}	Drain-to-Source Breakdown Voltage	100	—	—	V	V _{GS} = 0V, I _D = 250μA
ΔV _{(BR)DSS} /ΔT _J	Breakdown Voltage Temp. Coefficient	—	0.13	—	V/°C	Reference to 25°C, I _D = 1mA
R _{DS(on)}	Static Drain-to-Source On-Resistance	—	—	23	mΩ	V _{GS} = 10V, I _D = 28A ④
V _{GS(th)}	Gate Threshold Voltage	2.0	—	4.0	V	V _{DS} = V _{GS} , I _D = 250μA
g _{fs}	Forward Transconductance	32	—	—	S	V _{DS} = 25V, I _D = 28A④
I _{DSS}	Drain-to-Source Leakage Current	—	—	25	μA	V _{DS} = 100V, V _{GS} = 0V
		—	—	250		V _{DS} = 80V, V _{GS} = 0V, T _J = 150°C
I _{GSS}	Gate-to-Source Forward Leakage	—	—	100	nA	V _{GS} = 20V
	Gate-to-Source Reverse Leakage	—	—	-100		V _{GS} = -20V
Q _g	Total Gate Charge	—	—	130	nC	I _D = 28A
Q _{gs}	Gate-to-Source Charge	—	—	26		V _{DS} = 80V
Q _{gd}	Gate-to-Drain ("Miller") Charge	—	—	43		V _{GS} = 10V, See Fig. 6 and 13
t _{d(on)}	Turn-On Delay Time	—	12	—	ns	V _{DD} = 50V
t _r	Rise Time	—	58	—		I _D = 28A
t _{d(off)}	Turn-Off Delay Time	—	45	—		R _G = 2.5Ω
t _f	Fall Time	—	47	—		V _{GS} = 10V, See Fig. 10 ④
L _D	Internal Drain Inductance	—	4.5	—	nH	Between lead, 6mm (0.25in.) from package and center of die contact
L _S	Internal Source Inductance	—	7.5	—		
C _{iss}	Input Capacitance	—	3130	—	pF	V _{GS} = 0V
C _{oss}	Output Capacitance	—	410	—		V _{DS} = 25V
C _{rss}	Reverse Transfer Capacitance	—	72	—		f = 1.0MHz, See Fig. 5
E _{AS}	Single Pulse Avalanche Energy②	—	1060③	280⑥		I _{AS} = 28A, L = 0.70mH

Source-Drain Ratings and Characteristics

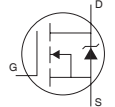
	Parameter	Min.	Typ.	Max.	Units	Conditions
I _S	Continuous Source Current (Body Diode)	—	—	57	A	MOSFET symbol showing the integral reverse p-n junction diode. 
I _{SM}	Pulsed Source Current (Body Diode)①	—	—	230		
V _{SD}	Diode Forward Voltage	—	—	1.2	V	T _J = 25°C, I _S = 28A, V _{GS} = 0V ④
t _{rr}	Reverse Recovery Time	—	140	220	ns	T _J = 25°C, I _F = 28A
Q _{rr}	Reverse Recovery Charge	—	670	1010	nC	di/dt = 100A/μs ④
t _{on}	Forward Turn-On Time	Intrinsic turn-on time is negligible (turn-on is dominated by L _S +L _D)				

Notes:

- ① Repetitive rating; pulse width limited by max. junction temperature. (See fig. 11)
- ② Starting T_J = 25°C, L = 0.70mH
R_G = 25Ω, I_{AS} = 28A, V_{GS} = 10V (See Figure 12)
- ③ I_{SD} ≤ 28A, di/dt ≤ 380A/μs, V_{DD} ≤ V_{(BR)DSS},
T_J ≤ 175°C
- ④ Pulse width ≤ 400μs; duty cycle ≤ 2%.
- ⑤ This is a typical value at device destruction and represents operation outside rated limits.
- ⑥ This is a calculated value limited to T_J = 175°C .

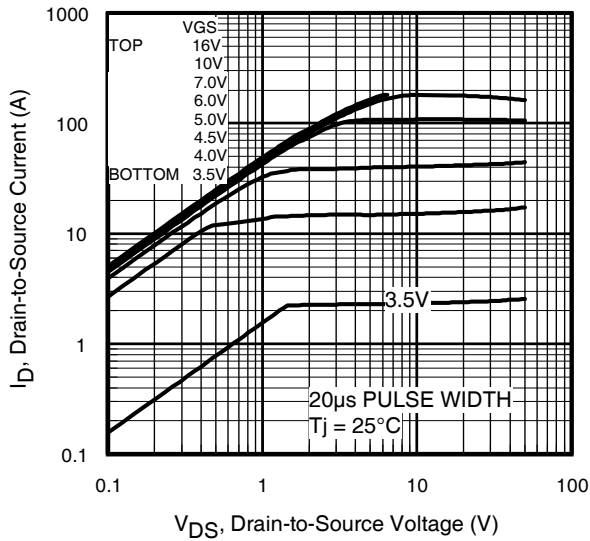

Fig 1. Typical Output Characteristics

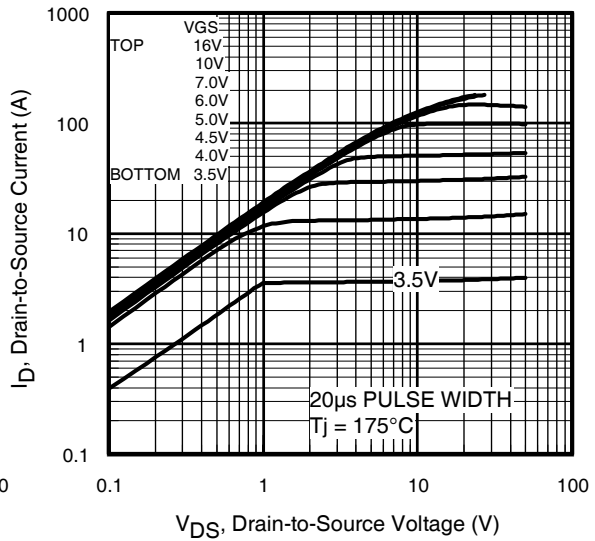

Fig 2. Typical Output Characteristics

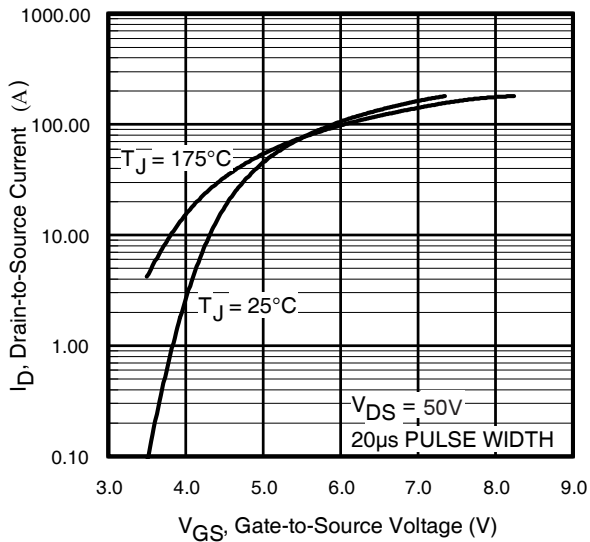

Fig 3. Typical Transfer Characteristics

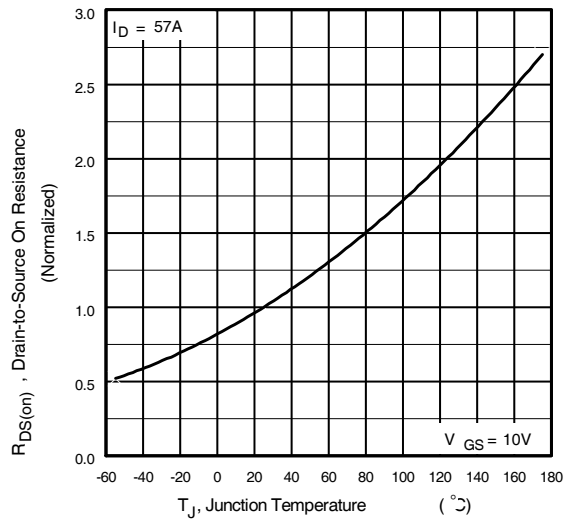

Fig 4. Normalized On-Resistance Vs. Temperature

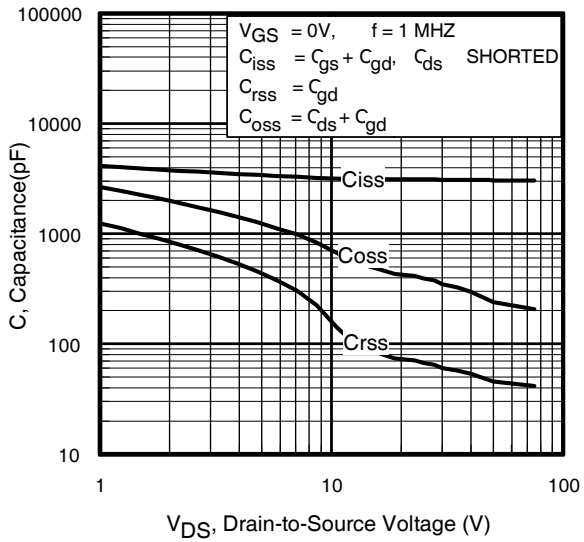

Fig 5. Typical Capacitance Vs. Drain-to-Source Voltage

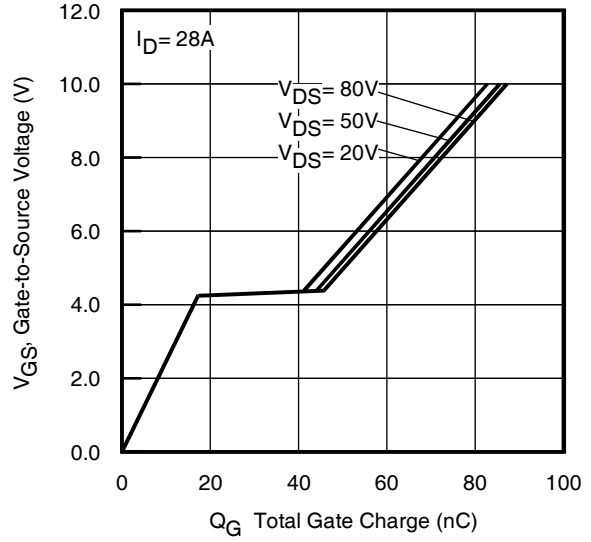

Fig 6. Typical Gate Charge Vs. Gate-to-Source Voltage

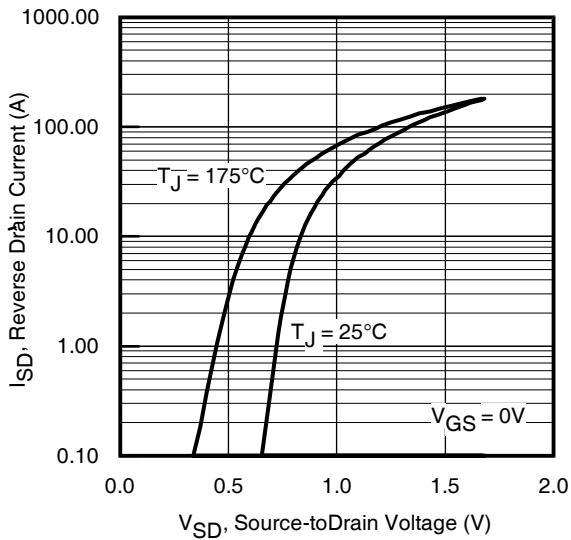

Fig 7. Typical Source-Drain Diode Forward Voltage

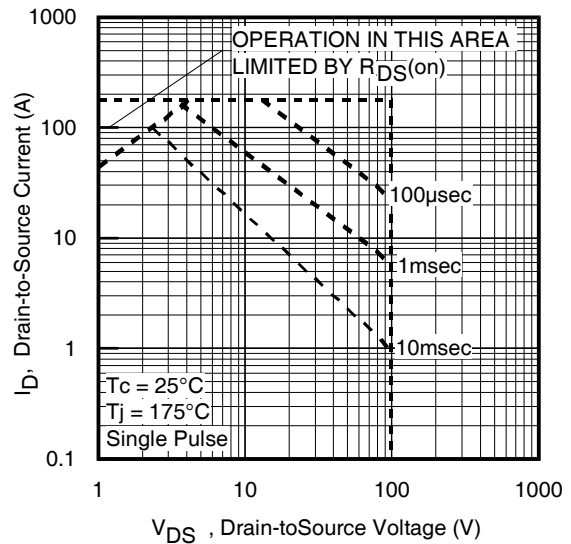

Fig 8. Maximum Safe Operating Area

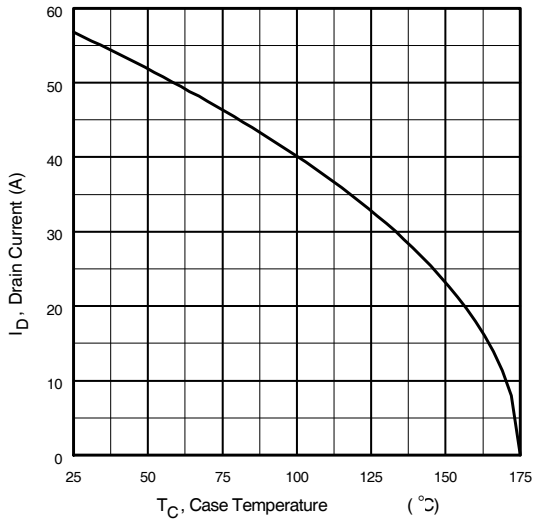

Fig 9. Maximum Drain Current Vs. Case Temperature



Fig 10a. Switching Time Test Circuit



Fig 10b. Switching Time Waveforms

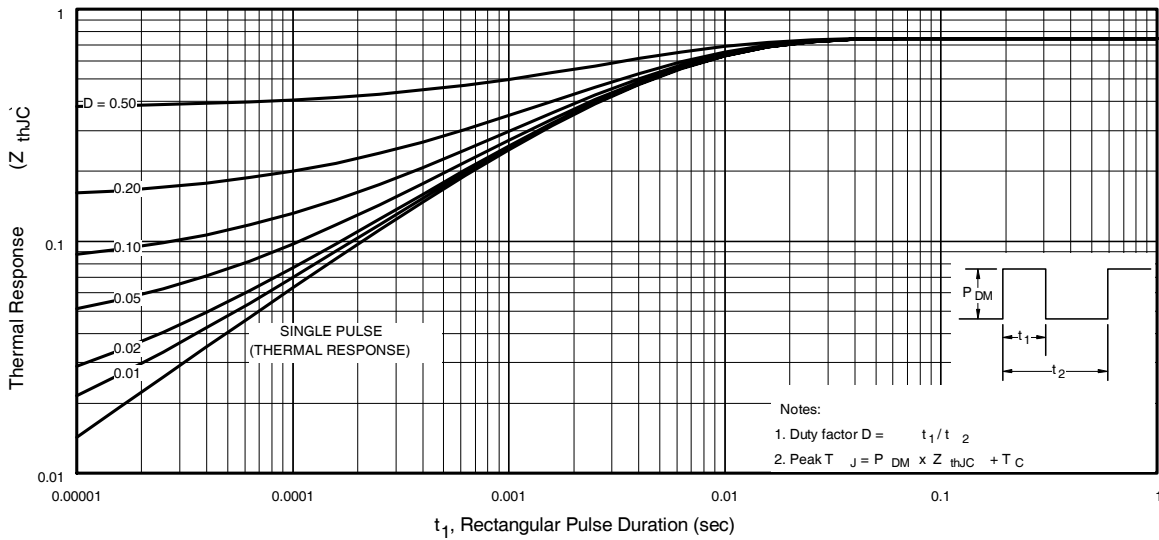

Fig 11. Maximum Effective Transient Thermal Impedance, Junction-to-Case

IRF3710

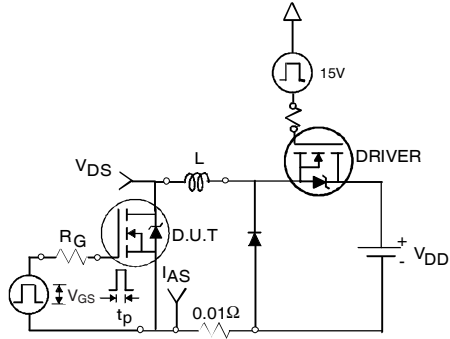

Fig 12a. Unclamped Inductive Test Circuit



Fig 12b. Unclamped Inductive Waveforms

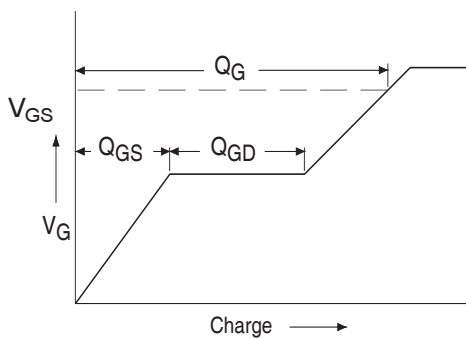

Fig 13a. Basic Gate Charge Waveform

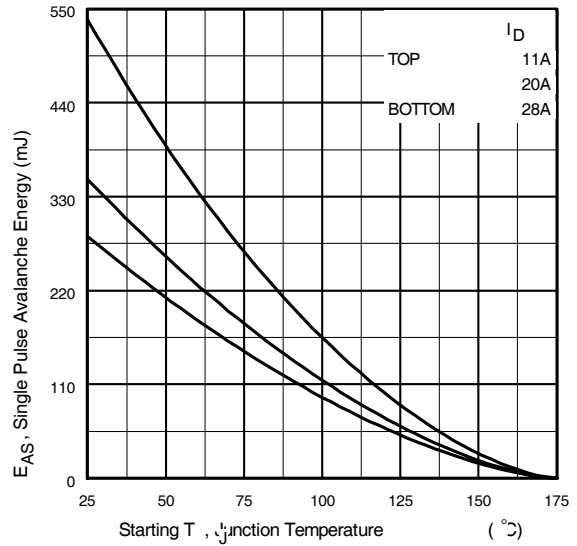
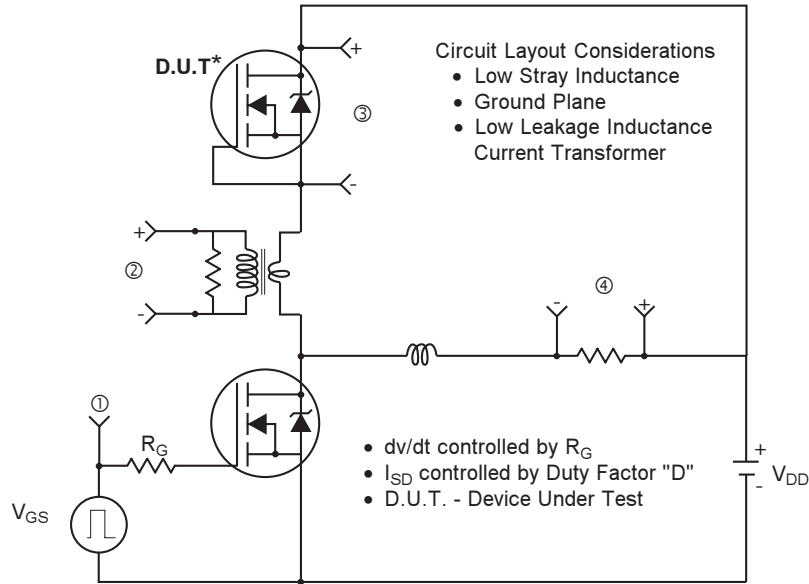

Fig 12c. Maximum Avalanche Energy Vs. Drain Current



Fig 13b. Gate Charge Test Circuit

Peak Diode Recovery dv/dt Test Circuit



* Reverse Polarity of D.U.T for P-Channel



*** $V_{GS} = 5.0V$ for Logic Level and 3V Drive Devices

Fig 14. For N-channel HEXFET® power MOSFETs

IRF3710

TO-220AB Package Outline

Dimensions are shown in millimeters (inches)

International
IR Rectifier

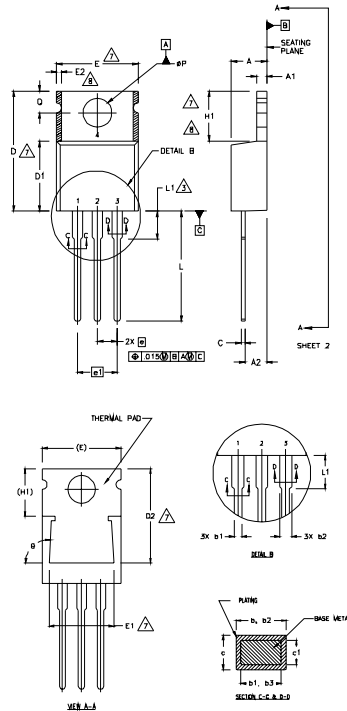

NOTES:

- 1 DIMENSIONING AND TOLERANCING PER ASME Y14.5 M- 1994.
- 2 DIMENSIONS ARE SHOWN IN INCHES (MILLIMETERS).
- 3 LEAD DIMENSION AND FINISH UNCONTROLLED IN L1.
- 4 DIMENSION D & E DO NOT INCLUDE MOLD FLASH. MOLD FLASH SHALL NOT EXCEED .008" (0.127) PER SIDE. THESE DIMENSIONS ARE MEASURED AT THE OUTERMOST EXTREMES OF THE PLASTIC BODY.
- 5 DIMENSION b1 & c1 APPLY TO BASE METAL ONLY.
- 6 CONTROLLING DIMENSION - INCHES.
- 7 THERMAL PAD CONTOUR OPTIONAL WITHIN DIMENSIONS E,H1,D2 & E1 AND SINGULATION IRREGULARITIES ARE ALLOWED.
- 8 DIMENSION E2 X H1 DEFINE A ZONE WHERE STAMPING AND SINGULATION IRREGULARITIES ARE ALLOWED.

LEAD ASSIGNMENTS

- KEY:**
1 - GATE
2 - DRAIN
3 - SOURCE

IRF3710 CATHODE

- 1 - GATE
2 - COLLECTOR
3 - EMITTER

DIODES

- 1 - ANODE/OPEN
2 - CATHODE
3 - ANODE

SYMBOL	DIMENSIONS				NOTES
	MILLIMETERS		INCHES		
	MIN.	MAX.	MIN.	MAX.	
A	3.56	4.82	.140	.190	
A1	0.51	1.40	.020	.055	
A2	2.04	2.92	.080	.115	
b	0.38	1.01	.015	.040	
b1	0.38	0.96	.015	.038	5
b2	1.15	1.77	.045	.070	
b3	1.15	1.73	.045	.068	
c	0.36	0.61	.014	.024	
c1	0.36	0.56	.014	.022	5
D	14.22	16.51	.560	.650	4
D1	8.38	9.02	.330	.355	
D2	12.19	12.88	.480	.507	7
E	9.66	10.66	.380	.420	4,7
E1	8.38	8.89	.330	.350	7
e	2.54 BSC		100 BSC		
e1	5.08		200 BSC		
H1	5.85	6.55	.230	.270	7,8
L	12.70	14.73	.500	.580	
L1		6.35		.250	
aP	3.54	4.08	.139	.161	3
Q	2.54	3.42	.100	.135	
ø	90°-93°		90°-93°		

TO-220AB Part Marking Information

EXAMPLE: THIS IS AN IRF1010
 LOT CODE 1789
 ASSEMBLED ON WW 19, 1997
 IN THE ASSEMBLY LINE 'C'
Note: "P" in assembly line position indicates "Lead-Free"

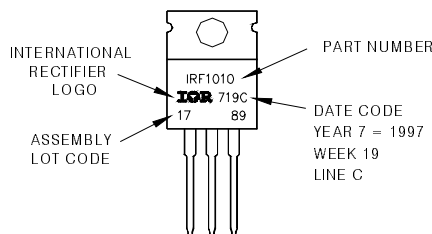

Note: For the most current drawing please refer to IR website at <http://www.irf.com/package/>

Data and specifications subject to change without notice.
 This product has been designed and qualified for the Automotive [Q101] market.
 Qualification Standards can be found on IR's Web site.

International
IR Rectifier

IR WORLD HEADQUARTERS: 233 Kansas St., El Segundo, California 90245, USA Tel: (310) 252-7105
 TAC Fax: (310) 252-7903

Visit us at www.irf.com for sales contact information.09/2009

www.irf.com