

IRF7324

HEXFET® Power MOSFET

- Trench Technology
- Ultra Low On-Resistance
- Dual P-Channel MOSFET
- Low Profile (<1.1mm)
- Available in Tape & Reel
- 2.5V Rated

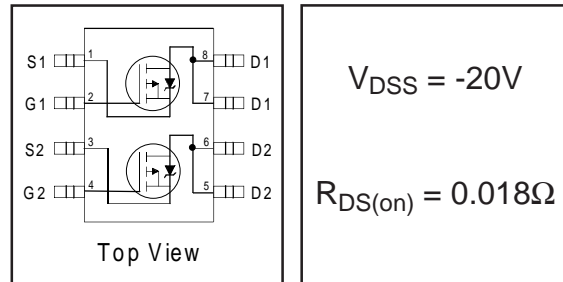

$V_{DSS} = -20V$
 $R_{DS(on)} = 0.018\Omega$

Description

New trench HEXFET® Power MOSFETs from International Rectifier utilize advanced processing techniques to achieve extremely low on-resistance per silicon area. This benefit, combined with the ruggedized device design that HEXFET power MOSFETs are well known for, provides the designer with an extremely efficient and reliable device for use in battery and load management applications.

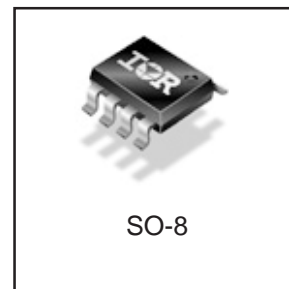

Absolute Maximum Ratings

	Parameter	Max.	Units
V_{DS}	Drain-Source Voltage	-20	V
$I_D @ T_A = 25^\circ C$	Continuous Drain Current, $V_{GS} @ -4.5V$	-9.0	A
$I_D @ T_A = 70^\circ C$	Continuous Drain Current, $V_{GS} @ -4.5V$	-7.1	
I_{DM}	Pulsed Drain Current ^①	-71	
$P_D @ T_A = 25^\circ C$	Maximum Power Dissipation ^③	2.0	W
$P_D @ T_A = 70^\circ C$	Maximum Power Dissipation ^③	1.3	W
	Linear Derating Factor	16	mW/°C
V_{GS}	Gate-to-Source Voltage	± 12	V
T_J, T_{STG}	Junction and Storage Temperature Range	-55 to + 150	°C

Thermal Resistance

	Parameter	Max.	Units
$R_{\theta JA}$	Maximum Junction-to-Ambient ^③	62.5	°C/W

Electrical Characteristics @ $T_J = 25^\circ\text{C}$ (unless otherwise specified)

	Parameter	Min.	Typ.	Max.	Units	Conditions
$V_{(BR)DSS}$	Drain-to-Source Breakdown Voltage	-20	—	—	V	$V_{GS} = 0V, I_D = -250\mu A$
$\Delta V_{(BR)DSS}/\Delta T_J$	Breakdown Voltage Temp. Coefficient	—	-0.02	—	V/°C	Reference to $25^\circ\text{C}, I_D = -1\text{mA}$
$R_{DS(on)}$	Static Drain-to-Source On-Resistance	—	—	0.018	Ω	$V_{GS} = -4.5V, I_D = -9.0A$ ②
		—	—	0.026		$V_{GS} = -2.5V, I_D = -7.7A$ ②
$V_{GS(th)}$	Gate Threshold Voltage	-0.45	—	-1.0	V	$V_{DS} = V_{GS}, I_D = -250\mu A$
g_{fs}	Forward Transconductance	19	—	—	S	$V_{DS} = -10V, I_D = -9.0A$
I_{DSS}	Drain-to-Source Leakage Current	—	—	-1.0	μA	$V_{DS} = -16V, V_{GS} = 0V$
		—	—	-25		$V_{DS} = -16V, V_{GS} = 0V, T_J = 125^\circ\text{C}$
I_{GSS}	Gate-to-Source Forward Leakage	—	—	-100	nA	$V_{GS} = -12V$
	Gate-to-Source Reverse Leakage	—	—	100		$V_{GS} = 12V$
Q_g	Total Gate Charge	—	42	63	nC	$I_D = -9.0A$
Q_{gs}	Gate-to-Source Charge	—	7.1	11		$V_{DS} = -16V$
Q_{gd}	Gate-to-Drain ("Miller") Charge	—	12	18		$V_{GS} = -5.0V$
$t_{d(on)}$	Turn-On Delay Time	—	17	—	ns	$V_{DD} = -10V$
t_r	Rise Time	—	36	—		$I_D = -1.0A$
$t_{d(off)}$	Turn-Off Delay Time	—	170	—		$R_G = 6.0\Omega$
t_f	Fall Time	—	190	—		$R_D = 10\Omega$ ②
C_{iss}	Input Capacitance	—	2940	—	pF	$V_{GS} = 0V$
C_{oss}	Output Capacitance	—	630	—		$V_{DS} = -15V$
C_{rss}	Reverse Transfer Capacitance	—	420	—		$f = 1.0\text{MHz}$

Source-Drain Ratings and Characteristics

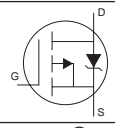
	Parameter	Min.	Typ.	Max.	Units	Conditions
I_S	Continuous Source Current (Body Diode)	—	—	-2.0	A	MOSFET symbol showing the integral reverse p-n junction diode. 
I_{SM}	Pulsed Source Current (Body Diode) ①	—	—	-71		
V_{SD}	Diode Forward Voltage	—	—	-1.2	V	$T_J = 25^\circ\text{C}, I_S = -2.0A, V_{GS} = 0V$ ②
t_{rr}	Reverse Recovery Time	—	180	270	ns	$T_J = 25^\circ\text{C}, I_F = -2.0A$
Q_{rr}	Reverse Recovery Charge	—	300	450	nC	$di/dt = -100A/\mu s$ ②

Notes:

- ① Repetitive rating; pulse width limited by max. junction temperature.
- ② Pulse width $\leq 300\mu s$; duty cycle $\leq 2\%$.
- ③ Surface mounted on FR-4 board, $t \leq 10\text{sec}$.

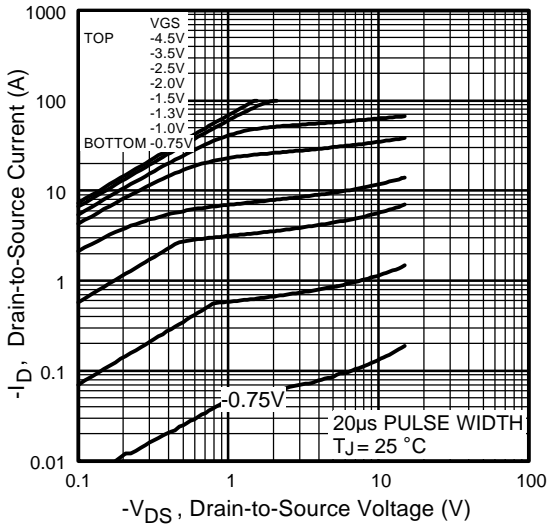

Fig 1. Typical Output Characteristics

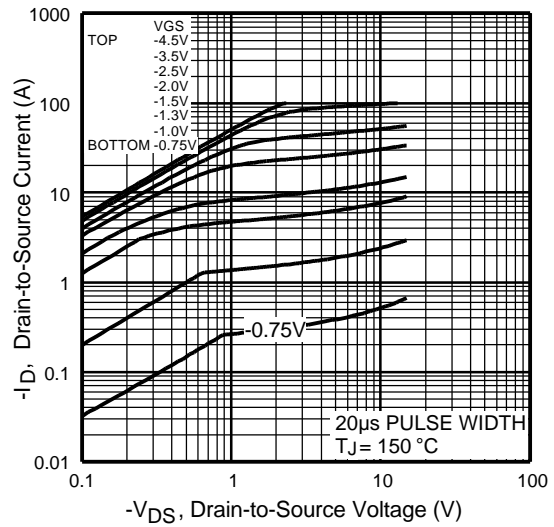

Fig 2. Typical Output Characteristics

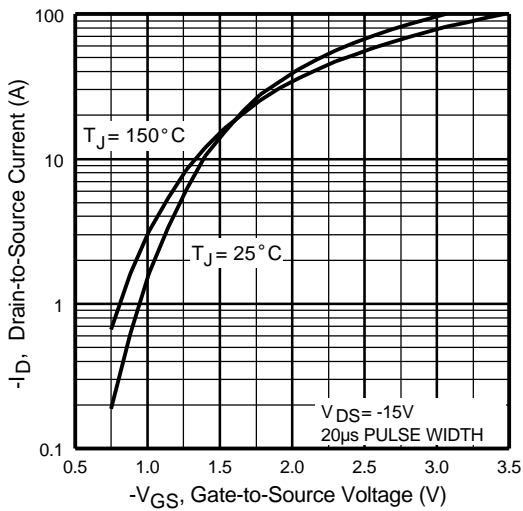

Fig 3. Typical Transfer Characteristics

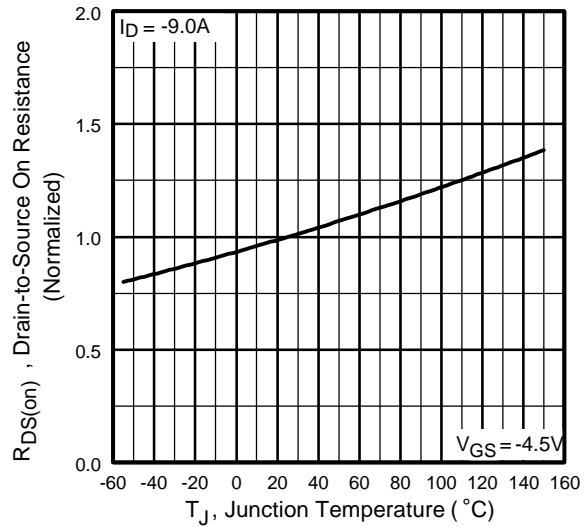

Fig 4. Normalized On-Resistance Vs. Temperature

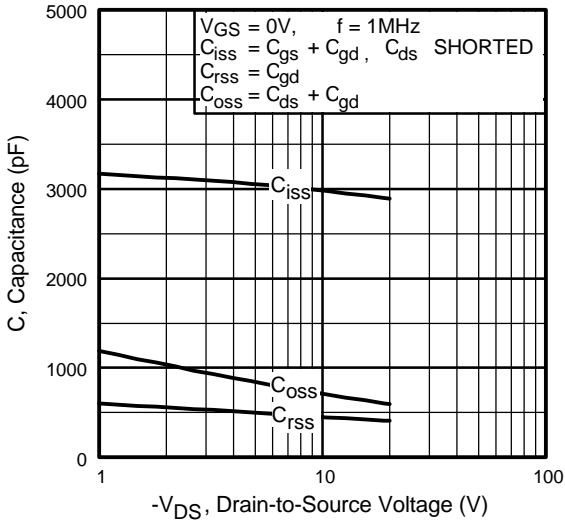

Fig 5. Typical Capacitance Vs. Drain-to-Source Voltage

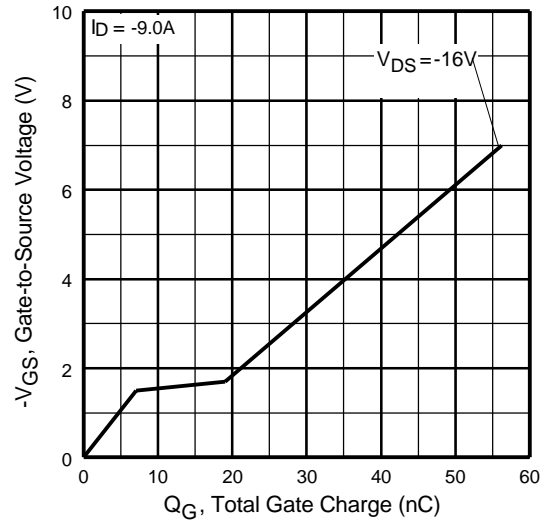

Fig 6. Typical Gate Charge Vs. Gate-to-Source Voltage

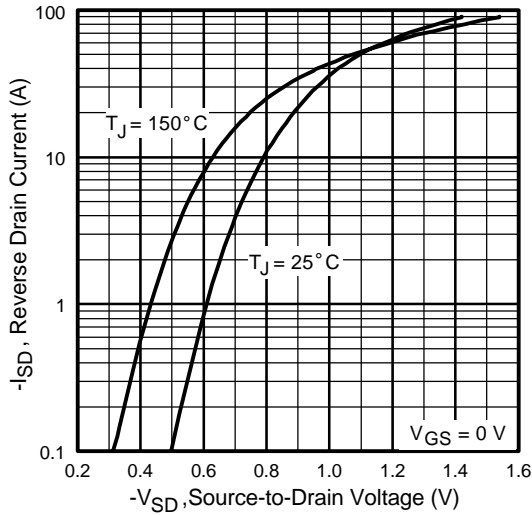

Fig 7. Typical Source-Drain Diode Forward Voltage

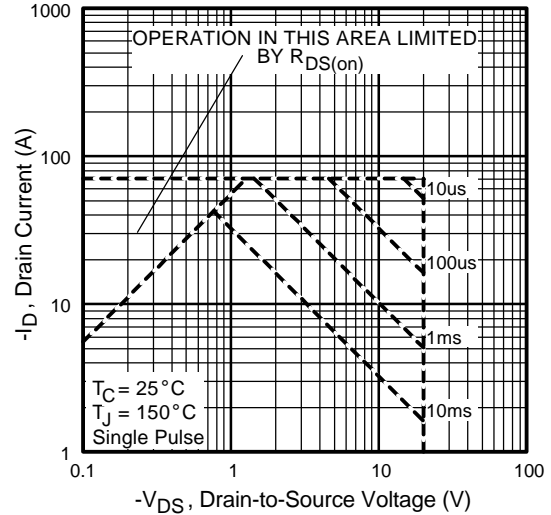

Fig 8. Maximum Safe Operating Area

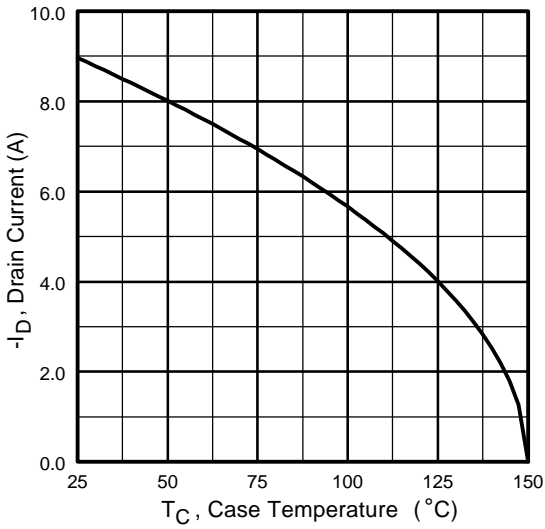

Fig 9. Maximum Drain Current Vs. Case Temperature

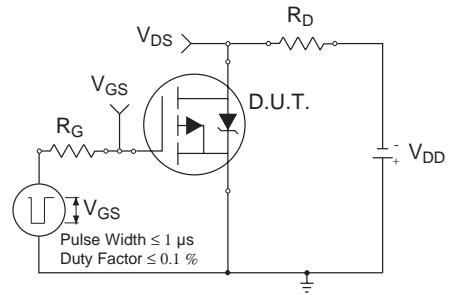

Fig 10a. Switching Time Test Circuit

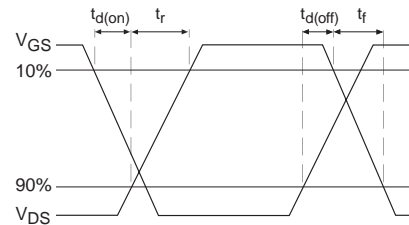

Fig 10b. Switching Time Waveforms

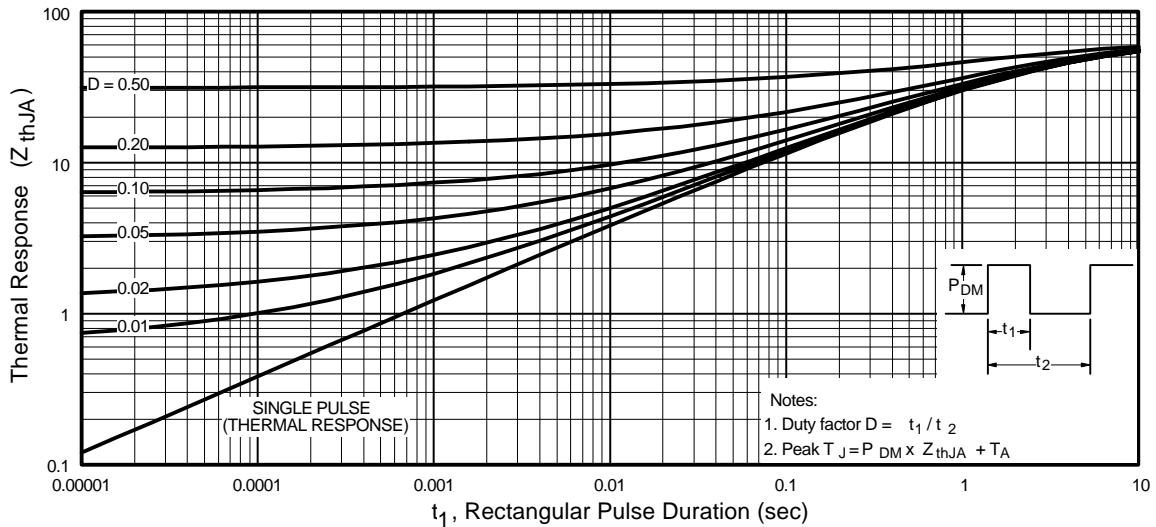

Fig 11. Maximum Effective Transient Thermal Impedance, Junction-to-Ambient

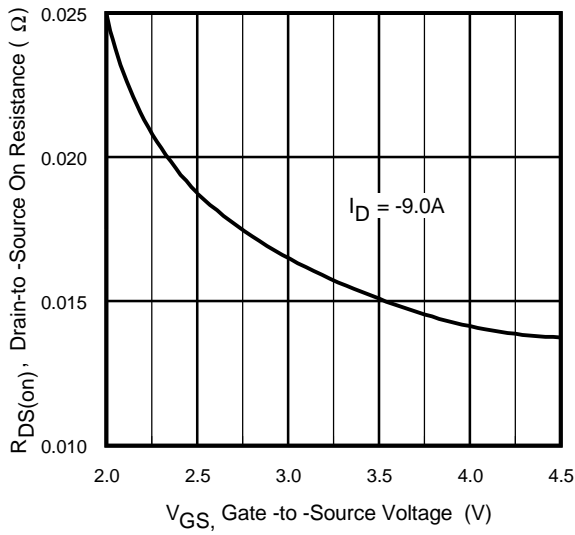

Fig 12. Typical On-Resistance Vs. Gate Voltage

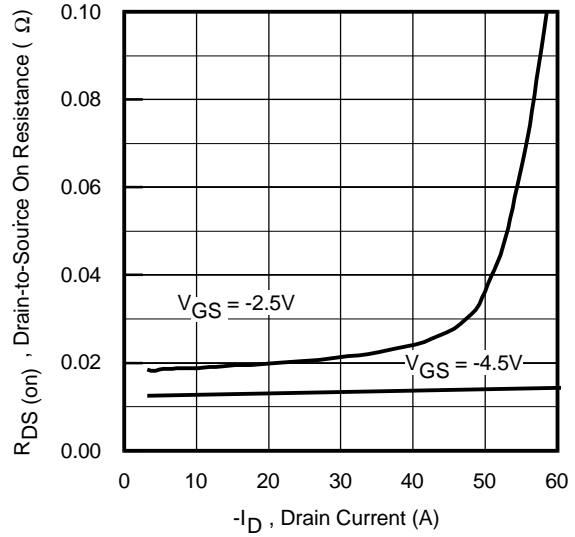

Fig 13. Typical On-Resistance Vs. Drain Current

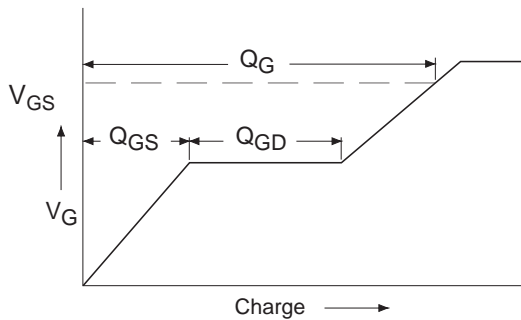

Fig 14a. Basic Gate Charge Waveform

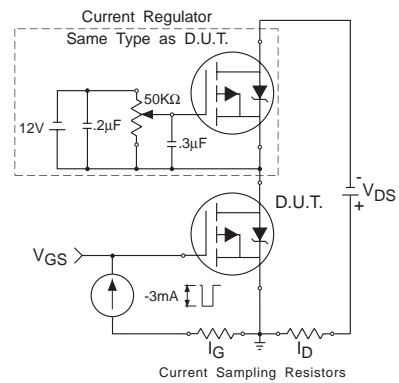
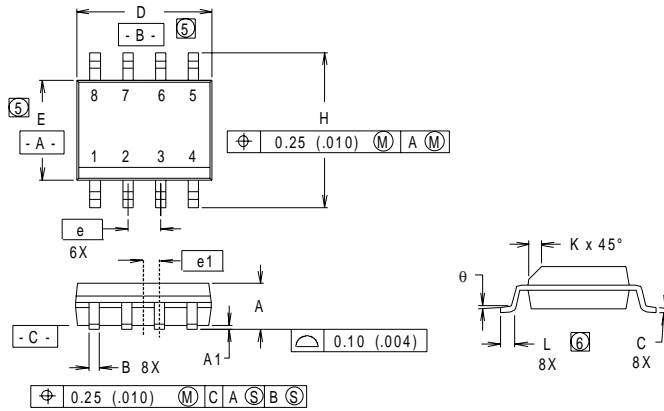

Fig 14b. Gate Charge Test Circuit

SO-8 Package Details



DIM	INCHES		MILLIMETERS	
	MIN	MAX	MIN	MAX
A	.0532	.0688	1.35	1.75
A1	.0040	.0098	0.10	0.25
B	.014	.018	0.36	0.46
C	.0075	.0098	0.19	0.25
D	.189	.196	4.80	4.98
E	.150	.157	3.81	3.99
e	.050 BASIC		1.27 BASIC	
e1	.025 BASIC		0.635 BASIC	
H	.2284	.2440	5.80	6.20
K	.011	.019	0.28	0.48
L	0.16	.050	0.41	1.27
θ	0°	8°	0°	8°

RECOMMENDED FOOTPRINT

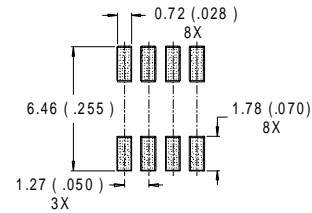

- NOTES:
1. DIMENSIONING AND TOLERANCING PER ANS Y14.5M-1982.
 2. CONTROLLING DIMENSION : INCH.
 3. DIMENSIONS ARE SHOWN IN MILLIMETERS (INCHES).
 4. OUTLINE CONFORMS TO JEDEC OUTLINE MS-012AA.
 5. DIMENSION DOES NOT INCLUDE MOLD PROTRUSIONS
MOLD PROTRUSIONS NOT TO EXCEED 0.25 (.006).
 6. DIMENSIONS IS THE LENGTH OF LEAD FOR SOLDERING TO A SUBSTRATE..

Part Marking

EXAMPLE: THIS IS AN IRF7101

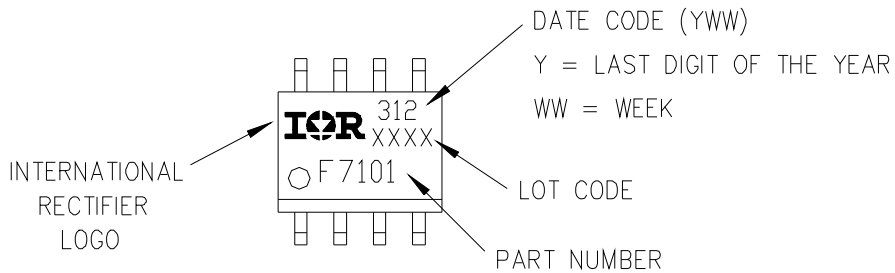

IRF7324

International
IR Rectifier

Tape and Reel

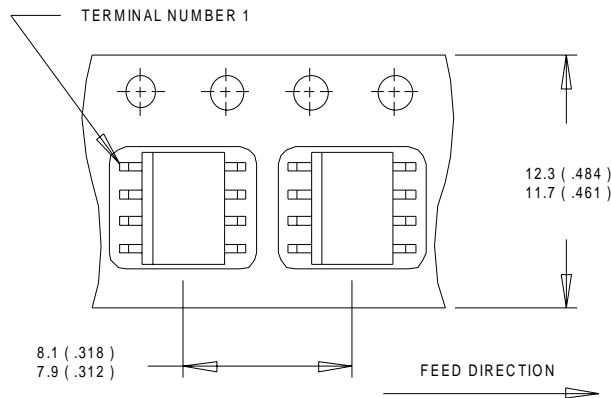

- NOTES:
1. CONTROLLING DIMENSION : MILLIMETER.
 2. ALL DIMENSIONS ARE SHOWN IN MILLIMETERS(INCHES).
 3. OUTLINE CONFORMS TO EIA-481 & EIA-541.

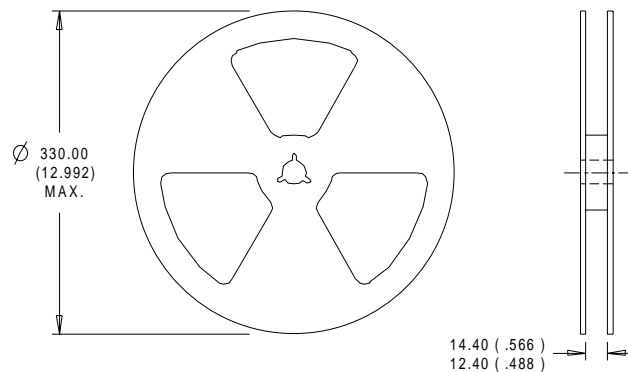

- NOTES :
1. CONTROLLING DIMENSION : MILLIMETER.
 2. OUTLINE CONFORMS TO EIA-481 & EIA-541.

International
IR Rectifier

WORLD HEADQUARTERS: 233 Kansas St., El Segundo, California 90245, Tel: (310) 252-7105

IR GREAT BRITAIN: Hurst Green, Oxted, Surrey RH8 9BB, UK Tel: ++ 44 1883 732020

IR CANADA: 15 Lincoln Court, Brampton, Ontario L6T3Z2, Tel: (905) 453 2200

IR GERMANY: Saalburgstrasse 157, 61350 Bad Homburg Tel: ++ 49 6172 96590

IR ITALY: Via Liguria 49, 10071 Borgaro, Torino Tel: ++ 39 11 451 0111

IR JAPAN: K&H Bldg., 2F, 30-4 Nishi-Ikebukuro 3-Chome, Toshima-Ku, Tokyo Japan 171 Tel: 81 3 3983 0086

IR SOUTHEAST ASIA: 1 Kim Seng Promenade, Great World City West Tower, 13-11, Singapore 237994 Tel: ++ 65 838 4630

IR TAIWAN: 16 Fl. Suite D. 207, Sec. 2, Tun Haw South Road, Taipei, 10673, Taiwan Tel: 886-2-2377-9936

Data and specifications subject to change without notice. 2/00