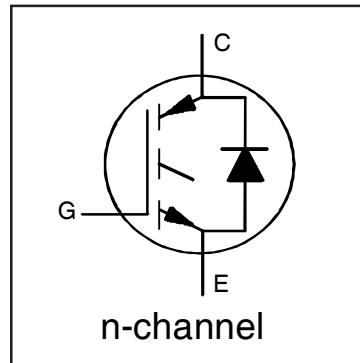


**INSULATED GATE BIPOLAR TRANSISTOR WITH  
ULTRAFAST SOFT RECOVERY DIODE**

**IRGP4066DPbF  
IRGP4066D-EPbF**

**Features**

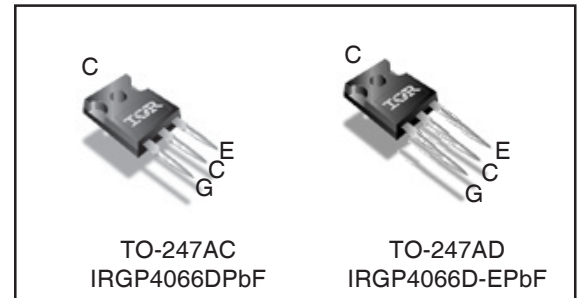
- Low  $V_{CE(ON)}$  Trench IGBT Technology
- Low Switching Losses
- Maximum Junction Temperature 175 °C
- 5  $\mu$ S short circuit SOA
- Square RBSOA
- 100% of The Parts Tested for  $I_{LM}$
- Positive  $V_{CE(ON)}$  Temperature Coefficient
- Tight Parameter Distribution
- Lead Free Package



$V_{CES} = 600V$
$I_{C(Nominal)} = 75A$
$t_{SC} \geq 5\mu s, T_{J(max)} = 175^{\circ}C$
$V_{CE(on)} \text{ typ.} = 1.70V$

**Benefits**

- High Efficiency in a Wide Range of Applications
- Suitable for a Wide Range of Switching Frequencies due to Low  $V_{CE(ON)}$  and Low Switching Losses
- Rugged Transient Performance for Increased Reliability
- Excellent Current Sharing in Parallel Operation



<b>G</b>	<b>C</b>	<b>E</b>
Gate	Collector	Emitter

**Absolute Maximum Ratings**

	Parameter	Max.	Units
$V_{CES}$	Collector-to-Emitter Voltage	600	V
$I_C @ T_C = 25^{\circ}C$	Continuous Collector Current	140	A
$I_C @ T_C = 100^{\circ}C$	Continuous Collector Current	90	
$I_{NOMINAL}$	Nominal Current	75	
$I_{CM}$	Pulse Collector Current, $V_{GE} = 15V$	225	
$I_{LM}$	Clamped Inductive Load Current, $V_{GE} = 20V$ ①	300	
$I_F @ T_C = 25^{\circ}C$	Diode Continuous Forward Current	140	
$I_F @ T_C = 100^{\circ}C$	Diode Continuous Forward Current	90	
$I_{FM}$	Diode Maximum Forward Current ②	300	
$V_{GE}$	Continuous Gate-to-Emitter Voltage	$\pm 20$	V
	Transient Gate-to-Emitter Voltage	$\pm 30$	
$P_D @ T_C = 25^{\circ}C$	Maximum Power Dissipation	454	W
	$P_D @ T_C = 100^{\circ}C$	Maximum Power Dissipation	
$T_J$ $T_{STG}$	Operating Junction and Storage Temperature Range	-55 to +175	$^{\circ}C$
	Soldering Temperature, for 10 sec.	300 (0.063 in. (1.6mm) from case)	
	Mounting Torque, 6-32 or M3 Screw	10 lbf-in (1.1 N-m)	

**Thermal Resistance**

	Parameter	Min.	Typ.	Max.	Units
$R_{\theta JC}$ (IGBT)	Thermal Resistance Junction-to-Case-(each IGBT) ④	—	—	0.33	$^{\circ}C/W$
$R_{\theta JC}$ (Diode)	Thermal Resistance Junction-to-Case-(each Diode) ④	—	—	1.0	
$R_{\theta CS}$	Thermal Resistance, Case-to-Sink (flat, greased surface)	—	0.24	—	
$R_{\theta JA}$	Thermal Resistance, Junction-to-Ambient (typical socket mount)	—	—	40	

## Electrical Characteristics @ T<sub>J</sub> = 25°C (unless otherwise specified)

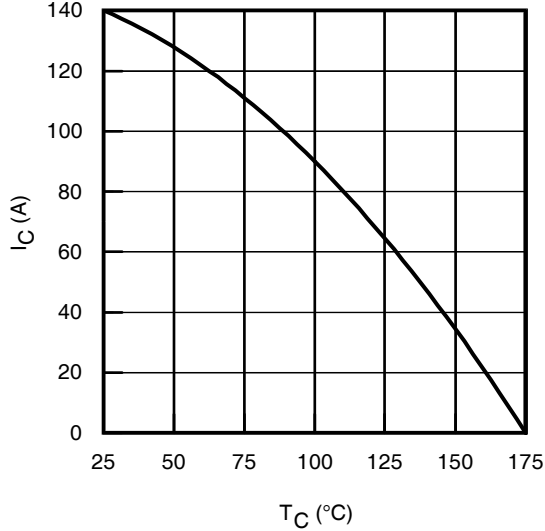
	Parameter	Min.	Typ.	Max.	Units	Conditions
V <sub>(BR)CES</sub>	Collector-to-Emitter Breakdown Voltage	600	—	—	V	V <sub>GE</sub> = 0V, I <sub>C</sub> = 100μA ③
ΔV <sub>(BR)CES</sub> /ΔT <sub>J</sub>	Temperature Coeff. of Breakdown Voltage	—	0.30	—	V/°C	V <sub>GE</sub> = 0V, I <sub>C</sub> = 2.0mA (25°C-175°C)
V <sub>CE(on)</sub>	Collector-to-Emitter Saturation Voltage	—	1.70	2.10	V	I <sub>C</sub> = 75A, V <sub>GE</sub> = 15V, T <sub>J</sub> = 25°C ②
		—	2.0	—		I <sub>C</sub> = 75A, V <sub>GE</sub> = 15V, T <sub>J</sub> = 150°C ②
		—	2.1	—		I <sub>C</sub> = 75A, V <sub>GE</sub> = 15V, T <sub>J</sub> = 175°C ②
V <sub>GE(th)</sub>	Gate Threshold Voltage	4.0	—	6.5	V	V <sub>CE</sub> = V <sub>GE</sub> , I <sub>C</sub> = 2.1mA
ΔV <sub>GE(th)</sub> /ΔT <sub>J</sub>	Threshold Voltage temp. coefficient	—	-21	—	mV/°C	V <sub>CE</sub> = V <sub>GE</sub> , I <sub>C</sub> = 2.1mA (25°C - 175°C)
g <sub>fe</sub>	Forward Transconductance	—	50	—	S	V <sub>CE</sub> = 50V, I <sub>C</sub> = 75A, PW = 60μs
I <sub>CES</sub>	Collector-to-Emitter Leakage Current	—	1.0	100	μA	V <sub>GE</sub> = 0V, V <sub>CE</sub> = 600V
		—	1040	—		V <sub>GE</sub> = 0V, V <sub>CE</sub> = 600V, T <sub>J</sub> = 175°C
V <sub>FM</sub>	Diode Forward Voltage Drop	—	2.23	3.0	V	I <sub>F</sub> = 75A
		—	1.8	—		I <sub>F</sub> = 75A, T <sub>J</sub> = 175°C
I <sub>GES</sub>	Gate-to-Emitter Leakage Current	—	—	±200	nA	V <sub>GE</sub> = ±20V

## Switching Characteristics @ T<sub>J</sub> = 25°C (unless otherwise specified)

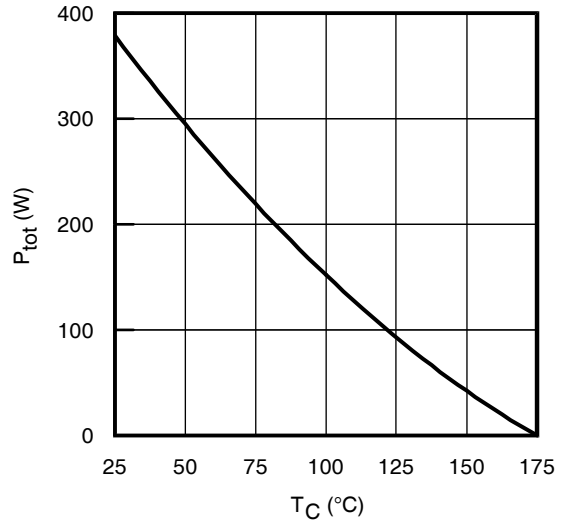
	Parameter	Min.	Typ.	Max.	Units	Conditions
Q <sub>g</sub>	Total Gate Charge (turn-on)	—	150	225	nC	I <sub>C</sub> = 75A V <sub>GE</sub> = 15V V <sub>CC</sub> = 400V
Q <sub>ge</sub>	Gate-to-Emitter Charge (turn-on)	—	40	60		
Q <sub>gc</sub>	Gate-to-Collector Charge (turn-on)	—	60	90		
E <sub>on</sub>	Turn-On Switching Loss	—	2465	3360	μJ	I <sub>C</sub> = 75A, V <sub>CC</sub> = 400V, V <sub>GE</sub> = 15V R <sub>G</sub> = 10Ω, L = 200μH, T <sub>J</sub> = 25°C Energy losses include tail & diode reverse recovery
E <sub>off</sub>	Turn-Off Switching Loss	—	2155	3040		
E <sub>total</sub>	Total Switching Loss	—	4620	6400		
t <sub>d(on)</sub>	Turn-On delay time	—	50	70	ns	I <sub>C</sub> = 75A, V <sub>CC</sub> = 400V, V <sub>GE</sub> = 15V R <sub>G</sub> = 10Ω, L = 200μH, T <sub>J</sub> = 25°C
t <sub>r</sub>	Rise time	—	70	90		
t <sub>d(off)</sub>	Turn-Off delay time	—	200	225		
t <sub>f</sub>	Fall time	—	60	80		
E <sub>on</sub>	Turn-On Switching Loss	—	3870	—	μJ	I <sub>C</sub> = 75A, V <sub>CC</sub> = 400V, V <sub>GE</sub> = 15V R <sub>G</sub> = 10Ω, L = 200μH, T <sub>J</sub> = 175°C Energy losses include tail & diode reverse recovery
E <sub>off</sub>	Turn-Off Switching Loss	—	2815	—		
E <sub>total</sub>	Total Switching Loss	—	6685	—		
t <sub>d(on)</sub>	Turn-On delay time	—	50	—	ns	I <sub>C</sub> = 75A, V <sub>CC</sub> = 400V, V <sub>GE</sub> = 15V R <sub>G</sub> = 10Ω, L = 200μH T <sub>J</sub> = 175°C
t <sub>r</sub>	Rise time	—	70	—		
t <sub>d(off)</sub>	Turn-Off delay time	—	240	—		
t <sub>f</sub>	Fall time	—	70	—		
C <sub>ies</sub>	Input Capacitance	—	4440	—	pF	V <sub>GE</sub> = 0V V <sub>CC</sub> = 30V f = 1.0Mhz
C <sub>oes</sub>	Output Capacitance	—	245	—		
C <sub>res</sub>	Reverse Transfer Capacitance	—	130	—		
RBSOA	Reverse Bias Safe Operating Area	FULL SQUARE				T <sub>J</sub> = 175°C, I <sub>C</sub> = 300A V <sub>CC</sub> = 480V, V <sub>p</sub> ≤ 600V R <sub>G</sub> = 10Ω, V <sub>GE</sub> = +20V to 0V
SCSOA	Short Circuit Safe Operating Area	5	—	—	μs	V <sub>CC</sub> = 400V, V <sub>p</sub> ≤ 600V R <sub>G</sub> = 10Ω, V <sub>GE</sub> = +15V to 0V
E <sub>rec</sub>	Reverse Recovery Energy of the Diode	—	470	—	μJ	T <sub>J</sub> = 175°C
t <sub>rr</sub>	Diode Reverse Recovery Time	—	155	—	ns	V <sub>CC</sub> = 400V, I <sub>F</sub> = 75A
I <sub>rr</sub>	Peak Reverse Recovery Current	—	27	—	A	V <sub>GE</sub> = 15V, R <sub>G</sub> = 10Ω, L = 60μH

### Notes:

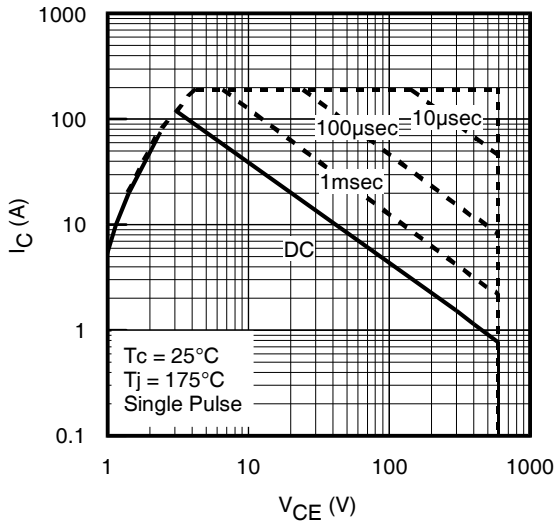
- ① V<sub>CC</sub> = 80% (V<sub>CES</sub>), V<sub>GE</sub> = 20V, L = 10μH, R<sub>G</sub> = 10Ω.
- ② Pulse width limited by max. junction temperature.
- ③ Refer to AN-1086 for guidelines for measuring V<sub>(BR)CES</sub> safely.
- ④ R<sub>G</sub> is measured at T<sub>J</sub> of approximately 90°C.



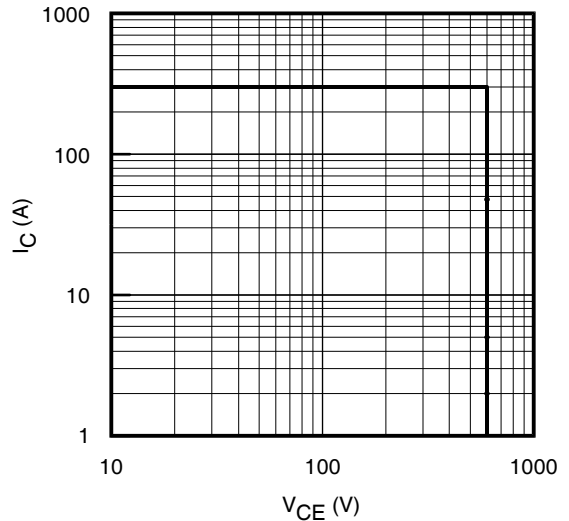
**Fig. 1** - Maximum DC Collector Current vs. Case Temperature



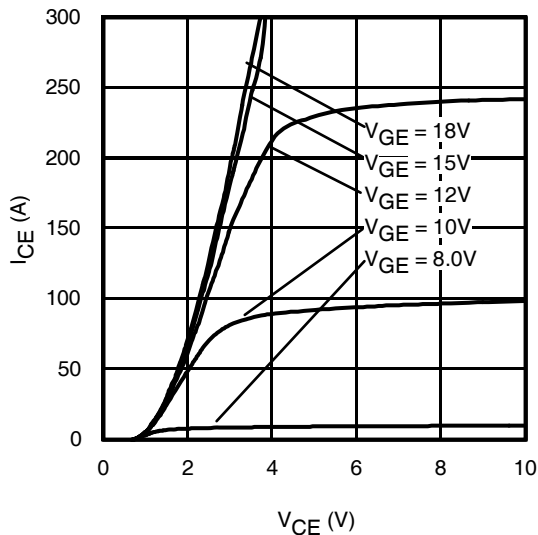
**Fig. 2** - Power Dissipation vs. Case Temperature



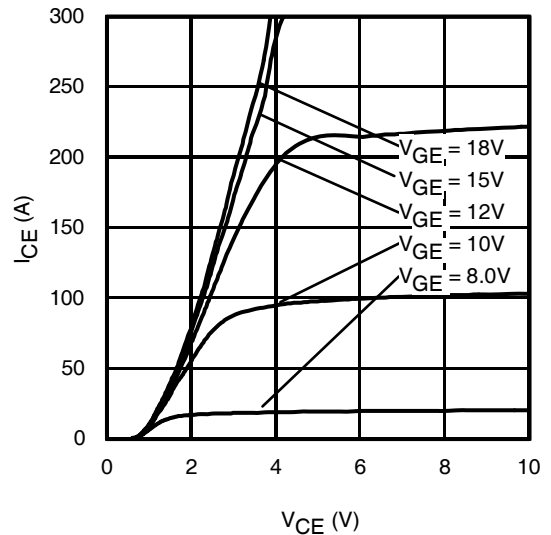
**Fig. 3** - Forward SOA  
 $T_C = 25^\circ\text{C}$ ,  $T_J \leq 175^\circ\text{C}$ ;  $V_{GE} = 15\text{V}$



**Fig. 4** - Reverse Bias SOA  
 $T_J = 175^\circ\text{C}$ ;  $V_{GE} = 20\text{V}$

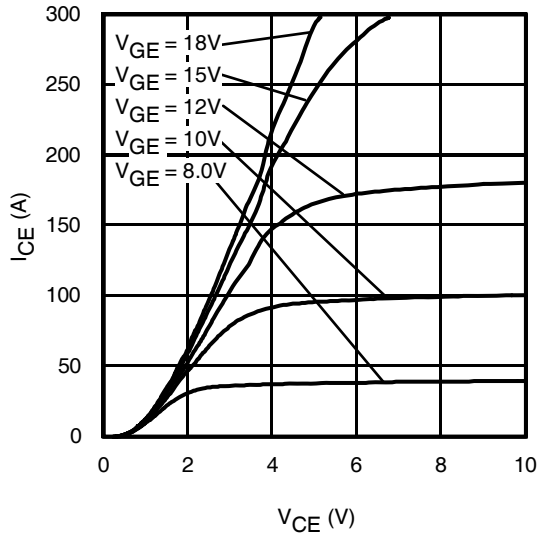


**Fig. 5** - Typ. IGBT Output Characteristics  
 $T_J = -40^\circ\text{C}$ ;  $t_p \leq 60\mu\text{s}$

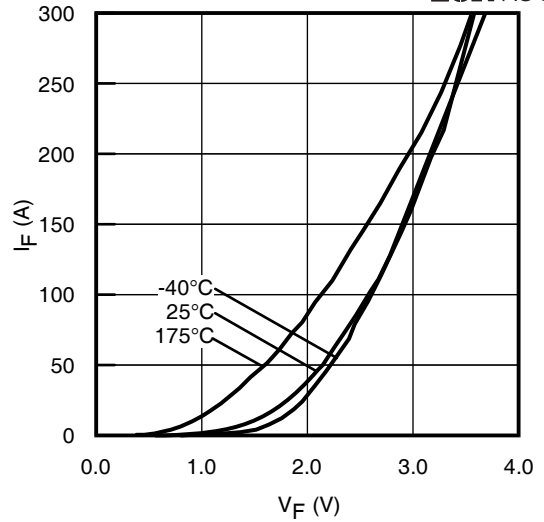


**Fig. 6** - Typ. IGBT Output Characteristics  
 $T_J = 25^\circ\text{C}$ ;  $t_p \leq 60\mu\text{s}$

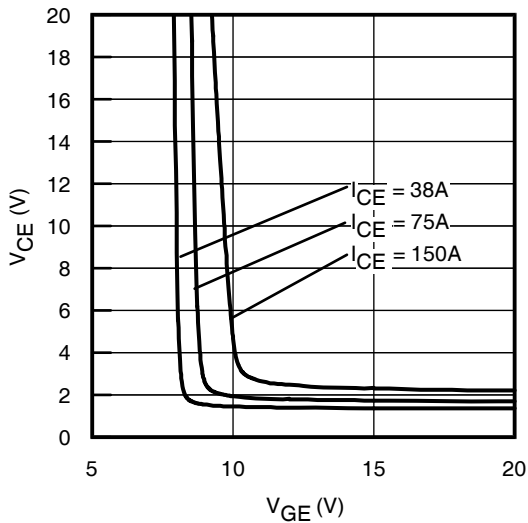
# IRGP4066DPbF/IRGP4066D-EPbF



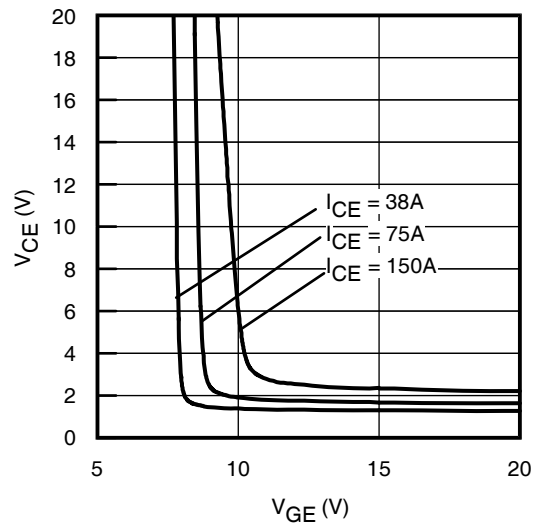
**Fig. 7** - Typ. IGBT Output Characteristics  
 $T_J = 175^\circ\text{C}$ ;  $t_p = \leq 60\mu\text{s}$



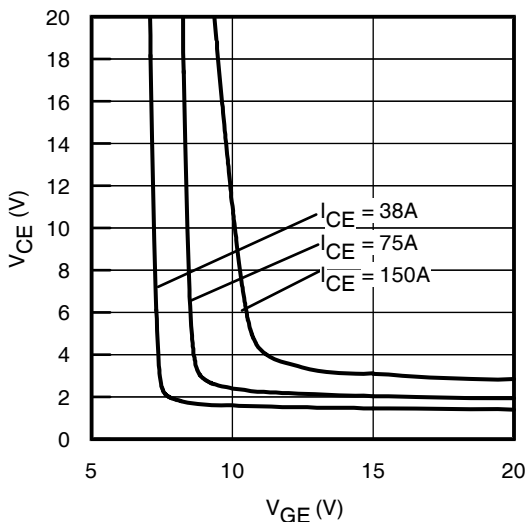
**Fig. 8** - Typ. Diode Forward Characteristics  
 $t_p = 80\mu\text{s}$



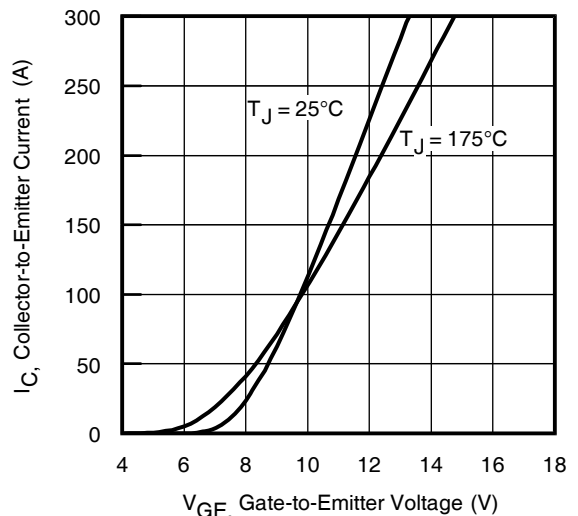
**Fig. 9** - Typical  $V_{CE}$  vs.  $V_{GE}$   
 $T_J = -40^\circ\text{C}$



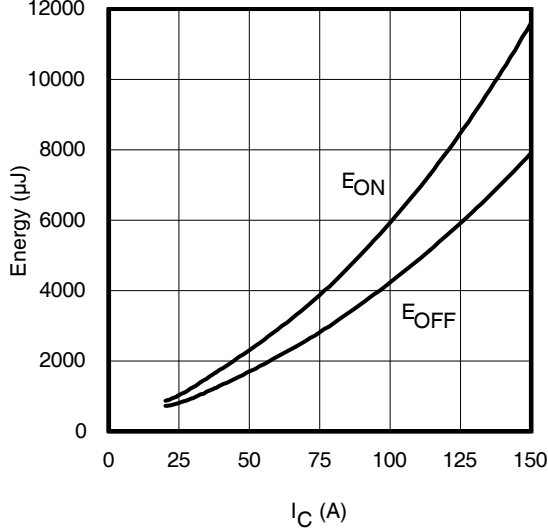
**Fig. 10** - Typical  $V_{CE}$  vs.  $V_{GE}$   
 $T_J = 25^\circ\text{C}$



**Fig. 11** - Typical  $V_{CE}$  vs.  $V_{GE}$   
 $T_J = 175^\circ\text{C}$

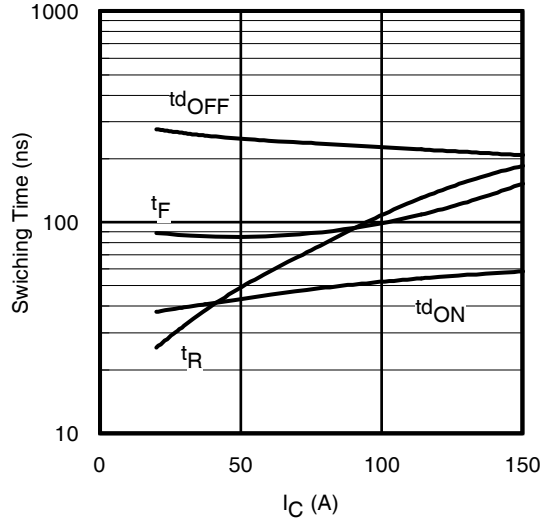


**Fig. 12** - Typ. Transfer Characteristics  
 $V_{CE} = 50\text{V}$ ;  $t_p = 60\mu\text{s}$



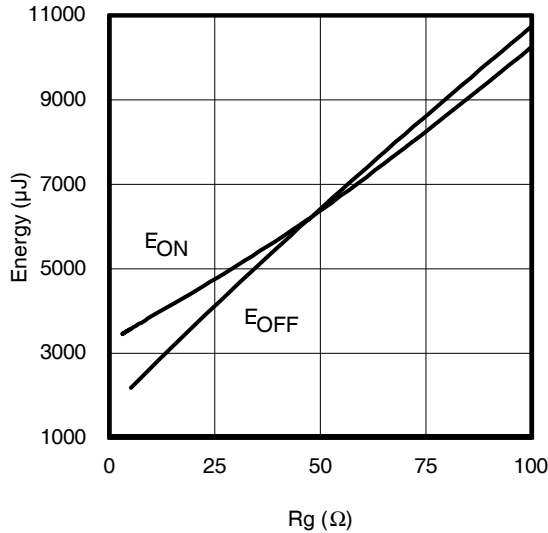
**Fig. 13** - Typ. Energy Loss vs.  $I_C$

$T_J = 175^\circ\text{C}$ ;  $L = 200\mu\text{H}$ ;  $V_{CE} = 400\text{V}$ ,  $R_G = 10\Omega$ ;  $V_{GE} = 15\text{V}$



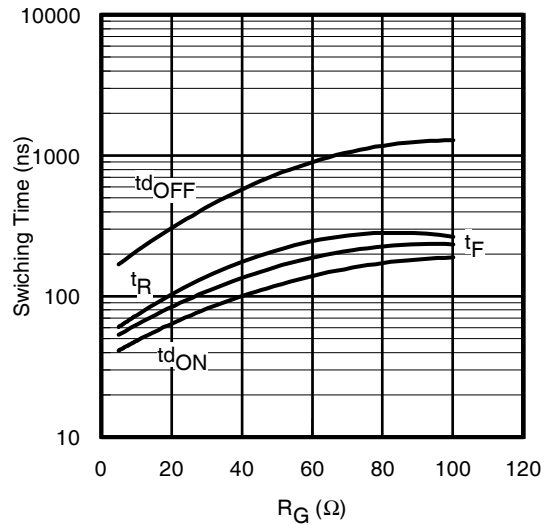
**Fig. 14** - Typ. Switching Time vs.  $I_C$

$T_J = 175^\circ\text{C}$ ;  $L = 200\mu\text{H}$ ;  $V_{CE} = 400\text{V}$ ,  $R_G = 10\Omega$ ;  $V_{GE} = 15\text{V}$



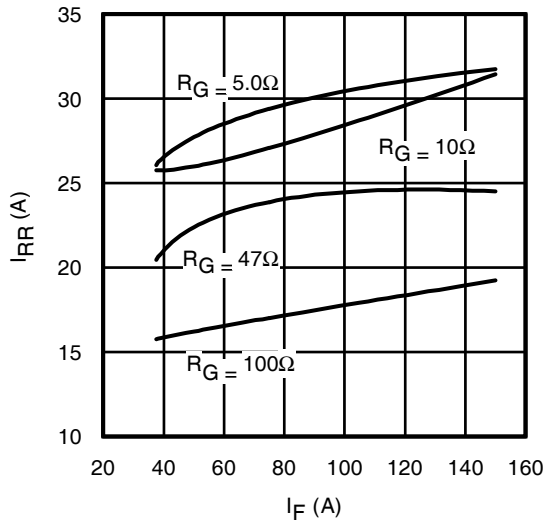
**Fig. 15** - Typ. Energy Loss vs.  $R_G$

$T_J = 175^\circ\text{C}$ ;  $L = 200\mu\text{H}$ ;  $V_{CE} = 400\text{V}$ ,  $I_{CE} = 75\text{A}$ ;  $V_{GE} = 15\text{V}$



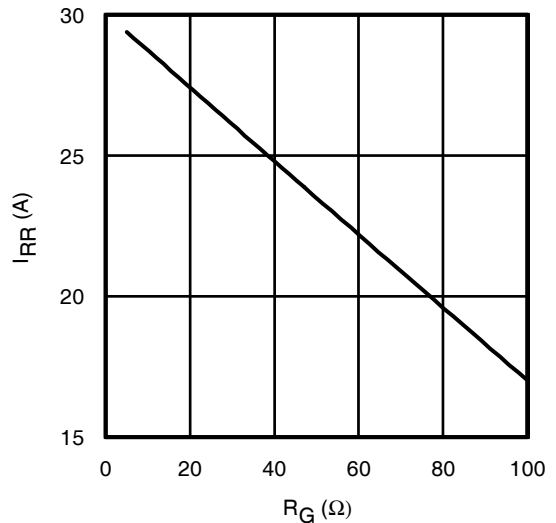
**Fig. 16** - Typ. Switching Time vs.  $R_G$

$T_J = 175^\circ\text{C}$ ;  $L = 200\mu\text{H}$ ;  $V_{CE} = 400\text{V}$ ,  $I_{CE} = 75\text{A}$ ;  $V_{GE} = 15\text{V}$



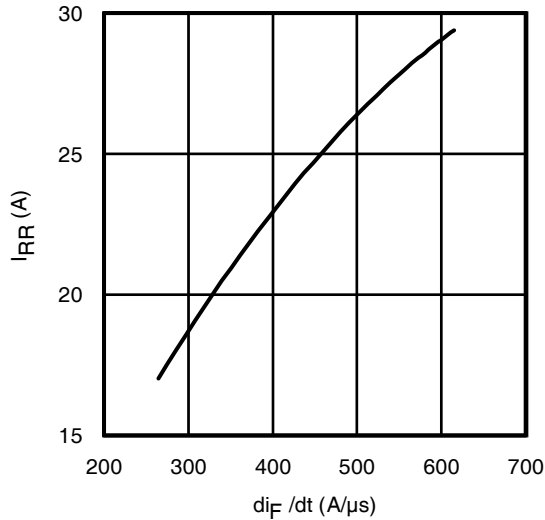
**Fig. 17** - Typ. Diode  $I_{RR}$  vs.  $I_F$

$T_J = 175^\circ\text{C}$

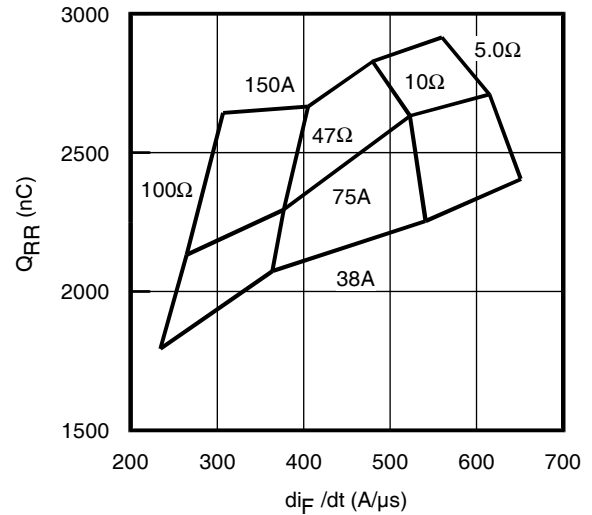


**Fig. 18** - Typ. Diode  $I_{RR}$  vs.  $R_G$

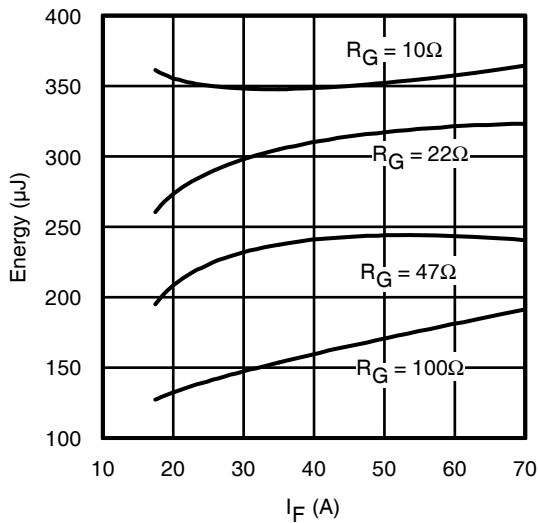
$T_J = 175^\circ\text{C}$



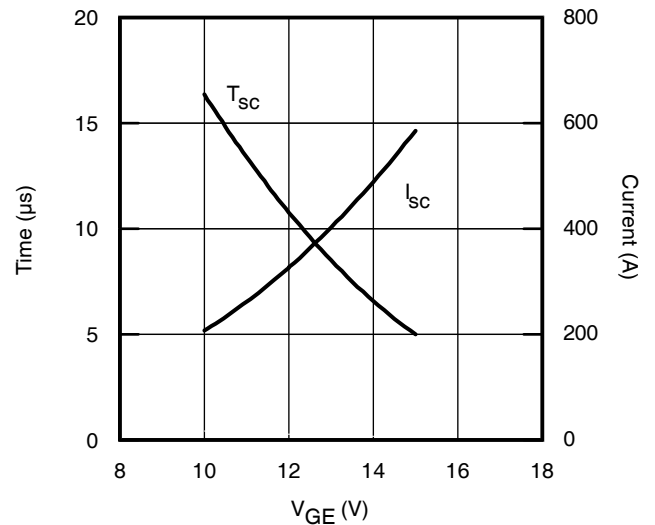
**Fig. 19** - Typ. Diode  $I_{RR}$  vs.  $di_F/dt$   
 $V_{CC} = 400V$ ;  $V_{GE} = 15V$ ;  $I_F = 75A$ ;  $T_J = 175^\circ C$



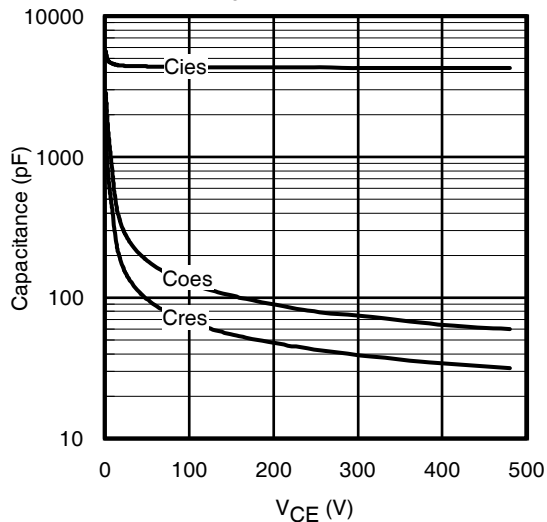
**Fig. 20** - Typ. Diode  $Q_{RR}$  vs.  $di_F/dt$   
 $V_{CC} = 400V$ ;  $V_{GE} = 15V$ ;  $T_J = 175^\circ C$



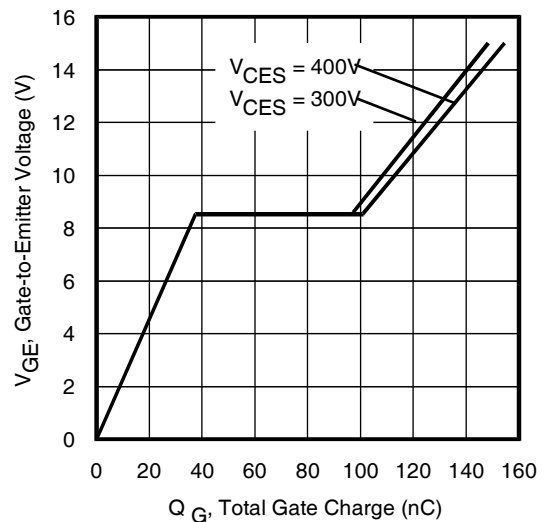
**Fig. 21** - Typ. Diode  $E_{RR}$  vs.  $I_F$   
 $T_J = 175^\circ C$



**Fig. 22** -  $V_{GE}$  vs. Short Circuit Time  
 $V_{CC} = 400V$ ;  $T_C = 25^\circ C$



**Fig. 23** - Typ. Capacitance vs.  $V_{CE}$   
 $V_{GE} = 0V$ ;  $f = 1MHz$



**Fig. 24** - Typical Gate Charge vs.  $V_{GE}$   
 $I_{CE} = 75A$ ;  $L = 485\mu H$

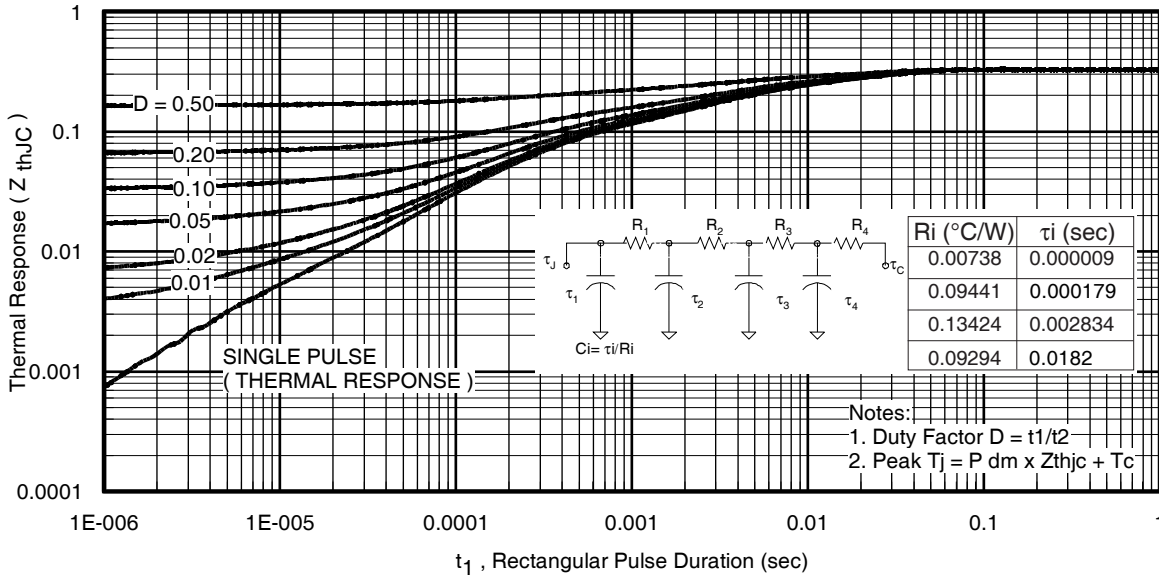


Fig 25. Maximum Transient Thermal Impedance, Junction-to-Case (IGBT)

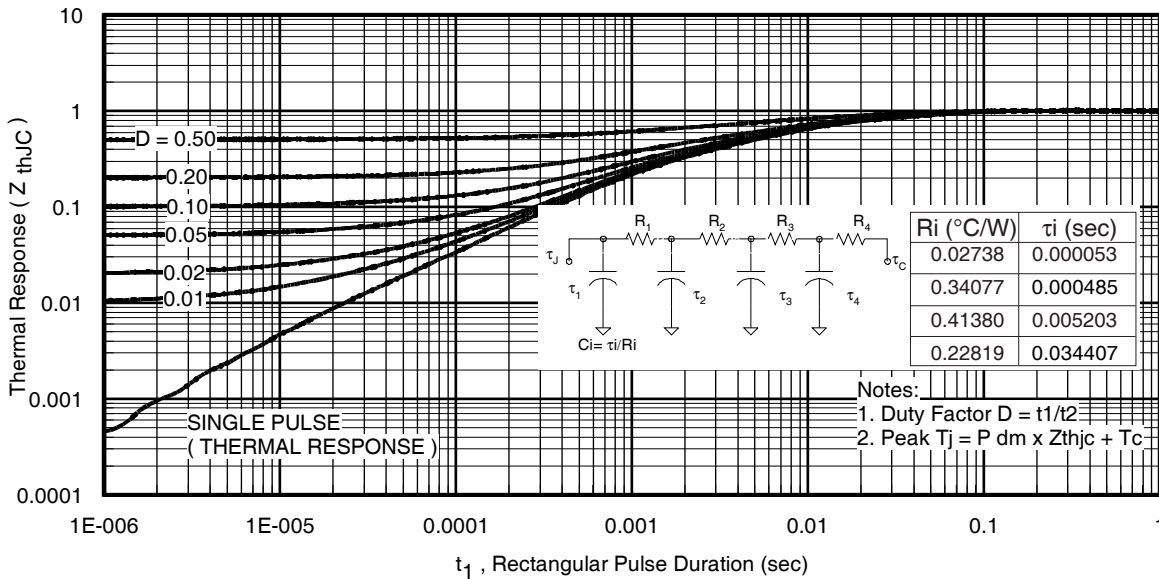
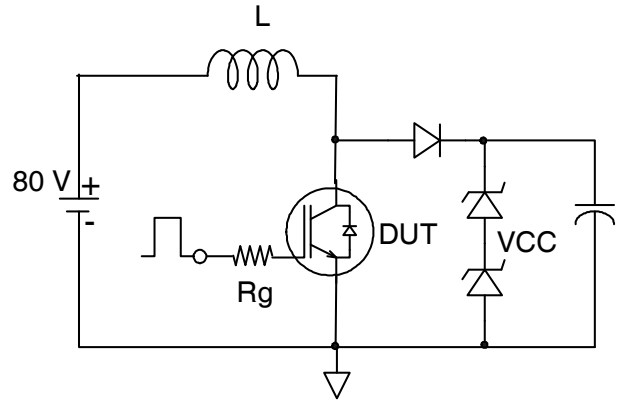


Fig. 26. Maximum Transient Thermal Impedance, Junction-to-Case (DIODE)



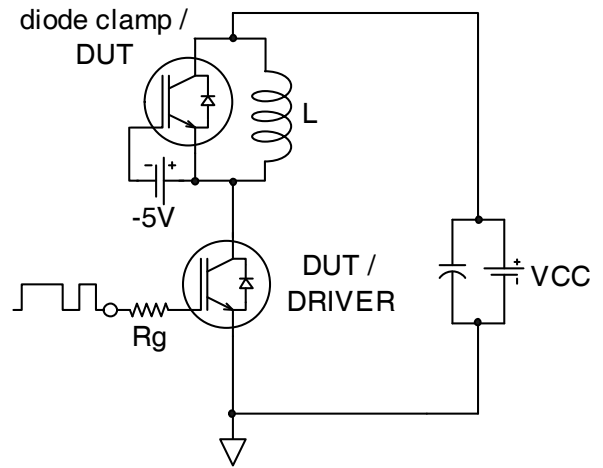
**Fig.C.T.1** - Gate Charge Circuit (turn-off)



**Fig.C.T.2** - RBSOA Circuit



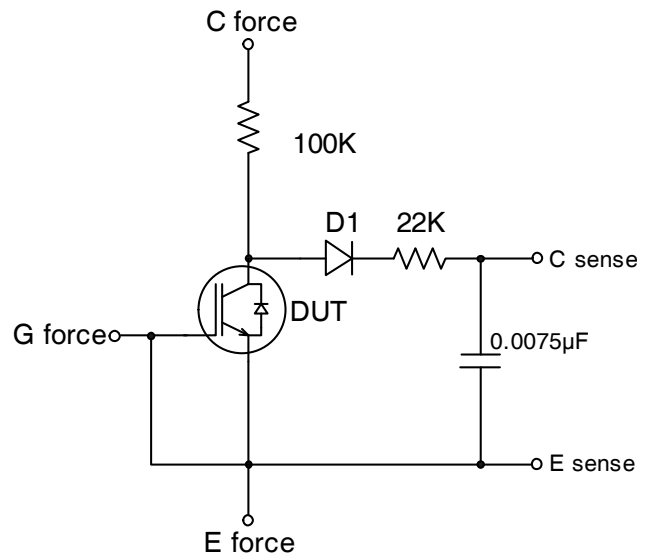
**Fig.C.T.3** - S.C. SOA Circuit



**Fig.C.T.4** - Switching Loss Circuit

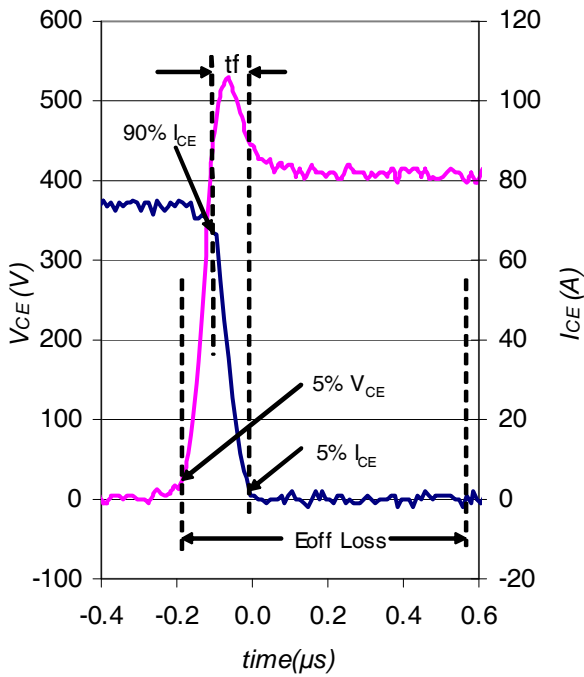


**Fig.C.T.5** - Resistive Load Circuit

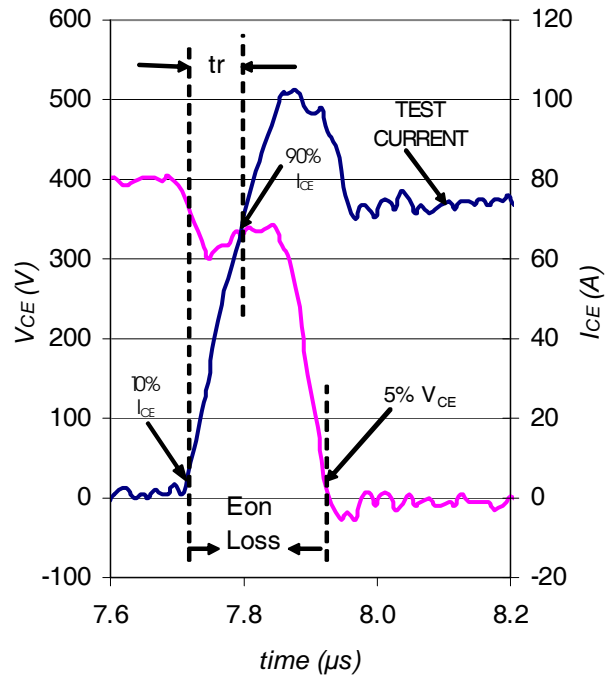


**Fig.C.T.6** - BVCES Filter Circuit

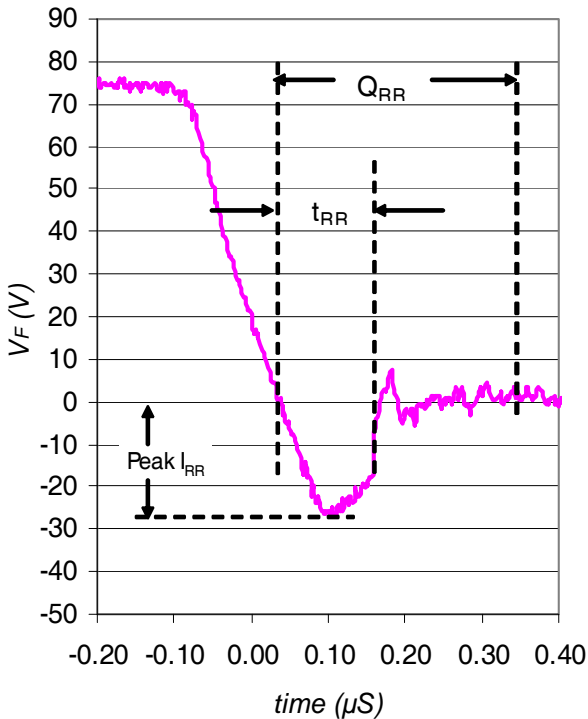




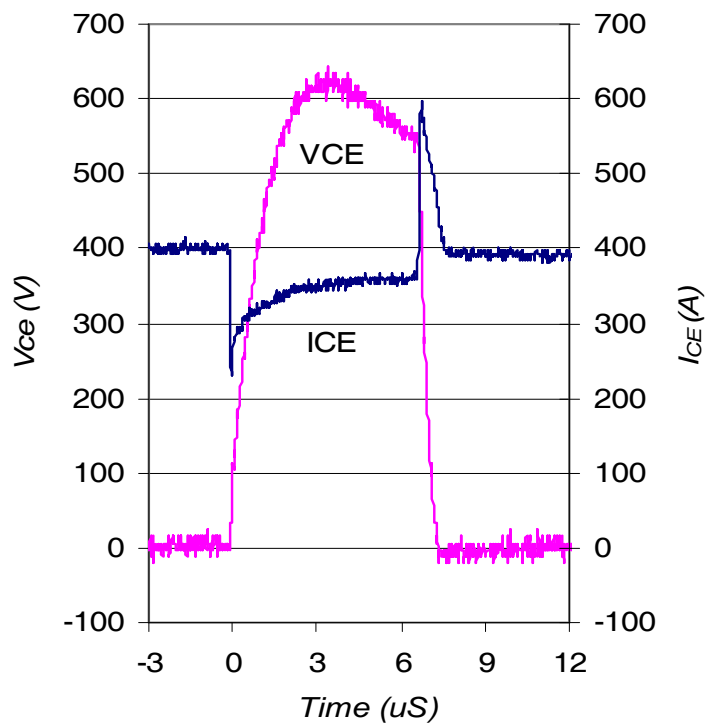
**Fig. WF1** - Typ. Turn-off Loss Waveform  
@  $T_J = 175^\circ\text{C}$  using Fig. CT.4



**Fig. WF2** - Typ. Turn-on Loss Waveform  
@  $T_J = 175^\circ\text{C}$  using Fig. CT.4



**Fig. WF3** - Typ. Diode Recovery Waveform  
@  $T_J = 175^\circ\text{C}$  using Fig. CT.4



**Fig. WF4** - Typ. S.C. Waveform  
@  $T_J = 25^\circ\text{C}$  using Fig. CT.3

# IRGP4066DPbF/IRGP4066D-EPbF

## TO-247AC Package Outline

Dimensions are shown in millimeters (inches)



**NOTES:**

1. DIMENSIONING AND TOLERANCING AS PER ASME Y14.5M 1994.
2. DIMENSIONS ARE SHOWN IN INCHES.
3. CONTOUR OF SLOT OPTIONAL.
4. DIMENSION D & E DO NOT INCLUDE MOLD FLASH. MOLD FLASH SHALL NOT EXCEED .005" (0.127) PER SIDE. THESE DIMENSIONS ARE MEASURED AT THE OUTERMOST EXTREMES OF THE PLASTIC BODY.
5. THERMAL PAD CONTOUR OPTIONAL WITHIN DIMENSIONS D1 & E1.
6. LEAD FINISH UNCONTROLLED IN L1.
7.  $\phi P$  TO HAVE A MAXIMUM DRAFT ANGLE OF 1.5 ° TO THE TOP OF THE PART WITH A MAXIMUM HOLE DIAMETER OF .154 INCH.
8. OUTLINE CONFORMS TO JEDEC OUTLINE TO-247AC .

SYMBOL	DIMENSIONS				NOTES
	INCHES		MILLIMETERS		
	MIN.	MAX.	MIN.	MAX.	
A	.183	.209	4.65	5.31	
A1	.087	.102	2.21	2.59	
A2	.059	.098	1.50	2.49	
b	.039	.055	0.99	1.40	
b1	.039	.053	0.99	1.35	
b2	.065	.094	1.65	2.39	
b3	.065	.092	1.65	2.34	
b4	.102	.135	2.59	3.43	
b5	.102	.133	2.59	3.38	
c	.015	.035	0.38	0.89	
c1	.015	.033	0.38	0.84	
D	.776	.815	19.71	20.70	4
D1	.515	-	13.08	-	5
D2	.020	.053	0.51	1.35	
E	.602	.625	15.29	15.87	4
E1	.530	-	13.46	-	
E2	.178	.216	4.52	5.49	
e	.215 BSC		5.46 BSC		
$\phi k$	.010		0.25		
L	.559	.634	14.20	16.10	
L1	.146	.169	3.71	4.29	
$\phi P$	.140	.144	3.56	3.66	
$\phi P1$	-	.291	-	7.39	
Q	.209	.224	5.31	5.69	
S	.217 BSC		5.51 BSC		

**LEAD ASSIGNMENTS**

**HEXFET**

- 1.- GATE
- 2.- DRAIN
- 3.- SOURCE
- 4.- DRAIN

**IGBTs, CoPACK**

- 1.- GATE
- 2.- COLLECTOR
- 3.- EMITTER
- 4.- COLLECTOR

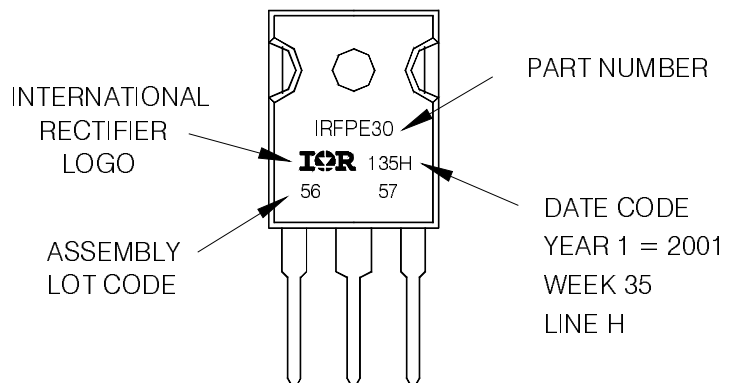
**DIODES**

- 1.- ANODE/OPEN
- 2.- CATHODE
- 3.- ANODE

## TO-247AC Part Marking Information

EXAMPLE: THIS IS AN IRFPE30  
WITH ASSEMBLY  
LOT CODE 5657  
ASSEMBLED ON WW 35, 2001  
IN THE ASSEMBLY LINE "H"

Note: "P" in assembly line position  
indicates "Lead-Free"



TO-247AC package is not recommended for Surface Mount Application.

Note: For the most current drawing please refer to IR website at <http://www.irf.com/package/>

## TO-247AD Package Outline

Dimensions are shown in millimeters (inches)



**NOTES:**

1. DIMENSIONING AND TOLERANCING AS PER ASME Y14.5M 1994.
2. DIMENSIONS ARE SHOWN IN INCHES.
3. CONTOUR OF SLOT OPTIONAL.
4. DIMENSION D & E DO NOT INCLUDE MOLD FLASH. MOLD FLASH SHALL NOT EXCEED .005" (0.127) PER SIDE. THESE DIMENSIONS ARE MEASURED AT THE OUTERMOST EXTREMES OF THE PLASTIC BODY.
5. THERMAL PAD CONTOUR OPTIONAL WITHIN DIMENSIONS D1 & E1.
6. LEAD FINISH UNCONTROLLED IN L1.
7.  $\phi P$  TO HAVE A MAXIMUM DRAFT ANGLE OF 1.5 ° TO THE TOP OF THE PART WITH A MAXIMUM HOLE DIAMETER OF .154 INCH.
8. OUTLINE CONFORMS TO JEDEC OUTLINE TO-247AD.

SYMBOL	DIMENSIONS				NOTES
	INCHES		MILLIMETERS		
	MIN.	MAX.	MIN.	MAX.	
A	.183	.209	4.65	5.31	
A1	.087	.102	2.21	2.59	
A2	.059	.098	1.50	2.49	
b	.039	.055	0.99	1.40	
b1	.039	.053	0.99	1.35	
b2	.065	.094	1.65	2.39	
b3	.065	.092	1.65	2.34	
b4	.102	.135	2.59	3.43	
b5	.102	.133	2.59	3.38	
c	.015	.035	0.38	0.89	
c1	.015	.033	0.38	0.84	
D	.776	.815	19.71	20.70	4
D1	.515	-	13.08	-	5
D2	.020	.053	0.51	1.35	
E	.602	.625	15.29	15.87	4
E1	.530	-	13.46	-	
E2	.178	.216	4.52	5.49	
e	.215 BSC		5.46 BSC		
$\phi k$	.010		0.25		
L	.780	.827	19.57	21.00	
L1	.146	.169	3.71	4.29	
$\phi P$	.140	.144	3.56	3.66	
$\phi P1$	-	.291	-	7.39	
Q	.209	.224	5.31	5.69	
S	.217 BSC		5.51 BSC		

**LEAD ASSIGNMENTS**

- HEXFET**
- 1.- GATE
  - 2.- DRAIN
  - 3.- SOURCE
  - 4.- DRAIN

**IGBTs, CoPACK**

- 1.- GATE
- 2.- COLLECTOR
- 3.- EMITTER
- 4.- COLLECTOR

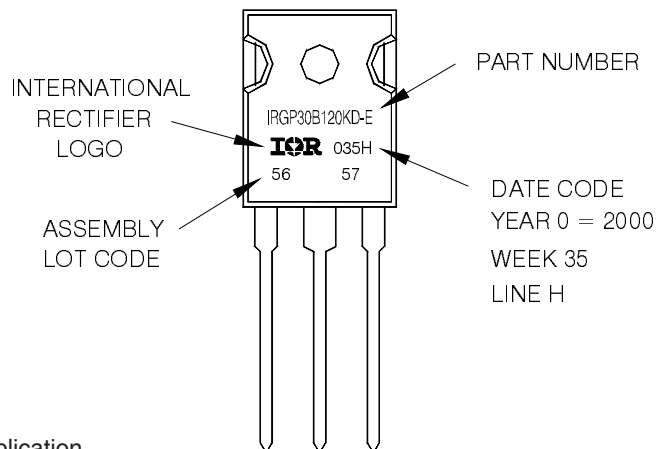
**DIGIDES**

- 1.- ANODE/OPEN
- 2.- CATHODE
- 3.- ANODE

## TO-247AD Part Marking Information

EXAMPLE: THIS IS AN IRGP30B120KD-E  
WITH ASSEMBLY  
LOT CODE 5657  
ASSEMBLED ON WW 35, 2000  
IN THE ASSEMBLY LINE "H"

Note: "P" in assembly line position  
indicates "Lead-Free"



TO-247AD package is not recommended for Surface Mount Application.

Note: For the most current drawing please refer to IR website at <http://www.irf.com/package/>

Data and specifications subject to change without notice.  
This product has been designed and qualified for Industrial market.  
Qualification Standards can be found on IR's Web site.