

TSM900N06

60V N-Channel Power MOSFET

**TO-251S
(IPAK SL)**

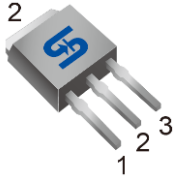

**TO-252
(DPAK)**

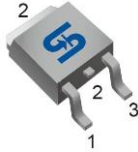

Pin Definition:

1. Gate
2. Drain
3. Source

Key Parameter Performance

Parameter	Value	Unit
V_{DS}	60	V
$R_{DS(on)}$ (max)	$V_{GS} = 10V$	90
	$V_{GS} = 4.5V$	100
Q_g	9.3	nC

SOT-223



Ordering Information

Part No.	Package	Packing
TSM900N06CH X0G	TO-251S	75pcs / Tube
TSM900N06CP ROG	TO-252	2.5kpcs / 13" Reel
TSM900N06CW RPG	SOT-223	2.5kpcs / 13" Reel

Note: "G" denotes for Halogen- and Antimony-free as those which contain <900ppm bromine, <900ppm chlorine (<1500ppm total Br + Cl) and <1000ppm antimony compounds

Block Diagram

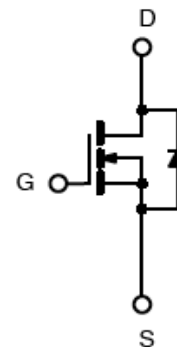

N-Channel MOSFET

Absolute Maximum Ratings ($T_c = 25^\circ C$ unless otherwise noted)

Parameter	Symbol	Limit			Unit
		IPAK	DPAK	SOT-223	
Drain-Source Voltage	V_{DS}	60			V
Gate-Source Voltage	V_{GS}	± 20			V
Continuous Drain Current ^(Note 1)	I_D	$T_c = 25^\circ C$			A
		$T_c = 100^\circ C$			A
Pulsed Drain Current ^(Note 1)	I_{DM}	44			A
Single Pulse Avalanche Energy ^(Note 3)	E_{AS}	25			mJ
Single Pulse Avalanche Current ^(Note 3)	I_{AS}	7			A
Total Power Dissipation	P_D	25	25	4.17	W
@ $T_c = 25^\circ C$		Derate above $T_c = 25^\circ C$			
Dissipation		0.2	0.2	0.014	W/ $^\circ C$
Operating Junction Temperature	T_J	150			$^\circ C$
Storage Temperature Range	T_{STG}	-55 to +150			$^\circ C$



Thermal Performance

Parameter	Symbol	Limit			Unit
		IPAK	DKPAK	SOT-223	
Thermal Resistance - Junction to Case	$R_{\theta JC}$	5	5	30	°C/W
Thermal Resistance - Junction to Ambient	$R_{\theta JA}$	62	62	70	°C/W

Electrical Specifications ($T_C = 25^\circ\text{C}$ unless otherwise noted)

Parameter	Conditions	Symbol	Min	Typ	Max	Unit
Static						
Drain-Source Breakdown Voltage	$V_{GS} = 0V, I_D = 250\mu A$	BV_{DSS}	60	--	--	V
Drain-Source On-State Resistance	$V_{GS} = 10V, I_D = 6A$	$R_{DS(ON)}$	--	76	90	mΩ
	$V_{GS} = 4.5V, I_D = 3A$		--	87	100	
Gate Threshold Voltage	$V_{DS} = V_{GS}, I_D = 250\mu A$	$V_{GS(TH)}$	1.2	1.8	2.5	V
Zero Gate Voltage Drain Current	$V_{DS} = 60V, V_{GS} = 0V$	I_{DSS}	--	--	1	μA
	$V_{DS} = 48V, T_J = 125^\circ\text{C}$		--	--	10	
Gate Body Leakage	$V_{GS} = \pm 20V, V_{DS} = 0V$	I_{GSS}	--	--	±100	μA
Forward Transconductance	$V_{DS} = 10V, I_D = 3A$	g_{fs}	--	4	--	S

Dynamic						
Total Gate Charge ^(Note 4,5)	$V_{DS} = 48V, I_D = 6A, V_{GS} = 10V$	Q_g	--	9.3	--	nC
Gate-Source Charge ^(Note 4,5)		Q_{gs}	--	2.1	--	
Gate-Drain Charge ^(Note 4,5)		Q_{gd}	--	1.8	--	
Input Capacitance	$V_{DS} = 15V, V_{GS} = 0V, f = 1\text{MHz}$	C_{iss}	--	500	--	pF
Output Capacitance		C_{oss}	--	45	--	
Reverse Transfer Capacitance		C_{rss}	--	16	--	
Gate Resistance	$V_{GS}=0V, V_{DS}=0V, f=1\text{MHz}$	R_g	--	2	--	Ω

Switching						
Turn-On Delay Time ^(Note 4,5)	$V_{DD} = 30V, V_{GS} = 10V, R_G = 3.3\Omega, I_D = -1A$	$t_{d(on)}$	--	2.9	--	ns
Turn-On Rise Time ^(Note 4,5)		t_r	--	9.5	--	
Turn-Off Delay Time ^(Note 4,5)		$t_{d(off)}$	--	18.4	--	
Turn-Off Fall Time ^(Note 4,5)		t_f	--	5.3	--	

Source-Drain Diode Ratings and Characteristic						
Continuous Drain-Source Diode	$V_G = V_D = 0V, \text{Force Current}$	I_S	--	--	11	A
Pulse Drain-Source Diode		I_{SM}	--	--	44	A
Diode-Source Forward Voltage	$V_{GS} = 0V, I_S = 1A$	V_{SD}	--	--	1.2	V
Reverse Recovery Time ^(Note 4)	$V_{GS} = 30V, I_S = 1A$	t_{rr}	--	23.2	--	ns
Reverse Recovery Charge ^(Note 4)		$dI_F/dt = 100A/\mu s$	Q_{rr}	--	14.3	--

Note:

- Limited by maximum junction temperature.
- Repetitive Rating : Pulsed width limited by maximum junction temperature.
- $V_{DD}=25V, V_{GS}=10V, L=1mH, I_{AS}=7A, R_G=25\Omega, \text{Starting } T_J= 25^\circ\text{C}$
- Pulse test: pulse width $\leq 300\mu s$, duty cycle $\leq 2\%$
- Essentially independent of operating temperature.

Electrical Characteristics Curve

Continuous Drain Current vs. T_C

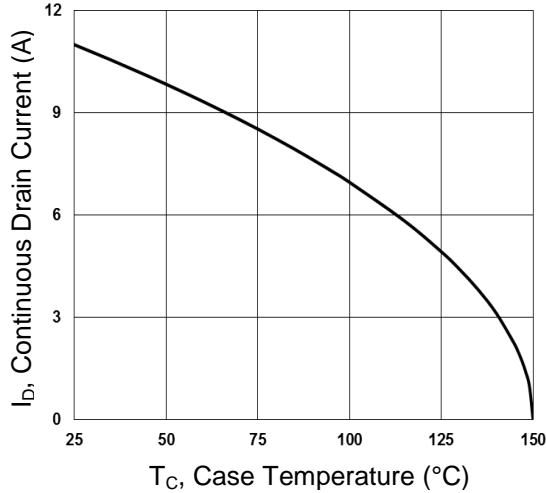

Normalized R_{DS(on)} vs. T_J

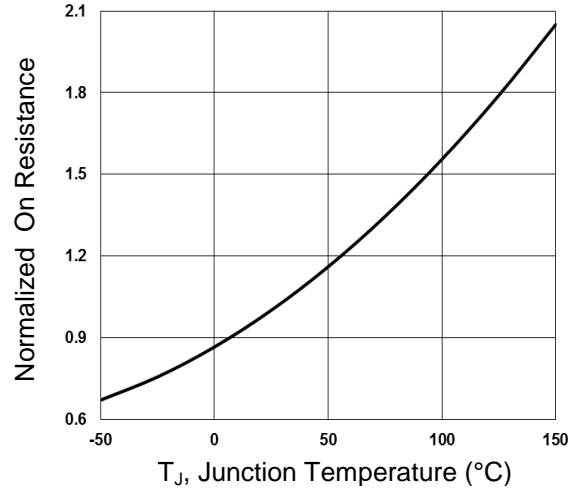

Normalized V_{th} vs. T_J

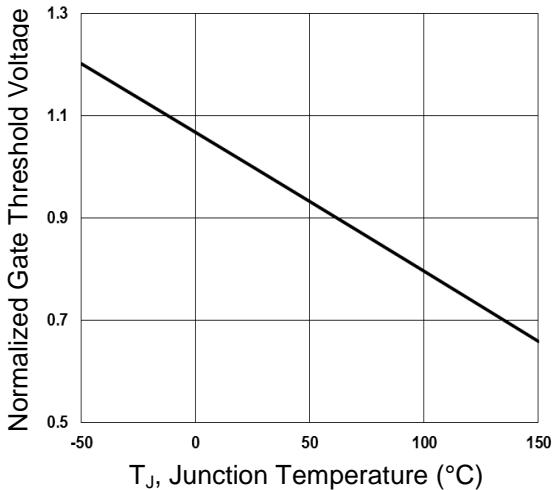

Gate Charge Waveform

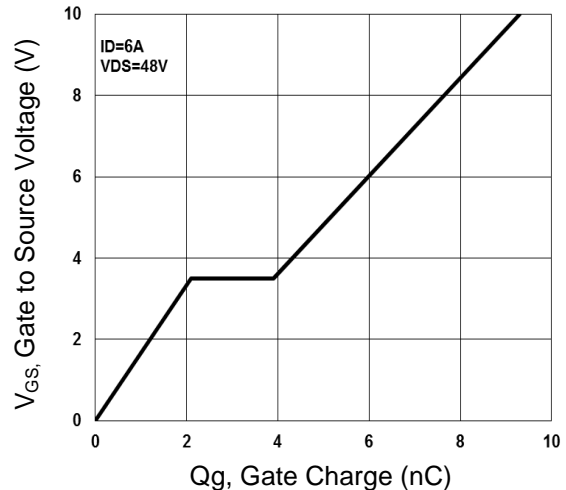

Normalized Transient Impedance (TO-251S)

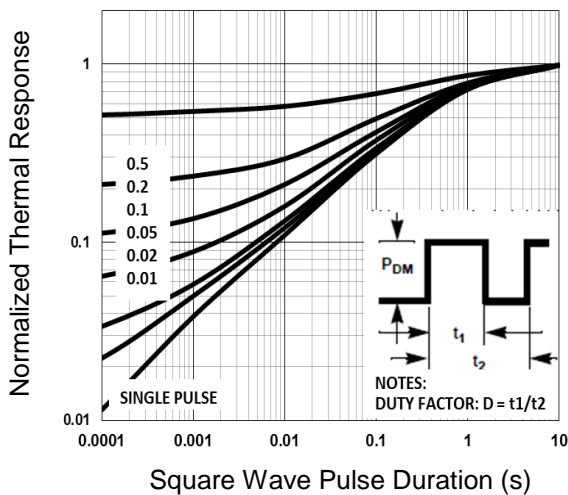

Maximum Safe Operation Area (TO-251S)

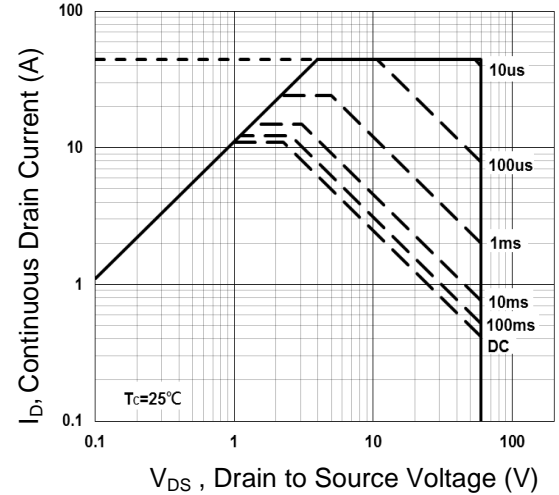

Electrical Characteristics Curve ($T_c=25^\circ\text{C}$, unless otherwise noted)

Normalized Transient Impedance (TO-252)

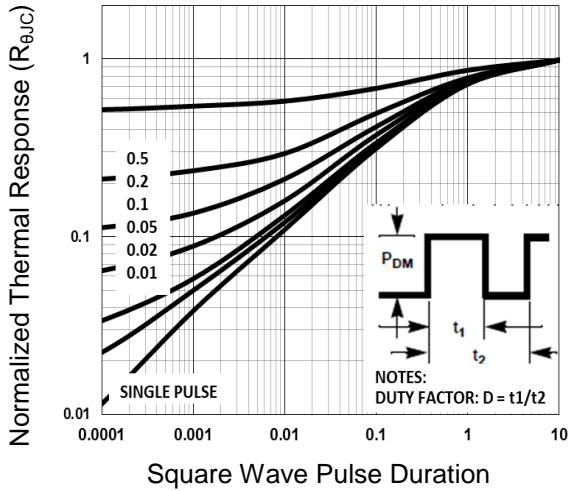

Maximum Safe Operation Area (TO-252)

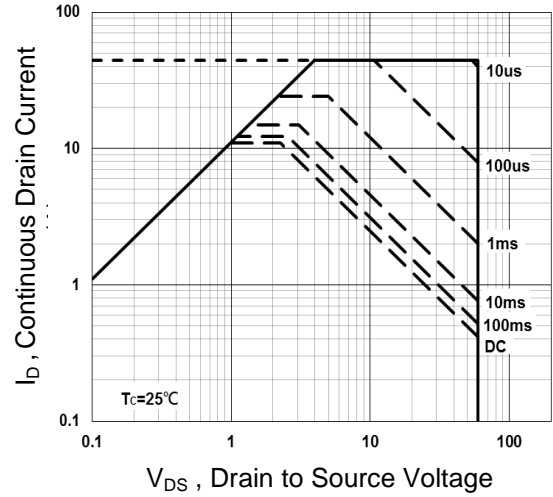

Normalized Transient Impedance (SOT-223)

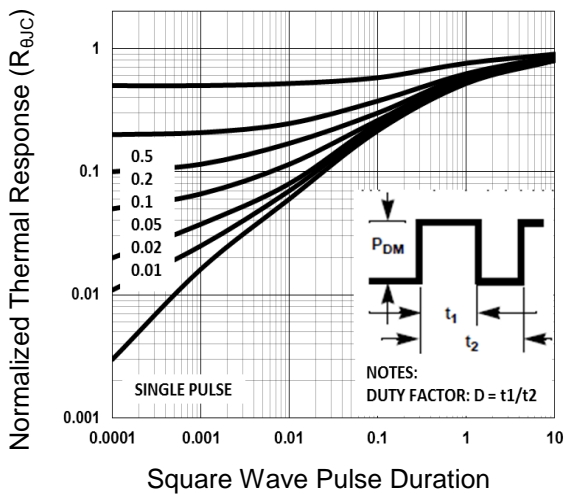

Maximum Safe Operation Area (SOT-223)

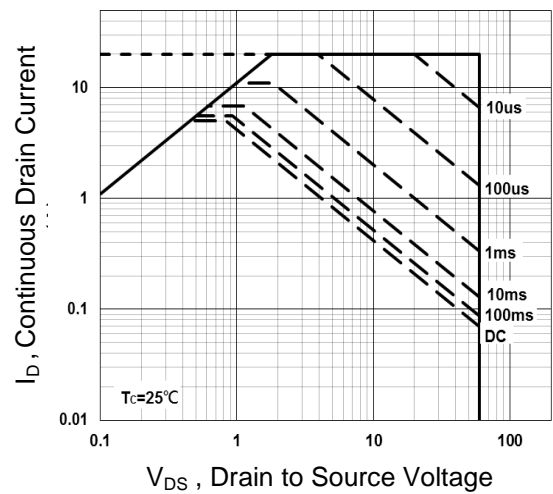



TO-251S Mechanical Drawing

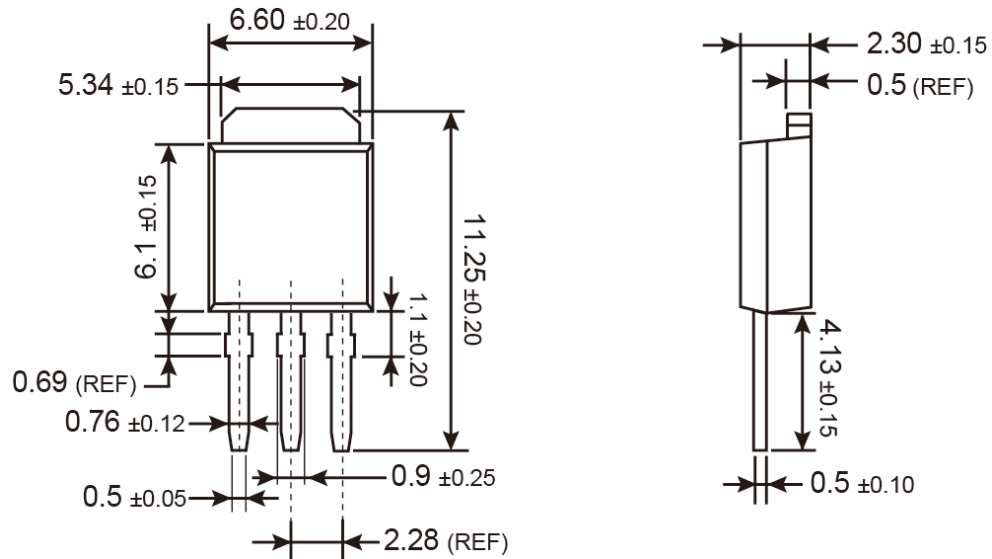

Unit: Millimeters

Marking Diagram

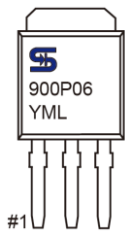

- Y** = Year Code
- M** = Month Code for Halogen Free Product
(O=Jan, P=Feb, Q=Mar, R=Apr, S=May, T=Jun, U=Jul, V=Aug, W=Sep, X=Oct, Y=Nov, Z=Dec)
- L** = Lot Code



TO-252 Mechanical Drawing

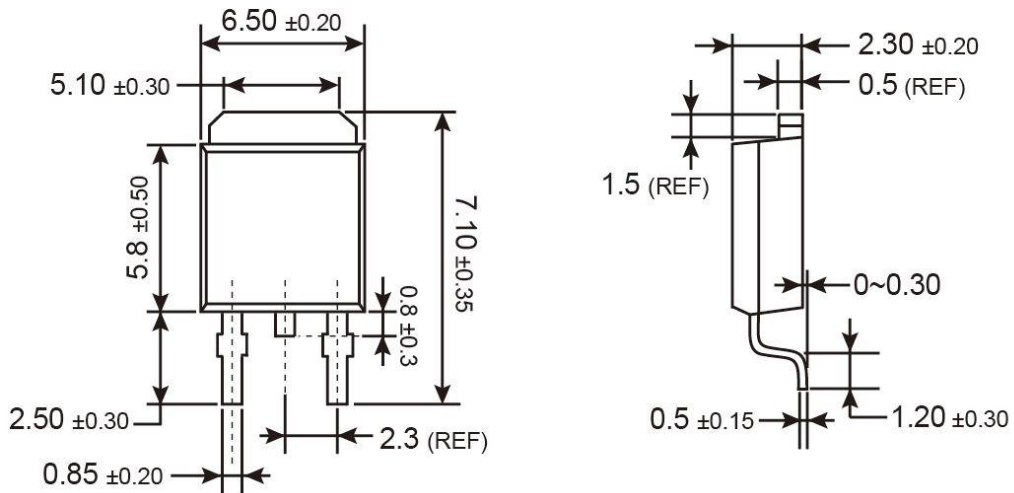

Unit: Millimeters

Marking Diagram

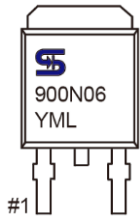

- Y** = Year Code
- M** = Month Code for Halogen Free Product
(O=Jan, P=Feb, Q=Mar, R=Apr, S=May, T=Jun, U=Jul, V=Aug, W=Sep, X=Oct, Y=Nov, Z=Dec)
- L** = Lot Code



SOT-223 Mechanical Drawing

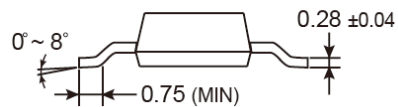
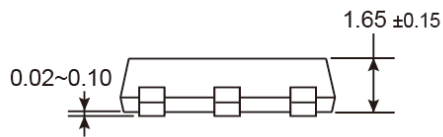
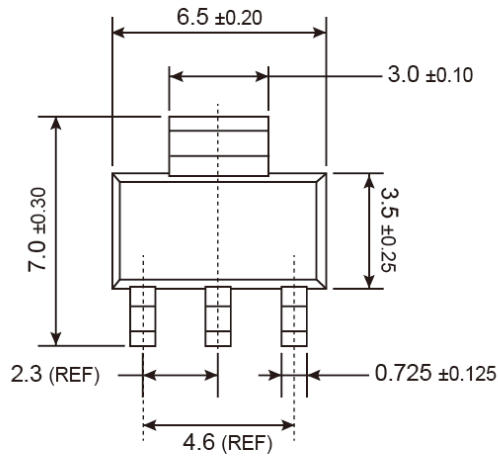

Unit: Millimeters

Marking Diagram

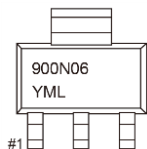

- Y** = Year Code
- M** = Month Code for Halogen Free Product
(**O**=Jan, **P**=Feb, **Q**=Mar, **R**=Apr, **S**=May, **T**=Jun, **U**=Jul, **V**=Aug, **W**=Sep, **X**=Oct, **Y**=Nov, **Z**=Dec)
- L** = Lot Code

Notice

Specifications of the products displayed herein are subject to change without notice. TSC or anyone on its behalf, assumes no responsibility or liability for any errors or inaccuracies.

Information contained herein is intended to provide a product description only. No license, express or implied, to any intellectual property rights is granted by this document. Except as provided in TSC's terms and conditions of sale for such products, TSC assumes no liability whatsoever, and disclaims any express or implied warranty, relating to sale and/or use of TSC products including liability or warranties relating to fitness for a particular purpose, merchantability, or infringement of any patent, copyright, or other intellectual property right.

The products shown herein are not designed for use in medical, life-saving, or life-sustaining applications. Customers using or selling these products for use in such applications do so at their own risk and agree to fully indemnify TSC for any damages resulting from such improper use or sale.