



## Smart Power High-Side-Switch

### Features

- Overload protection
- Current limitation
- Short circuit protection
- Thermal shutdown with restart
- Overvoltage protection (including load dump)
- Fast demagnetization of inductive loads
- Reverse battery protection with external resistor
- CMOS compatible input
- Loss of GND and loss of  $V_{bb}$  protection
- ESD - Protection
- Very low standby current
  - AEC qualified
  - Green product (RoHS compliant)

### Product Summary

Overvoltage protection	$V_{bb(AZ)}$	41	V
Operating voltage	$V_{bb(on)}$	5...34	V
On-state resistance	$R_{ON}$	100	m $\Omega$
Nominal load current	$I_{L(nom)}$	2	A



PG-DSO8

### Application

- All types of resistive, inductive and capacitive loads
- $\mu$ C compatible power switch for 12 V and 24 V DC applications
- Replaces electromechanical relays and discrete circuits

### General Description

N channel vertical power FET with charge pump, ground referenced CMOS compatible input, monolithically integrated in Smart SIPMOS<sup>®</sup> technology.

Providing embedded protective functions.

### Block Diagram



Pin	Symbol	Function
1	GND	Logic ground
2	IN	Input, activates the power switch in case of logic high signal
3	OUT	Output to the load
4	NC	not connected
5	Vbb	Positive power supply voltage
6	Vbb	Positive power supply voltage
7	Vbb	Positive power supply voltage
8	Vbb	Positive power supply voltage

### Pin configuration

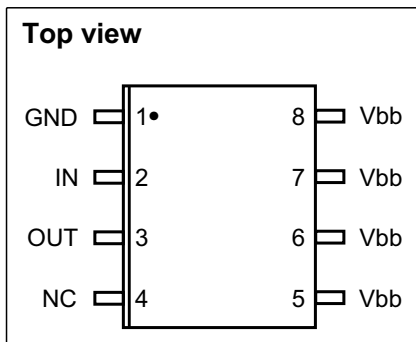

**Maximum Ratings** at  $T_j = 25^\circ\text{C}$ , unless otherwise specified

Parameter	Symbol	Value	Unit
Supply voltage	$V_{bb}$	40	V
Supply voltage for full short circuit protection $T_j = -40\dots+150^\circ\text{C}$	$V_{bb(SC)}$	$V_{bb}$	
Continuous input voltage	$V_{IN}$	-10 ... +16	
Load current (Short - circuit current, see page 5)	$I_L$	self limited	A
Current through input pin (DC)	$I_{IN}$	$\pm 5$	mA
Operating temperature	$T_j$	-40 ...+150	$^\circ\text{C}$
Storage temperature	$T_{stg}$	-55 ... +150	
Power dissipation <sup>1)</sup>	$P_{tot}$	1.5	W
Inductive load switch-off energy dissipation <sup>1)2)</sup> single pulse, (see page 8) $T_j = 150^\circ\text{C}$ , $V_{bb} = 13.5\text{ V}$ , $I_L = 1\text{ A}$	$E_{AS}$	870	mJ
Load dump protection <sup>2)</sup> $V_{LoadDump}^{3)} = V_A + V_S$ $R_I = 2\Omega$ , $t_d = 400\text{ms}$ , $V_{IN} = \text{low or high}$ , $V_A = 13,5\text{V}$ $R_L = 13.5\ \Omega$	$V_{Loaddump}$	60	V
<b>Electrostatic discharge voltage</b> (Human Body Model) according to ANSI EOS/ESD - S5.1 - 1993 ESD STM5.1 - 1998	$V_{ESD}$		kV
Input pin		$\pm 1$	
all other pins		$\pm 5$	

**Thermal Characteristics**

Thermal resistance @ min. footprint	$R_{th(JA)}$	-	95	-	K/W
Thermal resistance @ 6 cm <sup>2</sup> cooling area <sup>1)</sup>	$R_{th(JA)}$	-	70	83	

<sup>1)</sup> Device on 50mm\*50mm\*1.5mm epoxy PCB FR4 with 6 cm<sup>2</sup> (one layer, 70µm thick) copper area for drain connection. PCB is vertical without blown air. (see page 16)

<sup>2)</sup> not subject to production test, specified by design

<sup>3)</sup>  $V_{Loaddump}$  is setup without the DUT connected to the generator per ISO 7637-1 and DIN 40839 .

Supply voltages higher than  $V_{bb(AZ)}$  require an external current limit for the GND pin, e.g. with a 150Ω resistor in GND connection. A resistor for the protection of the input is integrated.

**Electrical Characteristics**

Parameter and Conditions	Symbol	Values			Unit
		min.	typ.	max.	
at $T_j = -40\dots+150^\circ\text{C}$ , $V_{bb} = 13,5\text{V}$ , unless otherwise specified					

**Load Switching Capabilities and Characteristics**

On-state resistance $T_j = 25^\circ\text{C}$ , $I_L = 2\text{A}$ , $V_{bb} = 9\dots40\text{V}$ $T_j = 150^\circ\text{C}$	$R_{ON}$	-	70 140	100 200	m $\Omega$
Nominal load current; Device on PCB <sup>1)</sup> $T_C = 85^\circ\text{C}$ , $T_j \leq 150^\circ\text{C}$	$I_{L(nom)}$	2	2.4	-	A
Turn-on time to 90% $V_{OUT}$ $R_L = 47\ \Omega$	$t_{on}$	-	90	170	$\mu\text{s}$
Turn-off time to 10% $V_{OUT}$ $R_L = 47\ \Omega$	$t_{off}$	-	90	230	
Slew rate on 10 to 30% $V_{OUT}$ , $R_L = 47\ \Omega$	$dV/dt_{on}$	-	0.8	1.7	V/ $\mu\text{s}$
Slew rate off 70 to 40% $V_{OUT}$ , $R_L = 47\ \Omega$	$-dV/dt_{off}$	-	0.8	1.7	

**Operating Parameters**

Operating voltage	$V_{bb(on)}$	5	-	34	V
Undervoltage shutdown of charge pump $T_j = -40\dots+85^\circ\text{C}$ $T_j = 150^\circ\text{C}$	$V_{bb(under)}$	-	-	4 5.5	
Undervoltage restart of charge pump	$V_{bb(u_{cp})}$	-	4	5.5	
Standby current $T_j = -40\dots+85^\circ\text{C}$ , $V_{IN} = 0\text{V}$ $T_j = 150^\circ\text{C}^2)$ , $V_{IN} = 0\text{V}$	$I_{bb(off)}$	-	-	10 15	$\mu\text{A}$
Leakage output current (included in $I_{bb(off)}$ ) $V_{IN} = 0\text{V}$	$I_{L(off)}$	-	-	5	
Operating current $V_{IN} = 5\text{V}$	$I_{GND}$	-	0.5	1.3	mA

<sup>1</sup>Device on 50mm\*50mm\*1.5mm epoxy PCB FR4 with 6 cm<sup>2</sup> (one layer, 70 $\mu\text{m}$  thick) copper area for drain connection. PCB is vertical without blown air. (see page 16)

<sup>2</sup>higher current due temperature sensor

**Electrical Characteristics**

Parameter and Conditions at $T_j = -40\dots+150^\circ\text{C}$ , $V_{bb} = 13,5\text{V}$ , unless otherwise specified	Symbol	Values			Unit
		min.	typ.	max.	

**Protection Functions<sup>1)</sup>**

Initial peak short circuit current limit (pin 5 to 3) $T_j = -40^\circ\text{C}$ , $V_{bb} = 20\text{V}$ , $t_m = 150\ \mu\text{s}$ $T_j = 25^\circ\text{C}$ $T_j = 150^\circ\text{C}$	$I_{L(SCp)}$	- - 4	- 10 -	18 - -	A
Repetitive short circuit current limit $T_j = T_{jt}$ (see timing diagrams)	$I_{L(SCr)}$	-	7	-	
Output clamp (inductive load switch off) at $V_{OUT} = V_{bb} - V_{ON(CL)}$ , $I_{bb} = 4\text{mA}$	$V_{ON(CL)}$	41	47	-	V
Overvoltage protection <sup>2)</sup> $I_{bb} = 4\text{mA}$	$V_{bb(AZ)}$	41	-	-	
Thermal overload trip temperature	$T_{jt}$	150	-	-	$^\circ\text{C}$
Thermal hysteresis	$\Delta T_{jt}$	-	10	-	K

**Reverse Battery**

Reverse battery <sup>3)</sup>	$-V_{bb}$	-	-	32	V
Drain-source diode voltage ( $V_{OUT} > V_{bb}$ ) $T_j = 150^\circ\text{C}$	$-V_{ON}$	-	600	-	mV

<sup>1)</sup>Integrated protection functions are designed to prevent IC destruction under fault conditions described in the data sheet. Fault conditions are considered as "outside" normal operating range. Protection functions are not designed for continuous repetitive operation.

<sup>2)</sup> see also  $V_{ON(CL)}$  in circuit diagram on page 7

<sup>3)</sup>Requires a  $150\ \Omega$  resistor in GND connection. The reverse load current through the intrinsic drain-source diode has to be limited by the connected load. Power dissipation is higher compared to normal operating conditions due to the voltage drop across the drain-source diode. The temperature protection is not active during reverse current operation! Input current has to be limited (see max. ratings page 3).

**Electrical Characteristics**

Parameter and Conditions at $T_j = -40...+150^{\circ}\text{C}$ , $V_{bb} = 13,5\text{V}$ , unless otherwise specified	Symbol	Values			Unit
		min.	typ.	max.	
<b>Input</b>					
Input turn-on threshold voltage (see page 12)	$V_{IN(T+)}$	-	-	2.2	V
Input turn-off threshold voltage (see page 12)	$V_{IN(T-)}$	0.8	-	-	
Input threshold hysteresis	$\Delta V_{IN(T)}$	-	0.3	-	
Off state input current (see page 12) $V_{IN} = 0.7\text{ V}$	$I_{IN(off)}$	1	-	25	$\mu\text{A}$
On state input current (see page 12) $V_{IN} = 5\text{ V}$	$I_{IN(on)}$	3	-	25	
Input resistance (see page 7)	$R_I$	1.5	3.5	5	$\text{k}\Omega$

**Terms**



**Inductive and overvoltage output clamp**

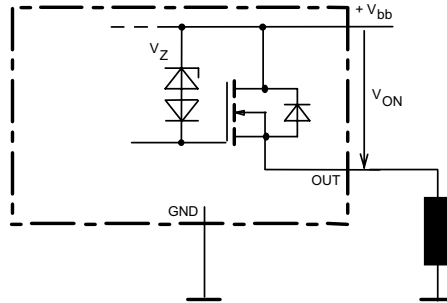

$V_{ON}$  clamped to 47V typ.

**Input circuit (ESD protection)**

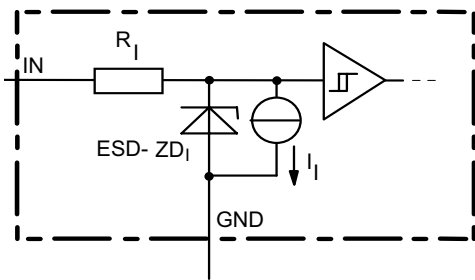

The use of ESD zener diodes as voltage clamp at DC conditions is not recommended

**Overvoltage protection of logic part**



$V_{Z1}=6.1V$  typ.,  $V_{Z2}=V_{bb(AZ)}=47V$  typ.,  
 $R_I=3.5\text{ k}\Omega$  typ.,  $R_{GND}=150\Omega$

**Reverse battery protection**



$R_{GND}=150\Omega$ ,  $R_I=3.5\text{ k}\Omega$  typ.,  
Temperature protection is not active during inverse current

**GND disconnect**



**V<sub>bb</sub> disconnect with charged inductive load**



**GND disconnect with GND pull up**



**Inductive Load switch-off energy dissipation**



Energy stored in load inductance:  $E_L = \frac{1}{2} * L * I_L^2$

While demagnetizing load inductance, the energy dissipated in PROFET is  $E_{AS} = E_{bb} + E_L - E_R = V_{ON(CL)} * i_L(t) dt$ , with an approximate solution for  $R_L > 0\Omega$ :

$$E_{AS} = \frac{I_L * L}{2 * R_L} * (V_{bb} + |V_{OUT(CL)}|) * \ln\left(1 + \frac{I_L * R_L}{|V_{OUT(CL)}|}\right)$$



Typ. transient thermal impedance

$Z_{thJA} = f(t_p)$  @ 6cm<sup>2</sup> heatsink area

Parameter:  $D = t_p / T$



Typ. transient thermal impedance

$Z_{thJA} = f(t_p)$  @ min. footprint

Parameter:  $D = t_p / T$

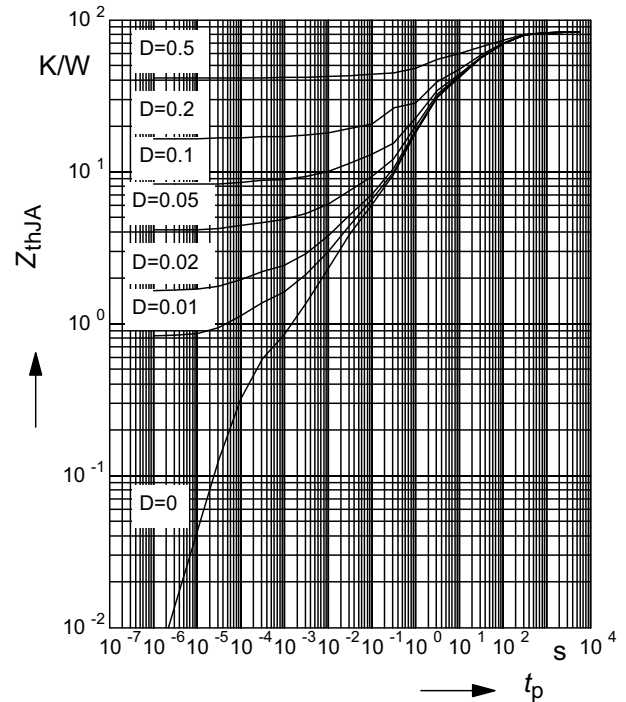

Typ. on-state resistance

$R_{ON} = f(T_j)$ ;  $V_{bb} = 13,5V$ ;  $V_{in} = \text{high}$

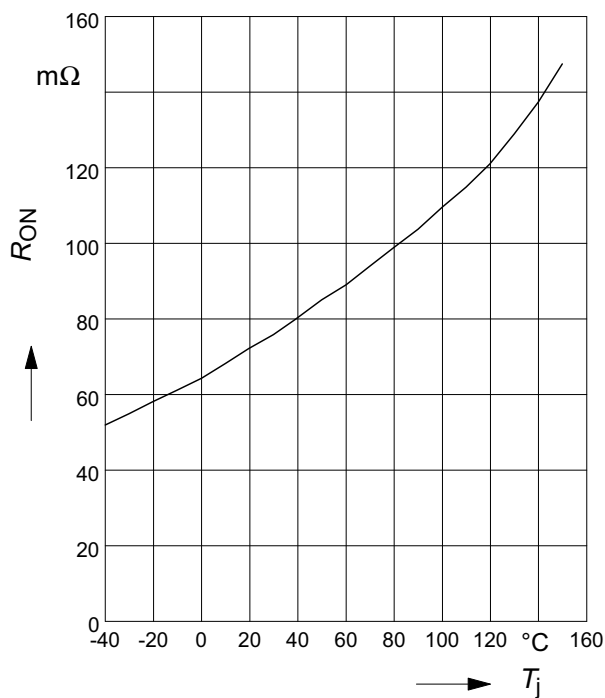

Typ. on-state resistance

$R_{ON} = f(V_{bb})$ ;  $I_L = 0.5A$ ;  $V_{in} = \text{high}$

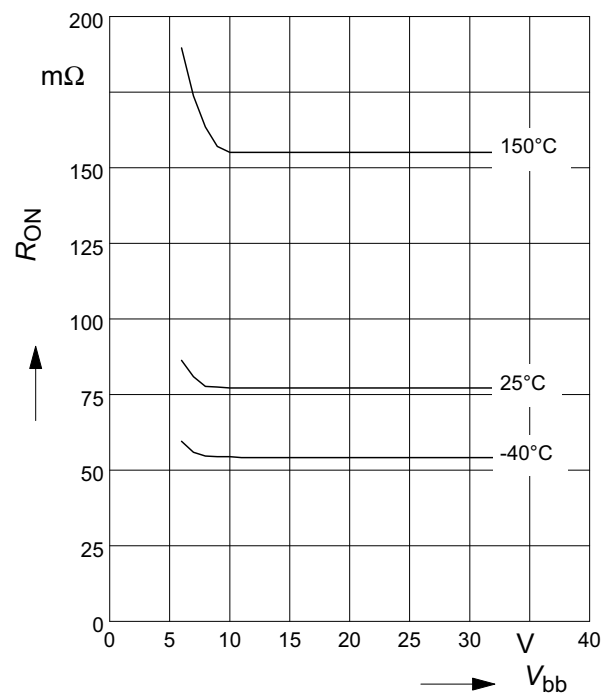

**Typ. turn on time**

$t_{on} = f(T_j); R_L = 47\Omega$

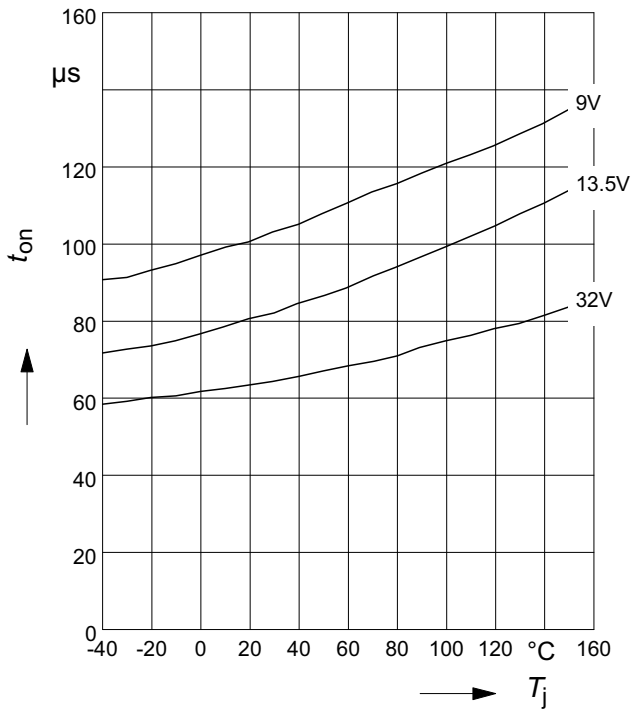

**Typ. turn off time**

$t_{off} = f(T_j); R_L = 47\Omega$

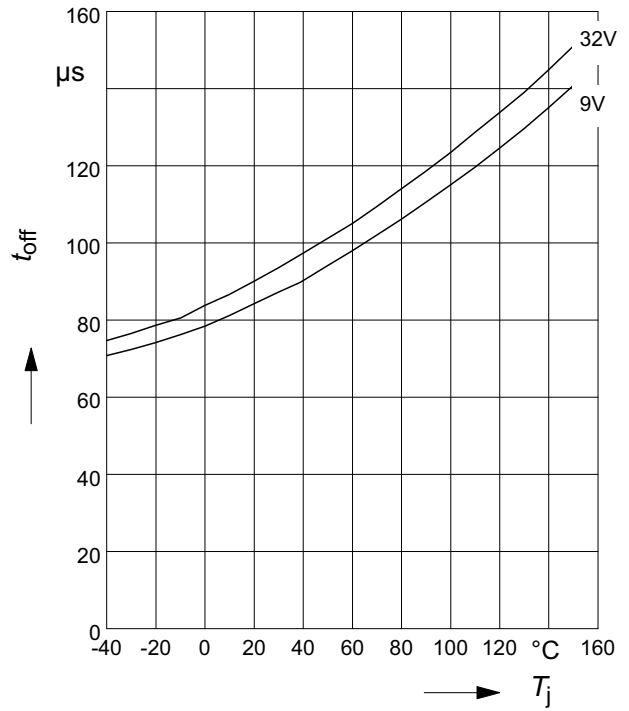

**Typ. slew rate on**

$dV/dt_{on} = f(T_j); R_L = 47\Omega$

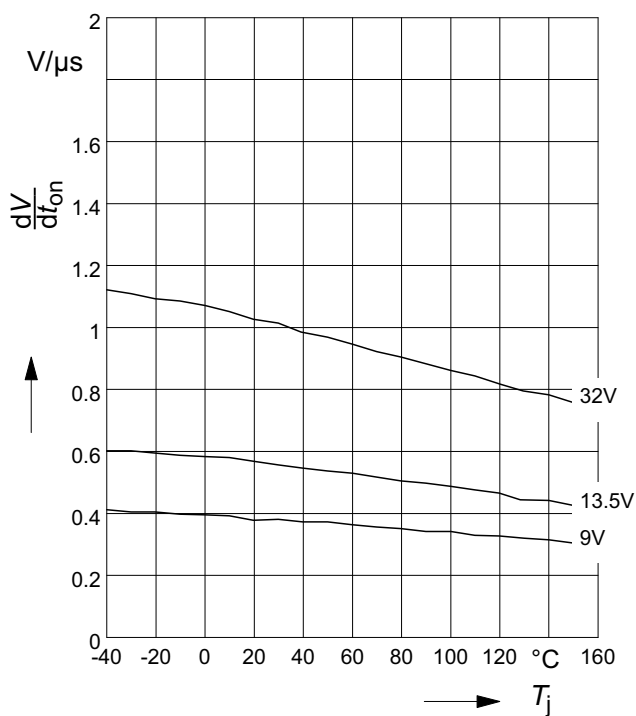

**Typ. slew rate off**

$-dV/dt_{off} = f(T_j); R_L = 47\Omega$

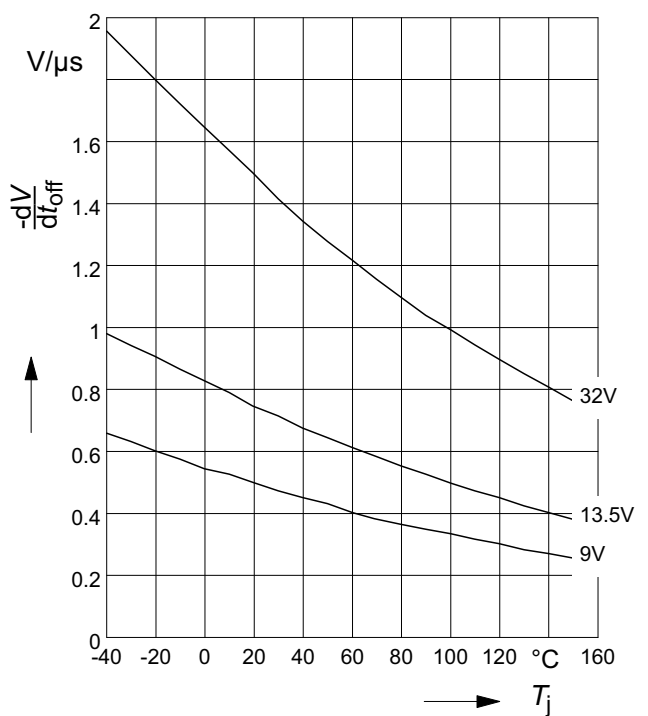

**Typ. standby current**

$I_{bb(off)} = f(T_j) ; V_{bb} = 32V ; V_{IN} = low$

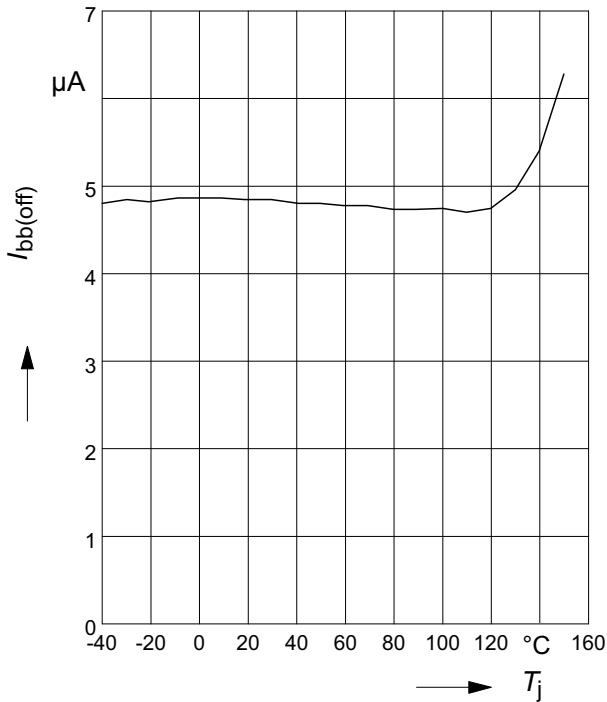

**Typ. leakage current**

$I_{L(off)} = f(T_j) ; V_{bb} = 32V ; V_{IN} = low$

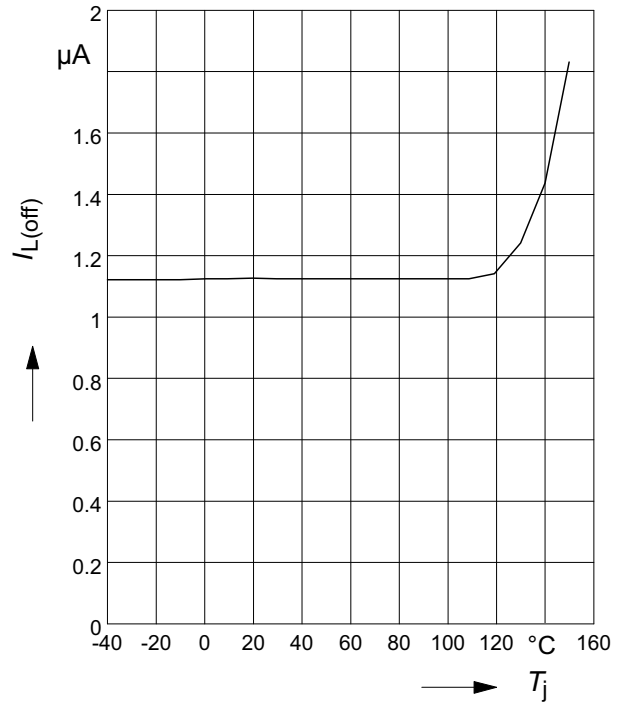

**Typ. initial peak short circuit current limit**

$I_{L(SCp)} = f(T_j) ; V_{bb} = 20V$

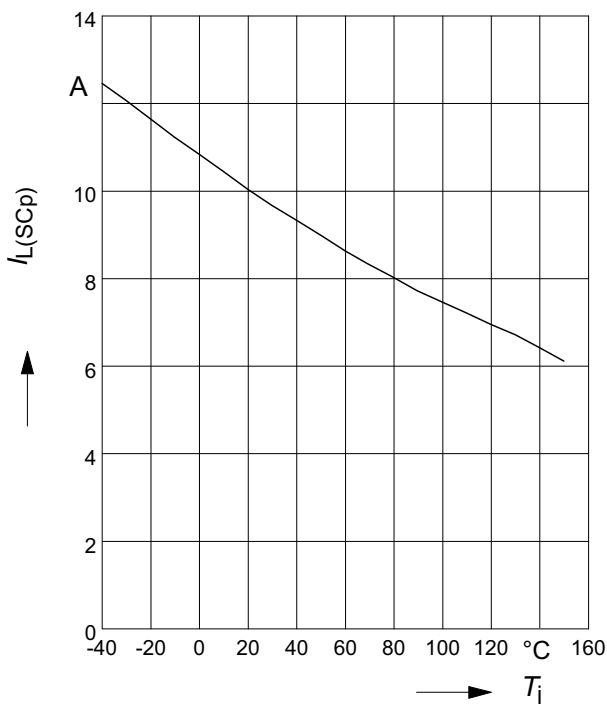

**Typ. initial short circuit shutdown time**

$t_{off(SC)} = f(T_{j,start}) ; V_{bb} = 20V$

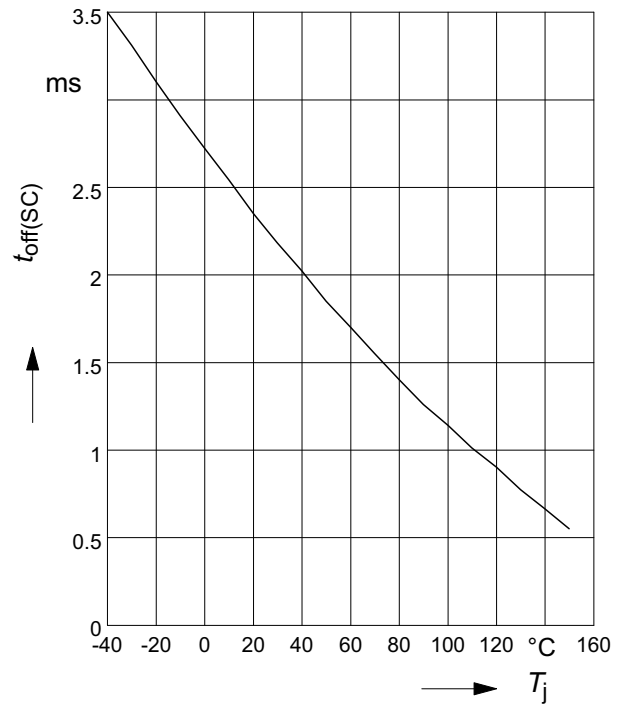

**Typ. input current**

$I_{IN(on/off)} = f(T_j)$ ;  $V_{bb} = 13,5V$ ;  $V_{IN} = \text{low/high}$   
 $V_{INlow} \leq 0,7V$ ;  $V_{INhigh} = 5V$

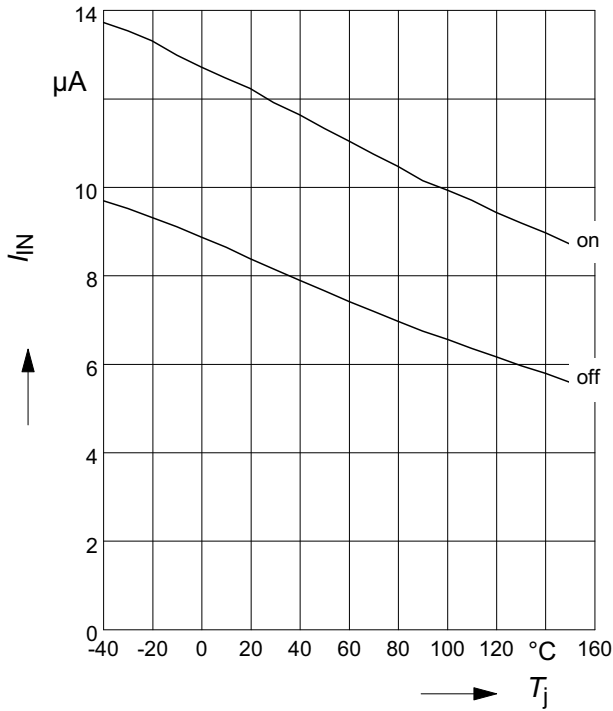

**Typ. input threshold voltage**

$V_{IN(th)} = f(T_j)$ ;  $V_{bb} = 13,5V$

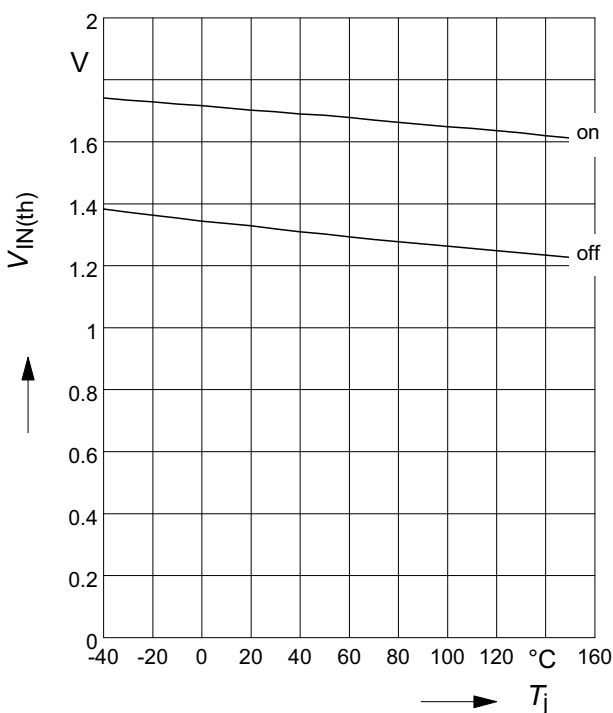

**Typ. input current**

$I_{IN} = f(V_{IN})$ ;  $V_{bb} = 13.5V$

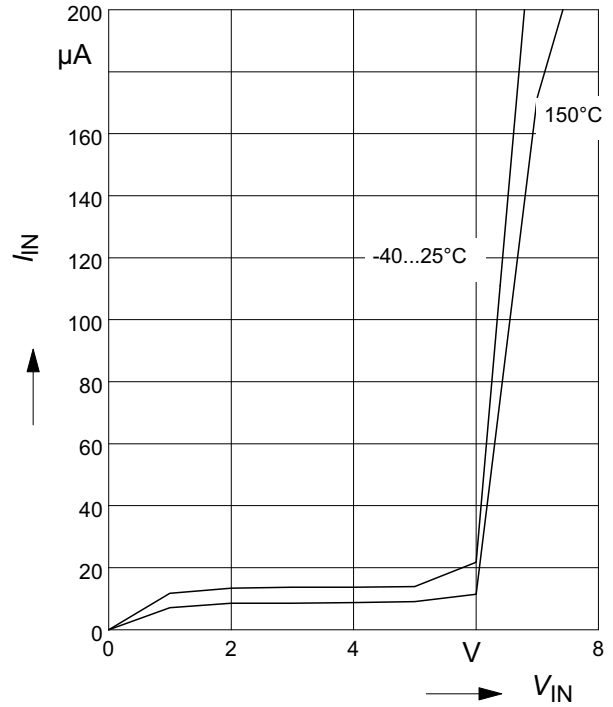

**Typ. input threshold voltage**

$V_{IN(th)} = f(V_{bb})$ ;  $T_j = 25^{\circ}C$

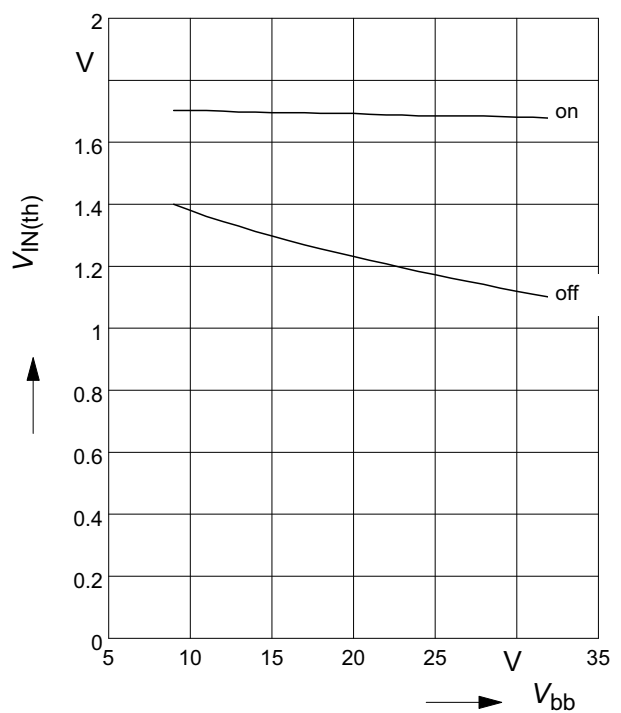

**Maximum allowable load inductance  
for a single switch off**

$L = f(I_L); T_{jstart}=150^{\circ}\text{C}, V_{bb}=13.5\text{V}, R_L=0\Omega$

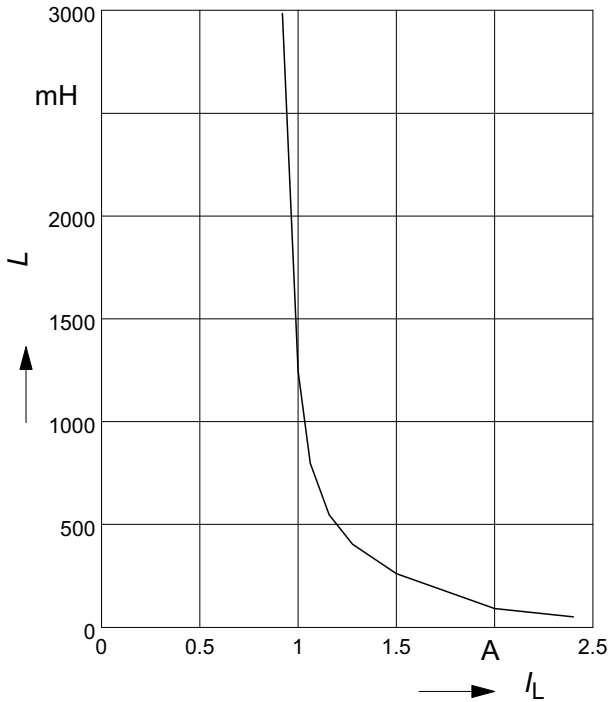

**Maximum allowable inductive switch-off  
energy, single pulse**

$E_{AS} = f(I_L); T_{jstart} = 150^{\circ}\text{C}, V_{bb} = 13,5\text{V}$

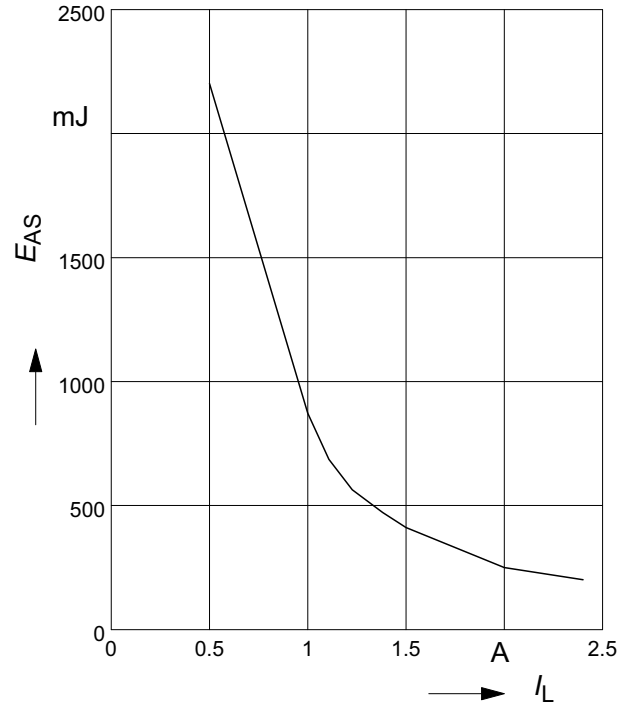
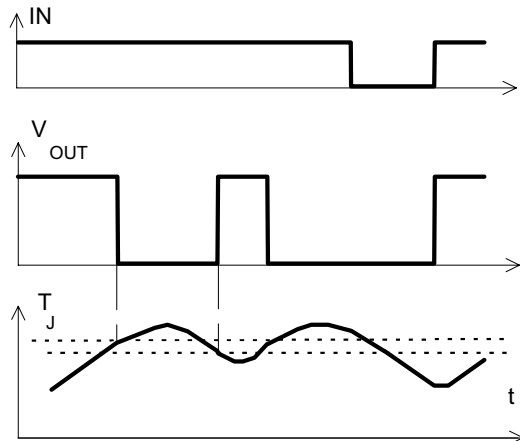

**Figure 3a:** Turn on into short circuit, shut down by overtemperature, restart by cooling



Heating up of the chip may require several milliseconds, depending on external conditions.

**Figure 4:** Overtemperature:  
Reset if  $T_j < T_{jt}$



**Figure 5:** Undervoltage restart of charge pump

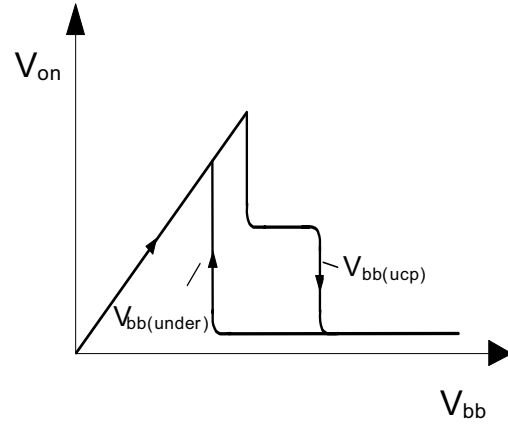

## Package Outlines



**Figure 1** PG-DSO-8-24 (Plastic Dual Small Outline Package) (RoHS-compliant)

To meet the world-wide customer requirements for environmentally friendly products and to be compliant with government regulations the device is available as a green product. Green products are RoHS-Compliant (i.e Pb-free finish on leads and suitable for Pb-free soldering according to IPC/JEDEC J-STD-020).

Please specify the package needed (e.g. green package) when placing an order

## Revision History

Version	Date	Changes
V1.1	2007-05-29	Creation of the green datasheet. First page : Adding the green logo and the AEC qualified Adding the bullet AEC qualified and the RoHS compliant features Package page Modification of the package to be green.



**Edition 2007-05-29**

**Published by  
Infineon Technologies AG  
81726 Munich, Germany**

**© Infineon Technologies AG 5/29/07.  
All Rights Reserved.**

### **Legal Disclaimer**

The information given in this document shall in no event be regarded as a guarantee of conditions or characteristics ("Beschaffenhheitsgarantie"). With respect to any examples or hints given herein, any typical values stated herein and/or any information regarding the application of the device, Infineon Technologies hereby disclaims any and all warranties and liabilities of any kind, including without limitation warranties of non-infringement of intellectual property rights of any third party.

### **Information**

For further information on technology, delivery terms and conditions and prices please contact your nearest Infineon Technologies Office ([www.infineon.com](http://www.infineon.com)).

### **Warnings**

Due to technical requirements components may contain dangerous substances. For information on the types in question please contact your nearest Infineon Technologies Office.

Infineon Technologies Components may only be used in life-support devices or systems with the express written approval of Infineon Technologies, if a failure of such components can reasonably be expected to cause the failure of that life-support device or system, or to affect the safety or effectiveness of that device or system. Life support devices or systems are intended to be implanted in the human body, or to support and/or maintain and sustain and/or protect human life. If they fail, it is reasonable to assume that the health of the user or other persons may be endangered.