

## High and Low Side Driver

### Features

- Floating channel designed for bootstrap operation
- Fully operational to 200V
- Tolerant to negative transient voltage, dV/dt immune
- Gate drive supply range from 10 to 20V
- Independent low and high side channels
- Input logic HIN/LIN active high
- Undervoltage lockout for both channels
- 3.3V and 5V logic compatible
- CMOS Schmitt-triggered inputs with pull-down
- Matched propagation delay for both channels

### Description

The IR2011 is a high power, high speed power MOSFET driver with independent high and low side referenced output channels. Logic inputs are compatible with standard CMOS or LSTTL output, down to 3.0V logic. The output drivers feature a high pulse current buffer stage designed for minimum driver cross-conduction. Propagation delays are matched to simplify use in high frequency applications. The floating channel can be used to drive an N-channel power MOSFET in the high side configuration which operates up to 200 volts. Proprietary HVIC and latch immune CMOS technologies enable ruggedized monolithic construction.

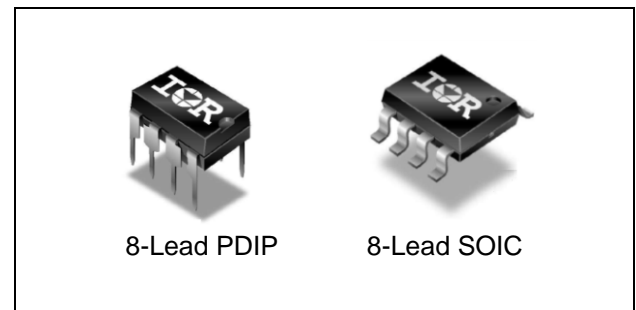
### Applications

- Converters
- DC motor drive

### Product Summary

$V_{\text{OFFSET}}$ (max)	200V
$I_{\text{O+/-}}$ (typ)	1.0A / 1.0A
$V_{\text{OUT}}$	10 – 20V
$t_{\text{on/off}}$ (typ)	80ns & 60ns
Delay Matching (max)	20ns

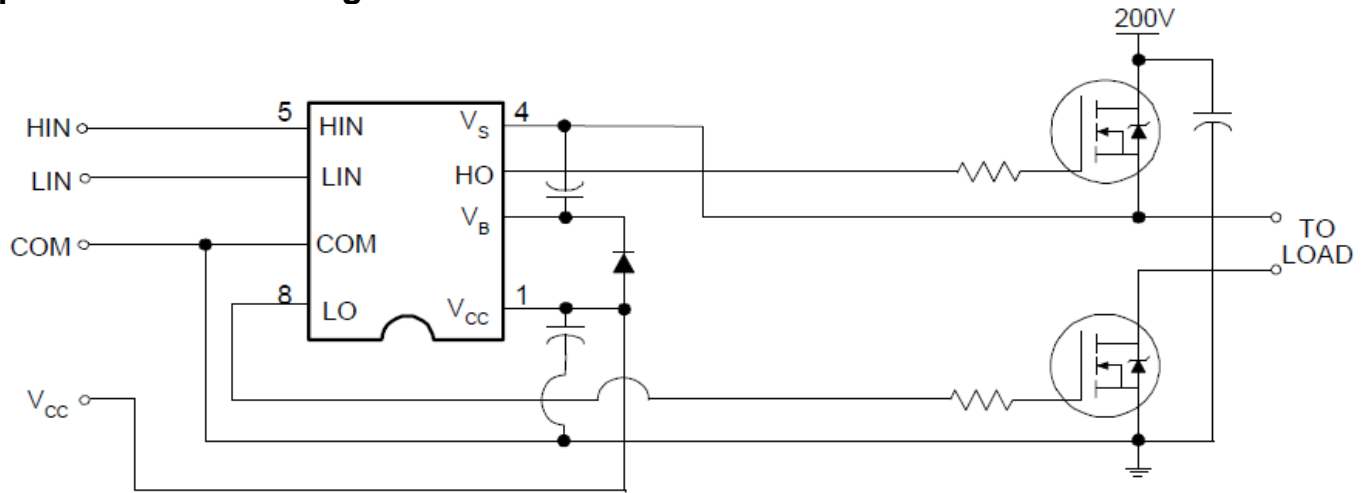
### Package Options



### Ordering Information

Base Part Number	Package Type	Standard Pack		Orderable Part Number
		Form	Quantity	
IR2011PBF	PDIP8	Tube	50	IR2011PBF
IR2011SPBF	SO8N	Tube	95	IR2011SPBF
IR2011SPBF	SO8N	Tape and Reel	2500	IR2011STRPBF

**Typical Connection Diagram**



(Refer to Lead Assignments for correct configuration.) This diagram shows electrical connections only. Please refer to our Application Notes and Design Tips for proper circuit board layout

### Absolute Maximum Ratings

Absolute maximum ratings indicate sustained limits beyond which damage to the device may occur. All voltage parameters are absolute voltages referenced to COM. The thermal resistance and power dissipation ratings are measured under board mounted and still air conditions.

Symbol	Definition	Min.	Max.	Units	
$V_B$	High side floating supply voltage	-0.3	225	V	
$V_S$	High side floating supply offset voltage	$V_B - 25$	$V_B + 0.3$		
$V_{HO}$	High side floating output voltage	$V_S - 0.3$	$V_B + 0.3$		
$V_{CC}$	Low side fixed supply voltage	-0.3	25		
$V_{LO}$	Low side output voltage	-0.3	$V_{CC} + 0.3$		
$V_{IN}$	Logic input voltage (HIN, LIN)	-0.3	$V_{CC} + 0.3$		
$dV_s/dt$	Allowable offset supply voltage transient	—	50	V/ns	
$P_D$	Package power dissipation @ $T_A \leq +25^\circ\text{C}$	8-Lead PDIP	—	1.0	W
		8-Lead SOIC	—	0.625	
$R_{thJA}$	Thermal resistance, junction to ambient	8-Lead PDIP	—	125	$^\circ\text{C/W}$
		8-Lead SOIC	—	200	
$T_J$	Junction temperature	—	150	$^\circ\text{C}$	
$T_S$	Storage temperature	-55	150		
$T_L$	Lead temperature (soldering, 10 seconds)	—	300		

### Recommended Operating Conditions

For proper operation the device should be used within the recommended conditions. The  $V_S$  and COM offset ratings are tested with all supplies biased at 15V differential.

Symbol	Definition	Min.	Max.	Units
$V_B$	High side floating supply absolute voltage	$V_S + 10$	$V_S + 20$	V
$V_S$	High side floating supply offset voltage	†	200	
$V_{HO}$	High side floating output voltage	$V_S$	$V_B$	
$V_{CC}$	Low side fixed supply voltage	10	20	
$V_{LO}$	Low side output voltage	0	$V_{CC}$	
$V_{IN}$	Logic input voltage (HIN, LIN)	COM	5.5	
$T_A$	Ambient temperature	-40	125	$^\circ\text{C}$

† Logic operational for  $V_S$  of -4 to +200V. Logic state held for  $V_S$  of -4V to  $-V_{BS}$ .

### Dynamic Electrical Characteristics

$V_{BIAS}$  ( $V_{CC}$ ,  $V_{BS}$ ) = 15V,  $C_L$  = 1000pF and  $T_A$  = 25°C unless otherwise specified. Figure 1 shows the timing definitions.

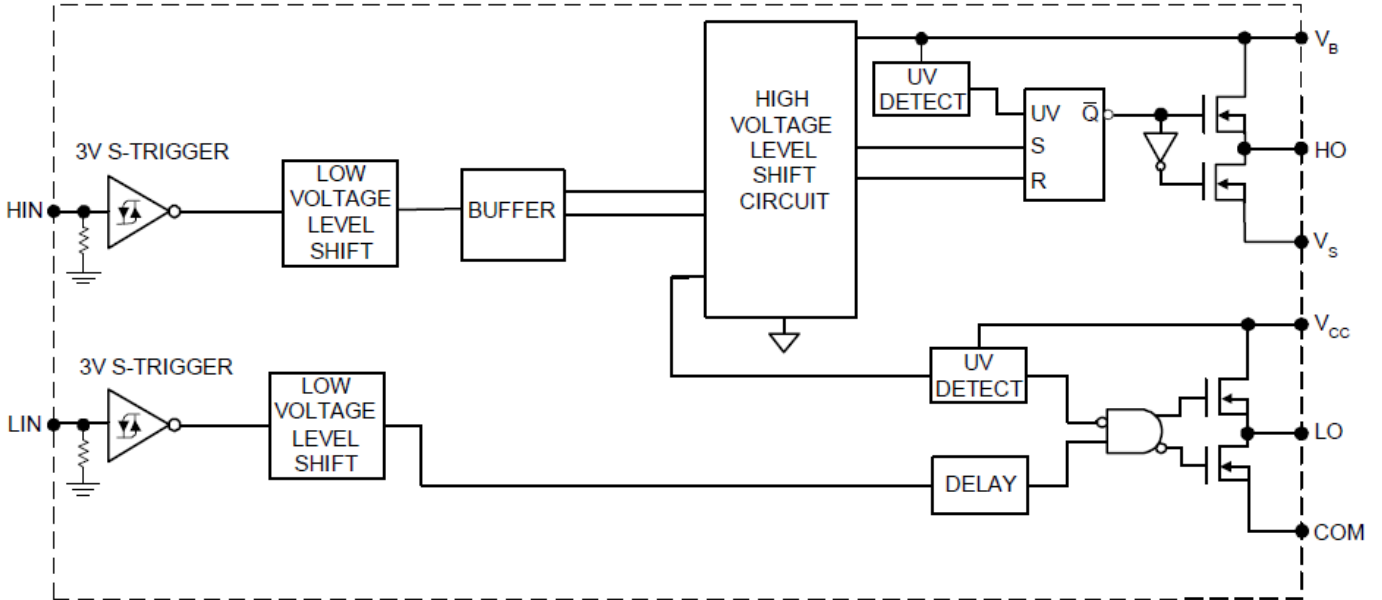
Symbol	Definition	Min.	Typ.	Max.	Units	Test Conditions
$t_{on}$	Turn-on propagation delay	—	80	—	ns	$V_S = 0V$
$t_{off}$	Turn-off propagation delay	—	75	—		$V_S = 200V$
$t_r$	Turn-on rise time	—	35	50		
$t_f$	Turn-off fall time	—	20	35		
DM1	Turn-on delay matching   $t_{on}(H) - t_{on}(L)$	—	—	20		
DM2	Turn-off delay matching   $t_{off}(H) - t_{off}(L)$	—	—	20		

### Static Electrical Characteristics

$V_{BIAS}$  ( $V_{CC}$ ,  $V_{BS}$ ) = 15V and  $T_A$  = 25°C unless otherwise specified. The  $V_{IN}$ ,  $V_{TH}$  and  $I_{IN}$  parameters are referenced to COM and are applicable to all logic input leads: HIN and LIN. The  $V_O$  and  $I_O$  parameters are referenced to COM and are applicable to the respective output leads: HO or LO.

Symbol	Definition	Min.	Typ.	Max.	Units	Test Conditions
$V_{IH}$	Logic "1" input voltage	2.2	—	—	V	$V_{CC} = 10V - 20V$
$V_{IL}$	Logic "0" input voltage	—	—	0.7		
$V_{OH}$	High level output voltage, $V_{BIAS} - V_O$	—	—	2.0		$I_O = 0A$
$V_{OL}$	Low level output voltage, $V_O$	—	—	0.2		$I_O = 20mA$
$I_{LK}$	Offset supply leakage current	—	—	50	$\mu A$	$V_B = V_S = 200V$
$I_{QBS}$	Quiescent $V_{BS}$ supply current	—	90	210		$V_{IN} = 0V$ or 3.3V
$I_{QCC}$	Quiescent $V_{CC}$ supply current	—	140	230		
$I_{IN+}$	Logic "1" input bias current	—	7.0	20		$V_{IN} = 3.3V$
$I_{IN-}$	Logic "0" input bias current	—	—	1.0		$V_{IN} = 0V$
$V_{BSUV+}$	$V_{BS}$ supply undervoltage positive going threshold	8.2	9.0	9.8	V	
$V_{BSUV-}$	$V_{BS}$ supply undervoltage negative going threshold	7.4	8.2	9.0		
$V_{CCUV+}$	$V_{CC}$ supply undervoltage positive going threshold	8.2	9.0	9.8		
$V_{CCUV-}$	$V_{CC}$ supply undervoltage negative going threshold	7.4	8.2	9.0		
$I_{O+}$	Output high short circuit pulsed current	—	1.0	—	A	$V_O = 0V$ , $PW \leq 10 \mu s$
$I_{O-}$	Output low short circuit pulsed current	—	1.0	—		$V_O = 15V$ $PW \leq 10 \mu s$

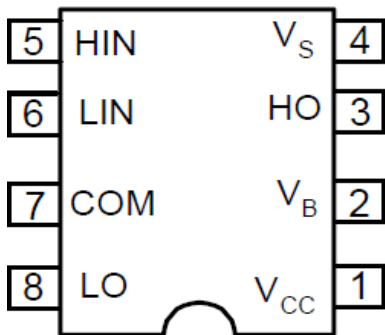
**Functional Block Diagram**



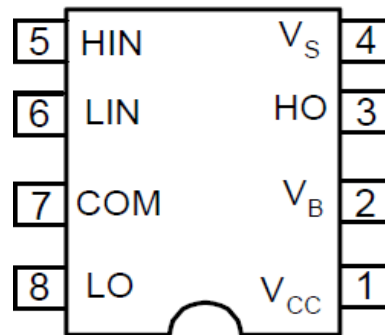
**Lead Definitions**

Symbol	Description
HIN	Logic input for high side gate driver outputs (HO), in phase
LIN	Logic input for low side gate driver outputs (LO), in phase
V <sub>B</sub>	High side floating supply
HO	High side gate drive output
V <sub>S</sub>	High side floating supply return
V <sub>CC</sub>	Low side supply
LO	Low side gate drive output
COM	Low side return

**Lead Assignments**

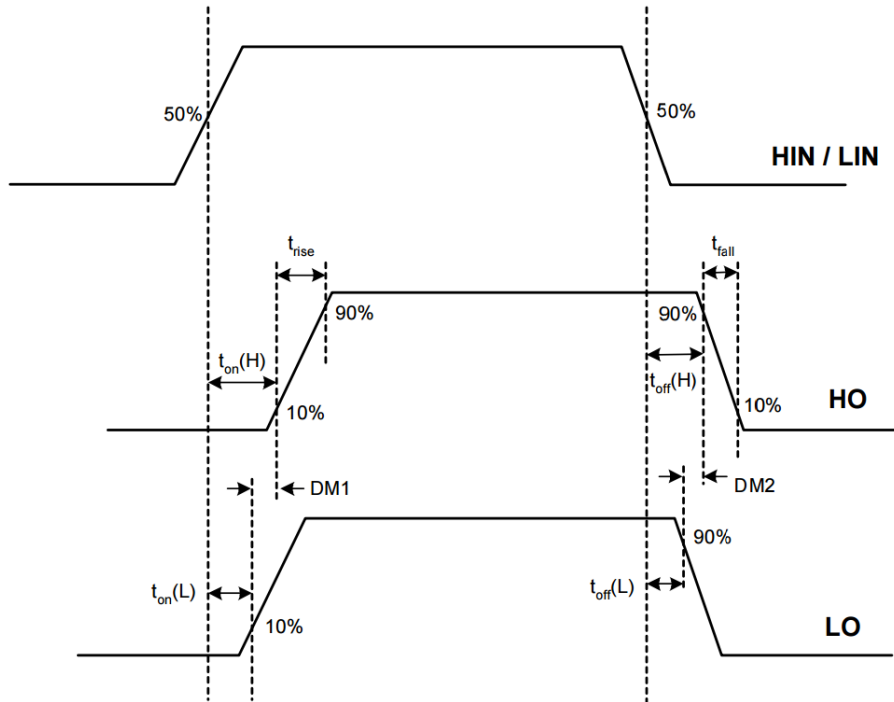


**8-Lead PDIP**

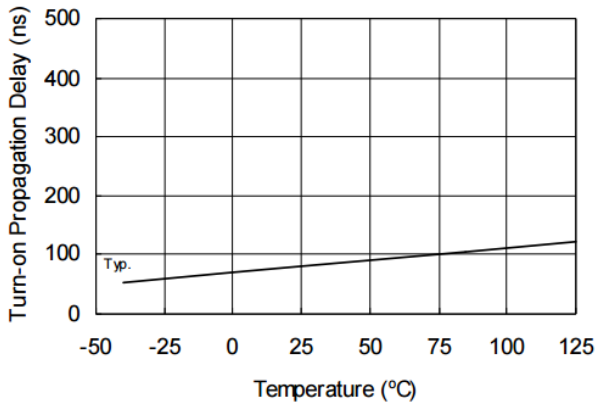


**8-Lead SOIC**

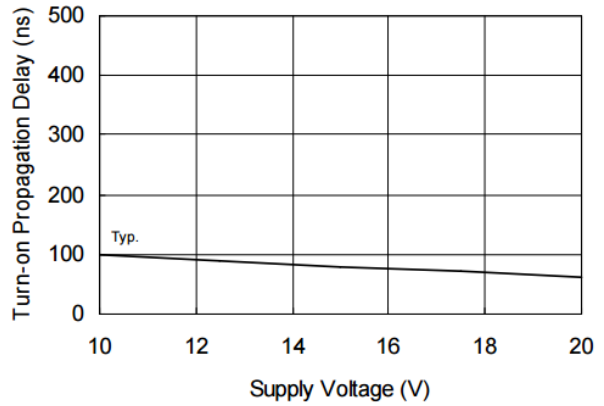
**Application Information and Additional Details**



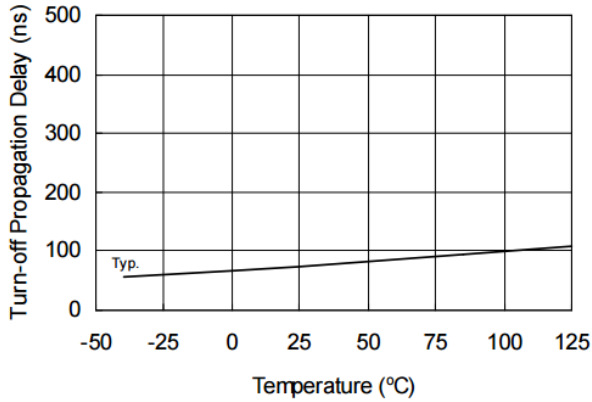
**Figure 1. Timing Diagram**



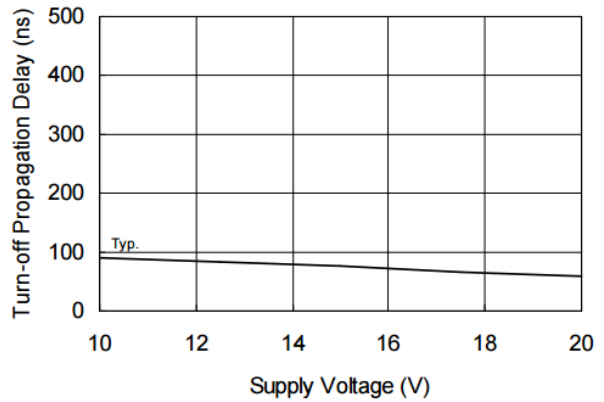
**Figure 2A. Turn-on Propagation Delay vs. Temperature**



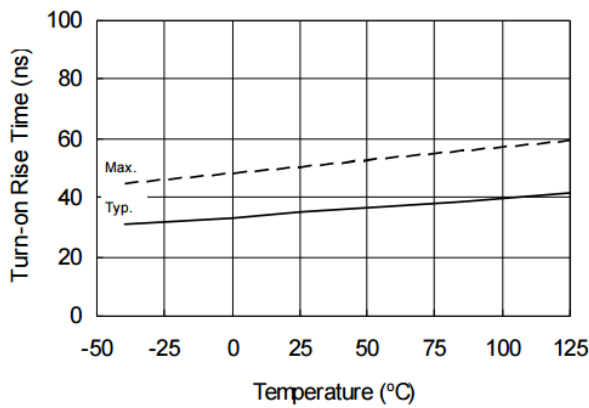
**Figure 2B. Turn-on Propagation Delay vs. Supply Voltage**



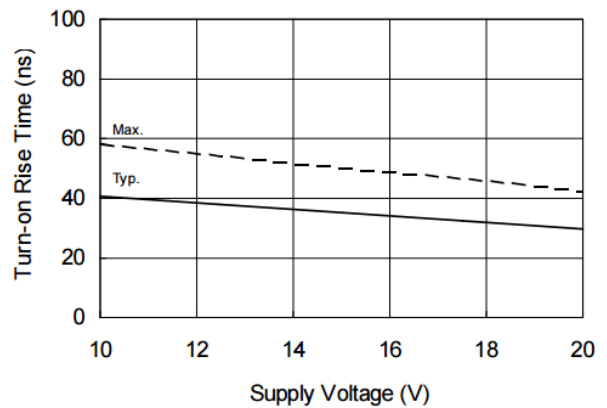
**Figure 3A. Turn-off Propagation Delay vs. Temperature**



**Figure 3B. Turn-off Propagation Delay vs. Supply Voltage**

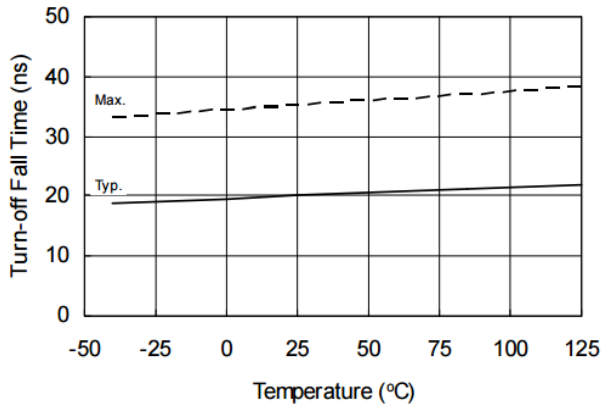


**Figure 4A. Turn-on Rise Time vs. Temperature**

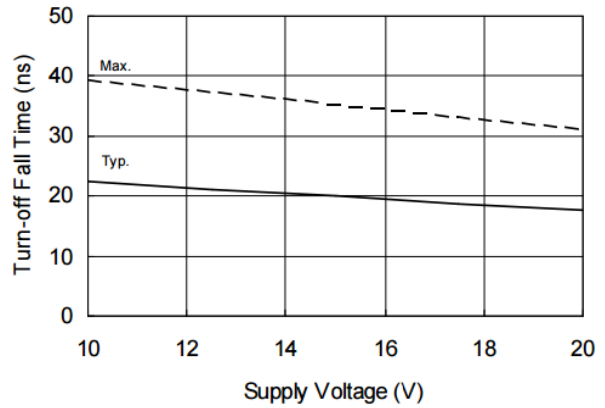


**Figure 4B. Turn-on Rise Time vs. Supply Voltage**

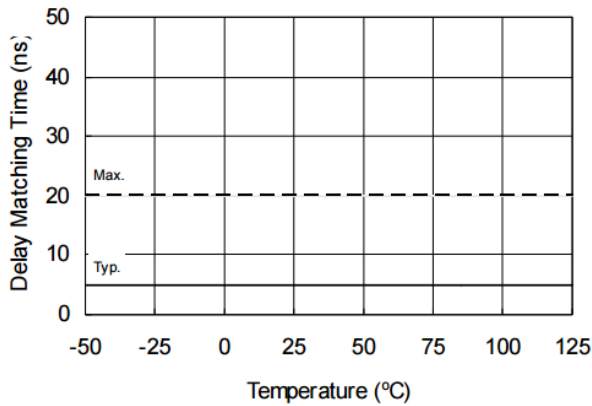




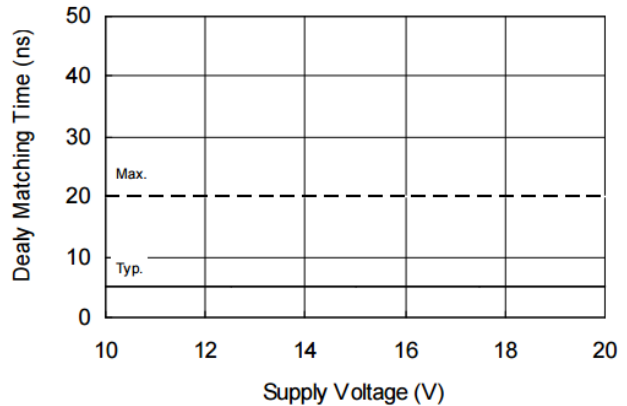
**Figure 5A. Turn-off Fall Time vs. Temperature**



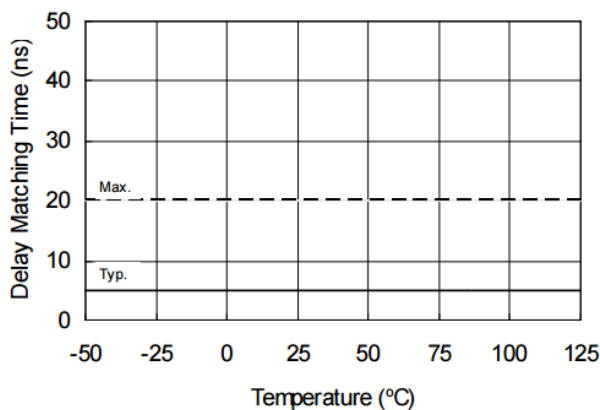
**Figure 5B. Turn-off Fall Time vs. Supply Voltage**



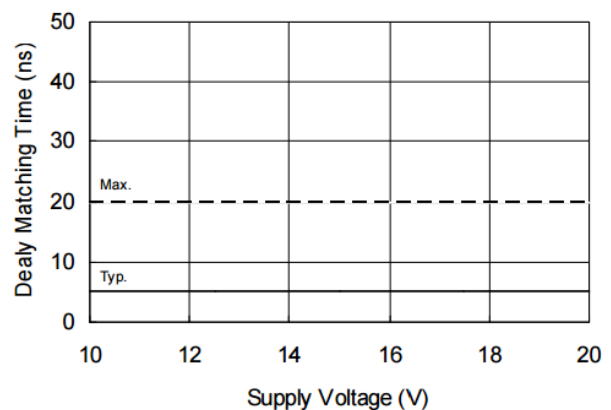
**Figure 6A. Turn-on Delay Matching vs. Temperature**



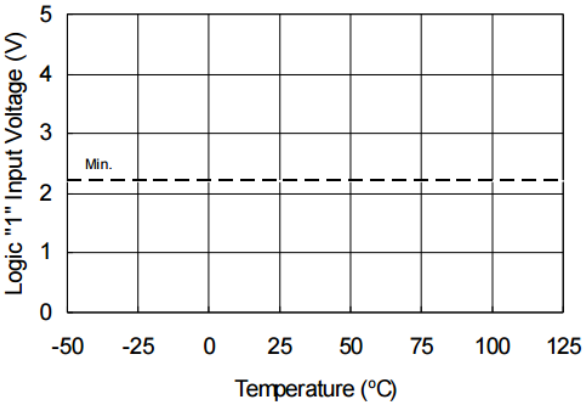
**Figure 6B. Turn-on Delay Matching Time vs. Supply Voltage**



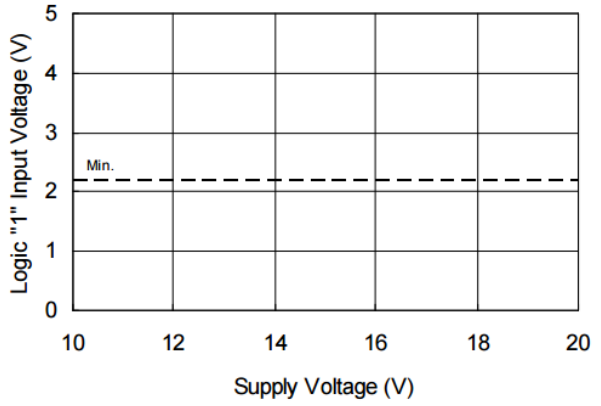
**Figure 7A. Turn-off Delay Matching Time vs. Temperature**



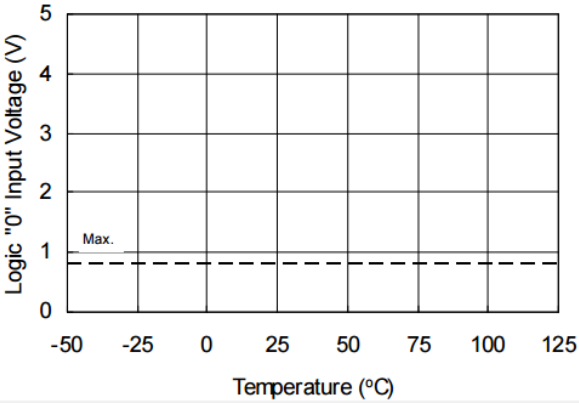
**Figure 7B. Turn-off Delay Matching Time vs. Supply Voltage**



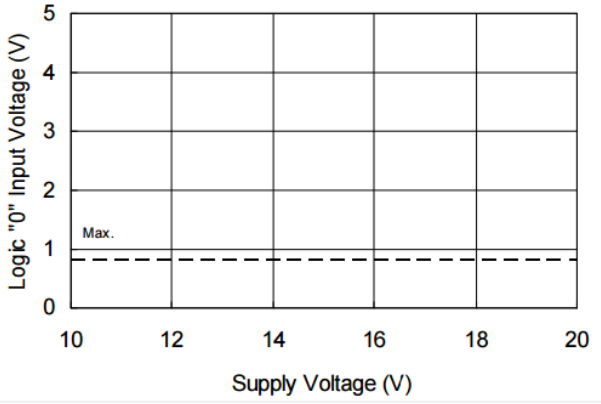
**Figure 8A. Logic "1" Input Voltage vs. Temperature**



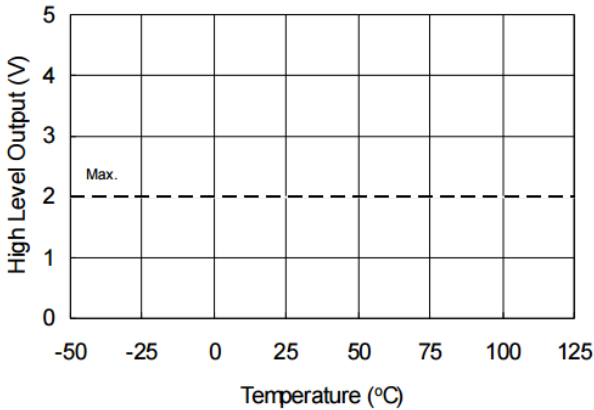
**Figure 8B. Logic "1" Input Voltage vs. Supply Voltage**



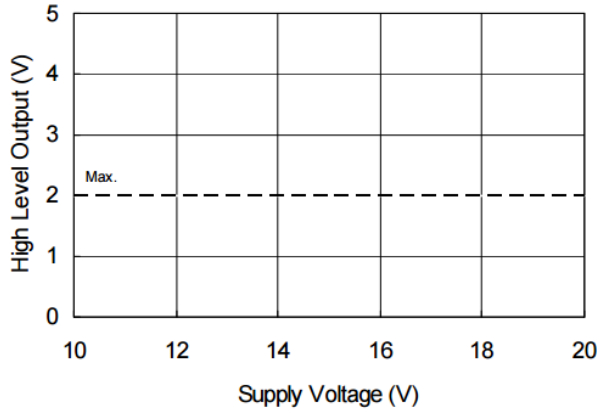
**Figure 9A. Logic "0" Input Voltage vs. Temperature**



**Figure 9B. Logic "0" Input Voltage vs. Supply Voltage**



**Figure 10A. High Level Output vs. Temperature**



**Figure 10B. High Level Output vs. Supply Voltage**

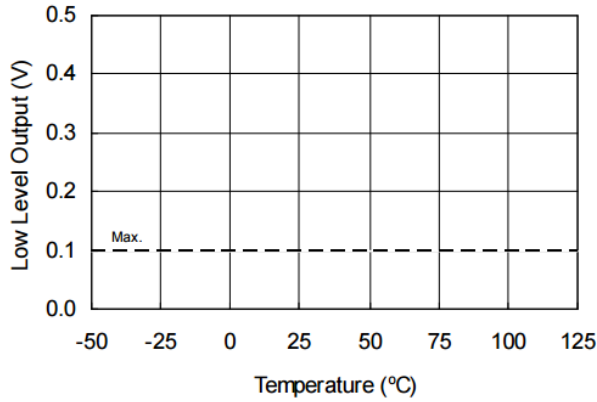


Figure 11A. Low Level Output vs. Temperature

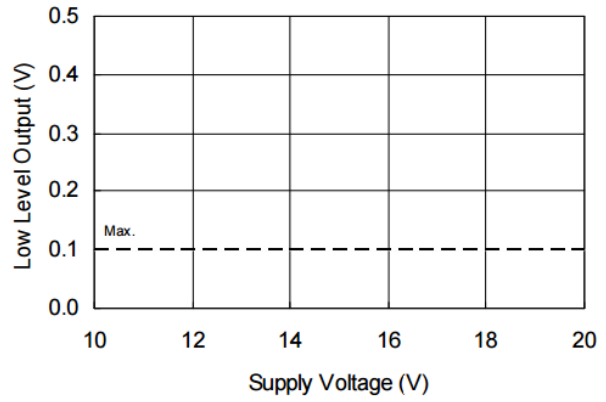


Figure 11B. Low Level Output vs. Supply Voltage

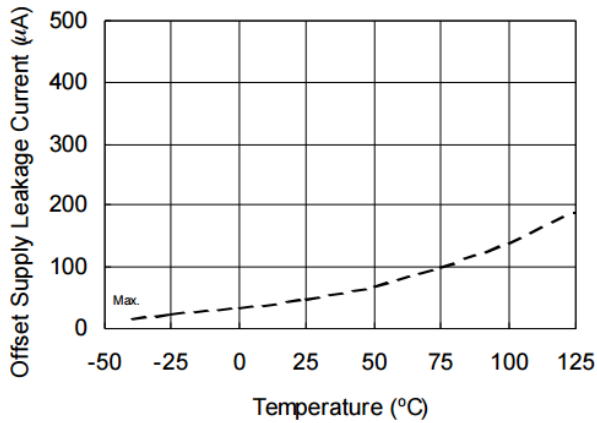


Figure 12A. Offset Supply Leakage Current vs. Temperature

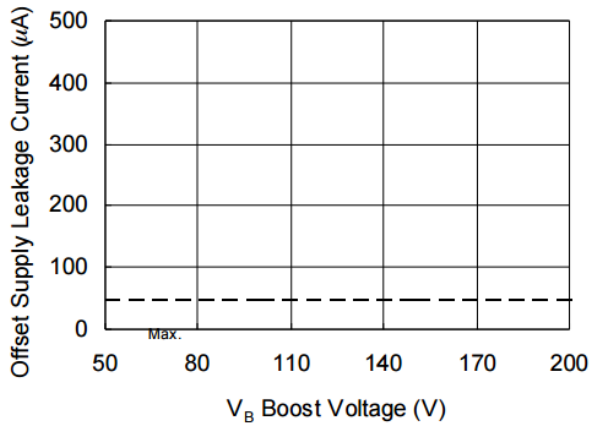


Figure 12B. Offset Supply Leakage Current vs. Supply Voltage

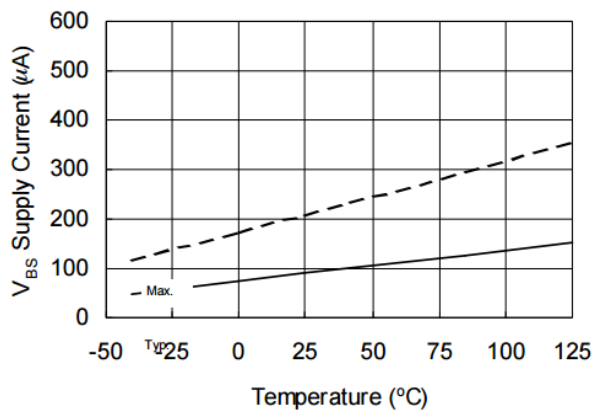


Figure 13A.  $V_{BS}$  Supply Current vs. Temperature

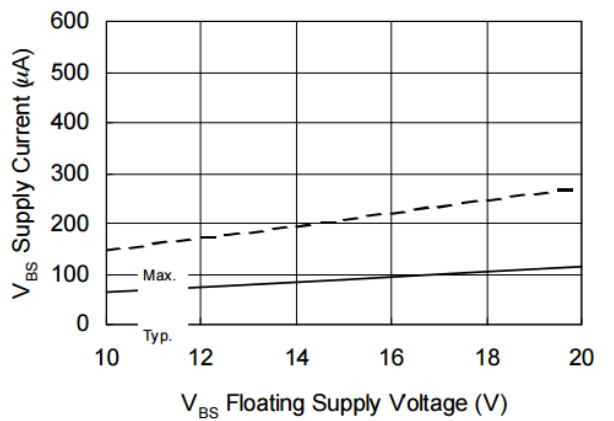


Figure 13B.  $V_{BS}$  Supply Current vs. Supply Voltage

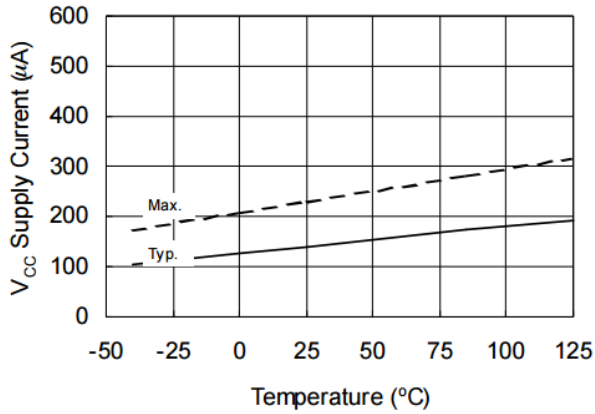


Figure 14A. V<sub>CC</sub> Supply Current vs. Temperature

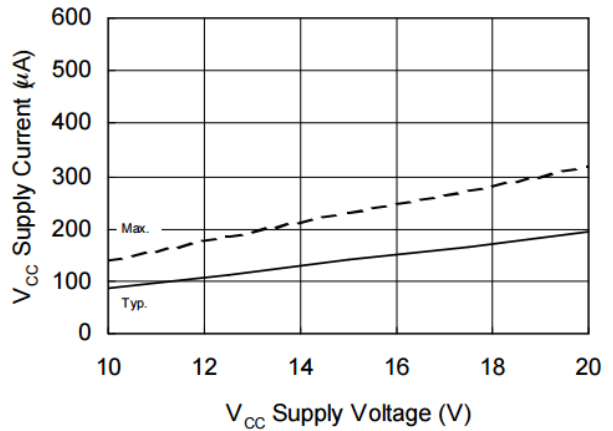


Figure 14B. V<sub>CC</sub> Supply Current vs. V<sub>CC</sub> Supply Voltage

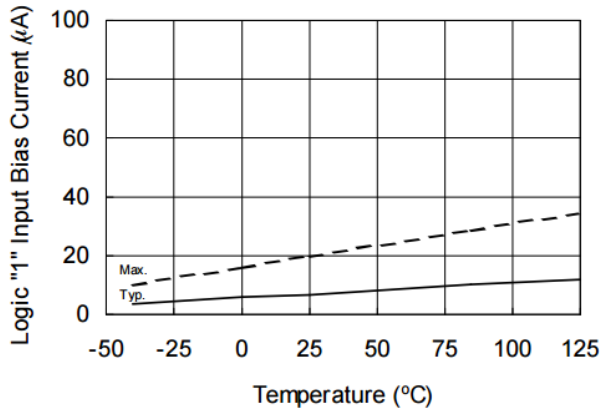


Figure 15A. Logic "1" Input Bias Current vs. Temperature

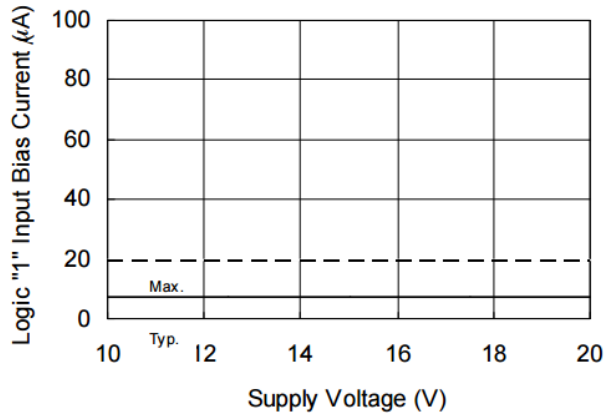


Figure 15B. Logic "1" Input Bias Current vs. Supply Voltage

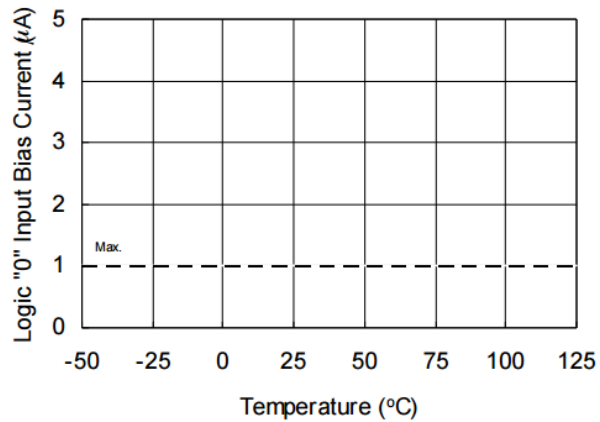


Figure 16A. Logic "0" Input Bias Current vs. Temperature

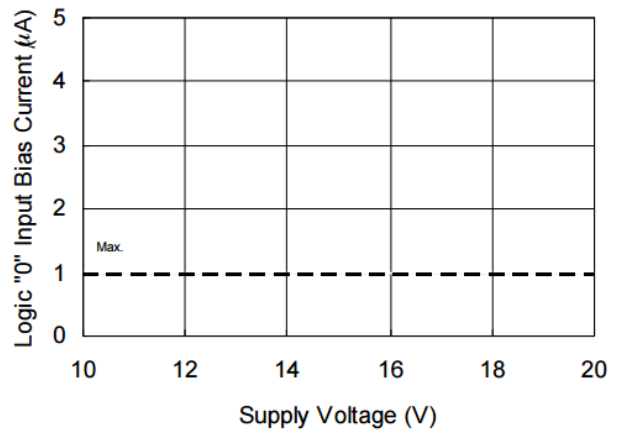
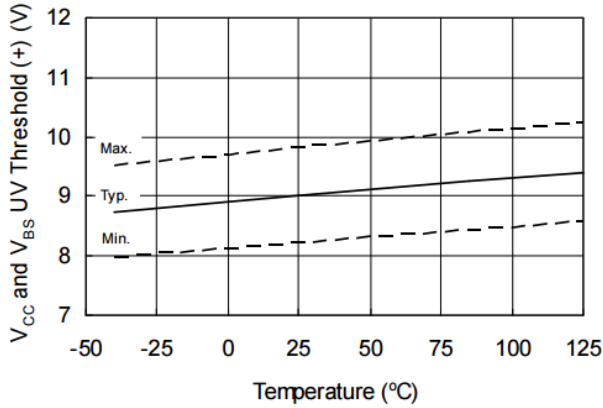
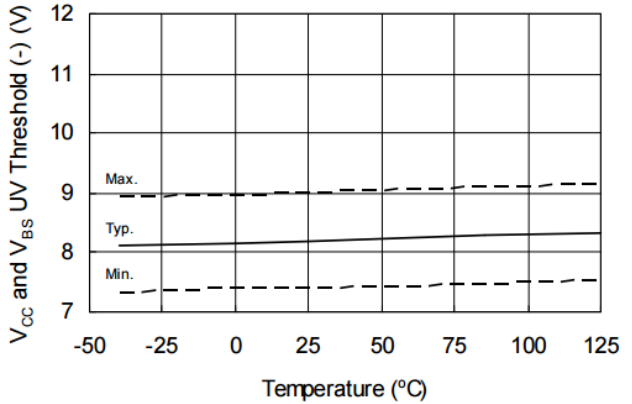


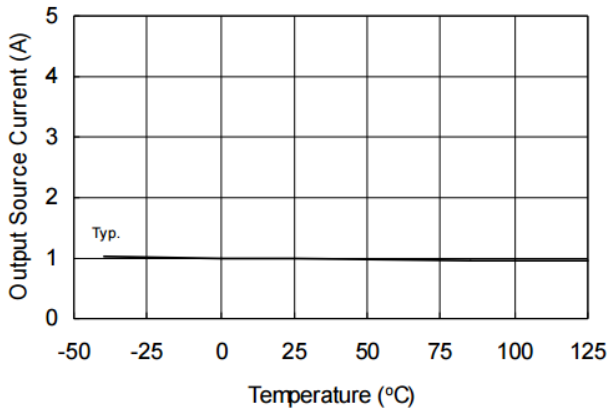
Figure 16B. Logic "0" Input Bias Current vs. Supply Voltage



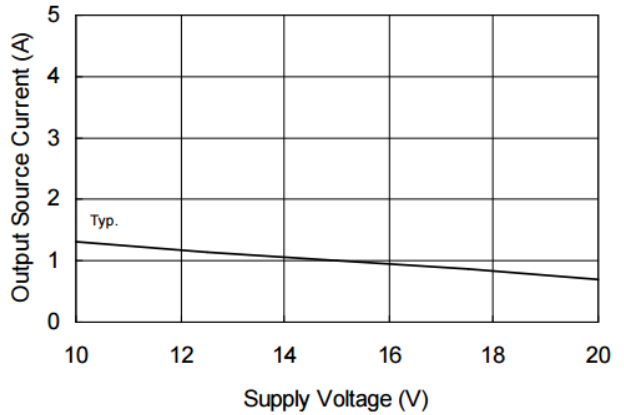
**Figure 17.  $V_{CC}$  and  $V_{BS}$  Undervoltage Threshold (+) vs. Temperature**



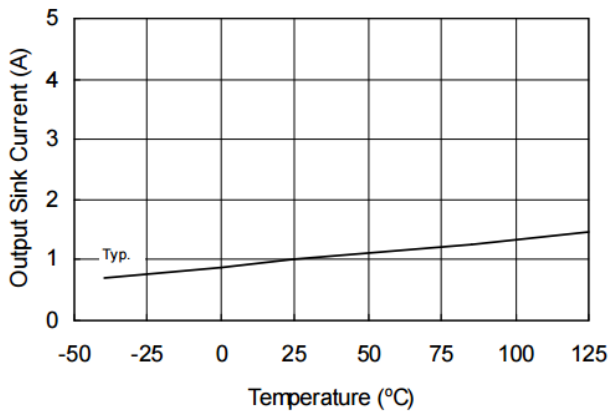
**Figure 18.  $V_{CC}$  and  $V_{BS}$  Undervoltage Threshold (-) vs. Temperature**



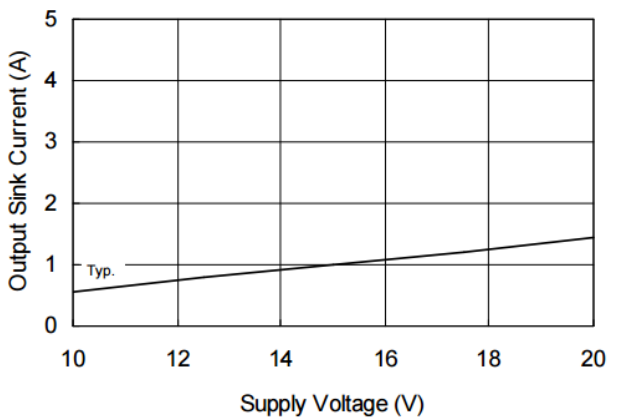
**Figure 19A. Output Source Current vs. Temperature**



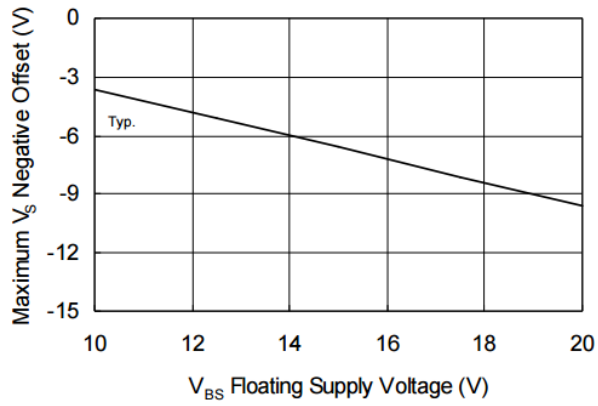
**Figure 19B. Output Source Current vs. Supply Voltage**



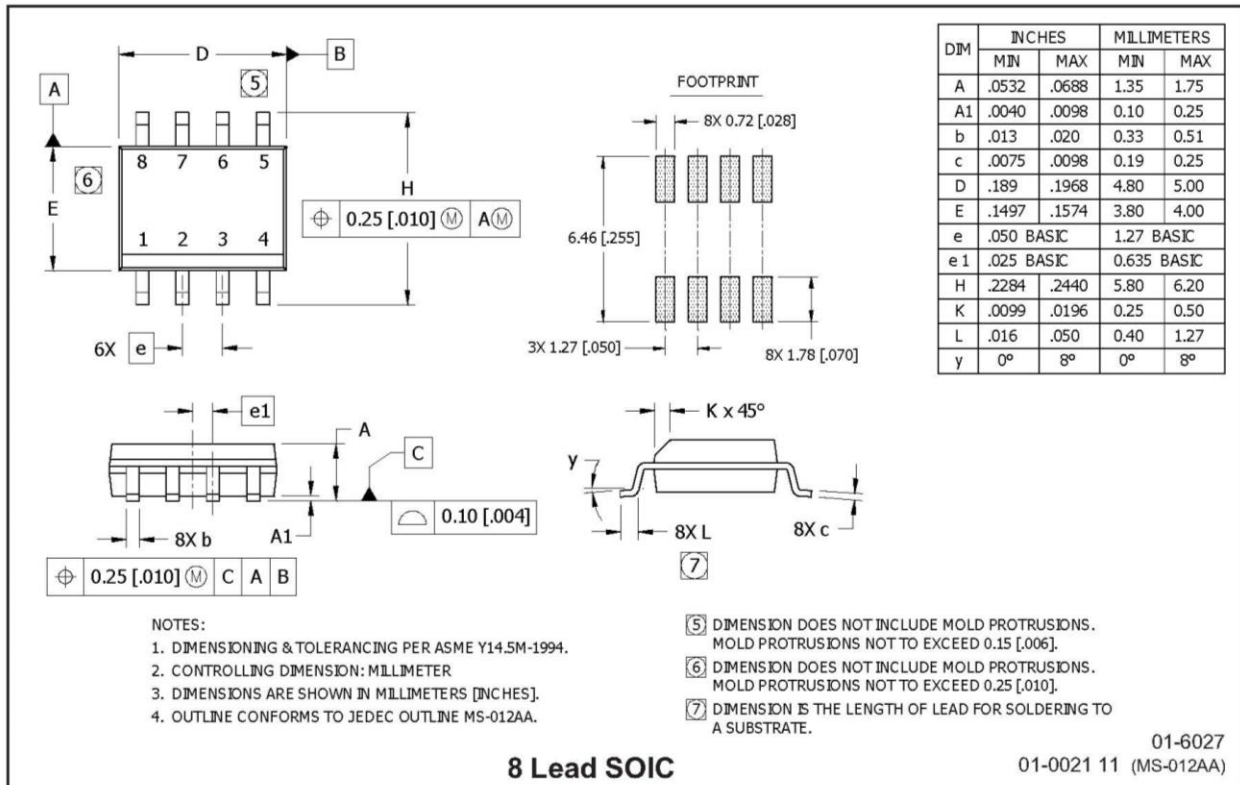
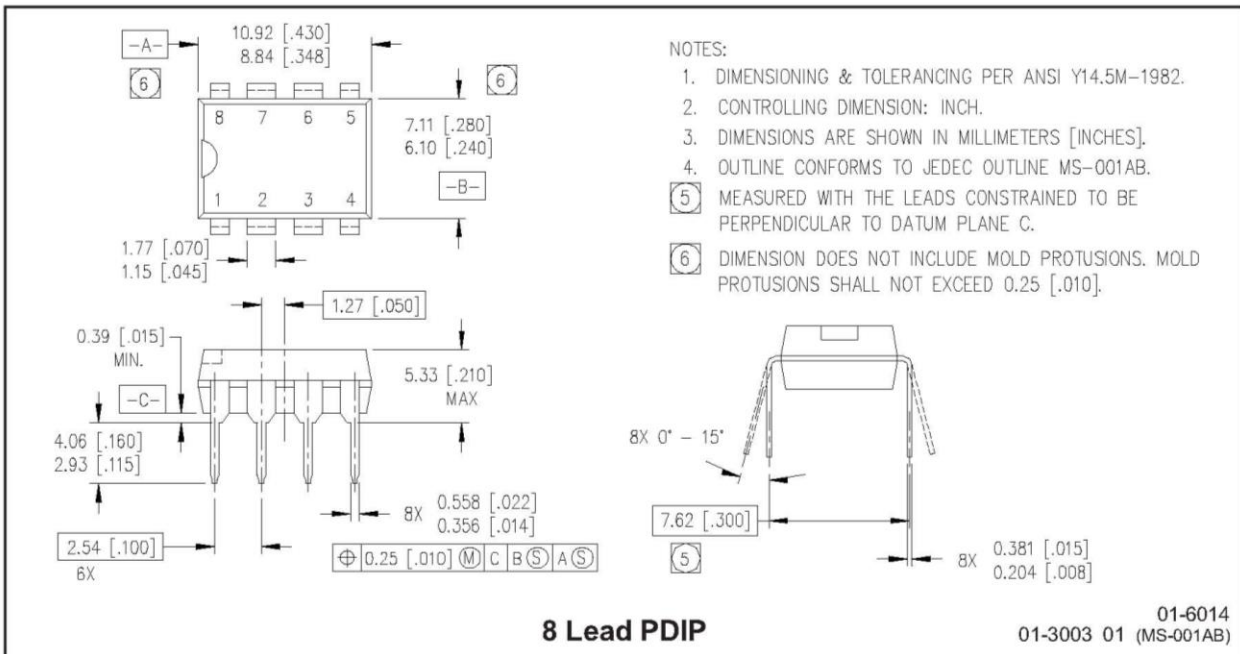
**Figure 20A. Output Sink Current vs. Temperature**



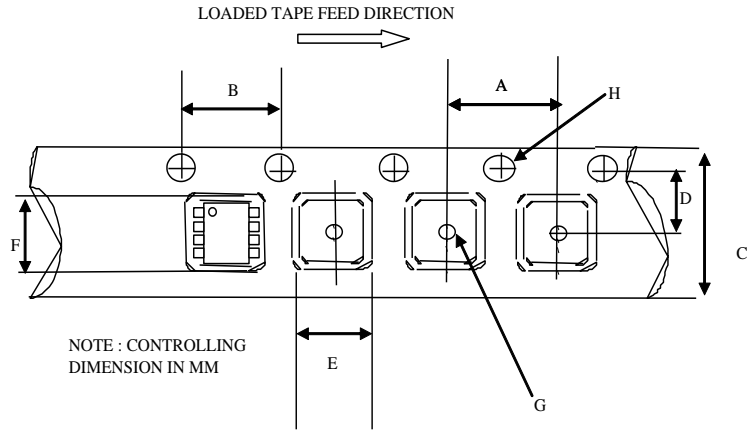
**Figure 20B. Output Sink Current vs. Supply Voltage**



**Figure 21. Maximum V<sub>S</sub> Negative Offset vs. V<sub>BS</sub> Floating Supply Voltage**

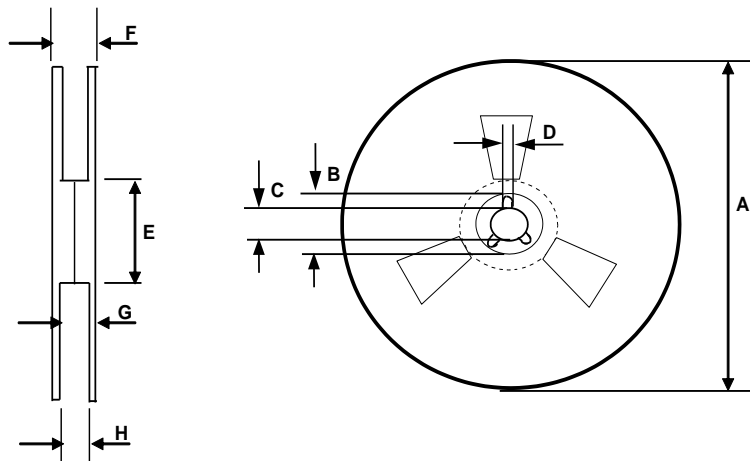
**Package Details**


## Tape and Reel Details



CARRIER TAPE DIMENSION FOR 8SOICN

Code	Metric		Imperial	
	Min	Max	Min	Max
A	7.90	8.10	0.311	0.318
B	3.90	4.10	0.153	0.161
C	11.70	12.30	0.46	0.484
D	5.45	5.55	0.214	0.218
E	6.30	6.50	0.248	0.255
F	5.10	5.30	0.200	0.208
G	1.50	n/a	0.059	n/a
H	1.50	1.60	0.059	0.062

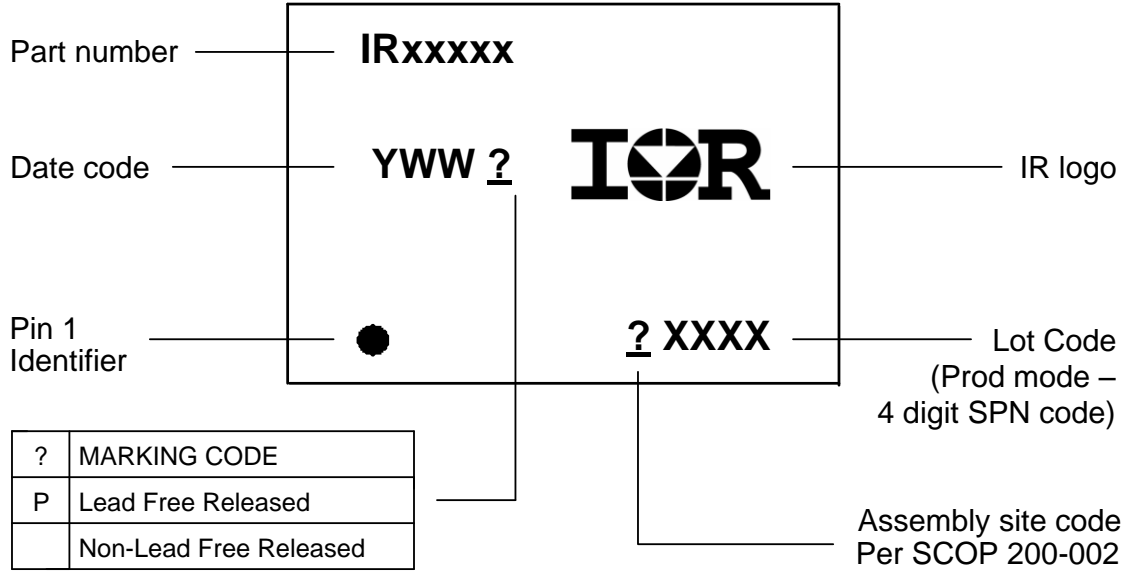


REEL DIMENSIONS FOR 8SOICN

Code	Metric		Imperial	
	Min	Max	Min	Max
A	329.60	330.25	12.976	13.001
B	20.95	21.45	0.824	0.844
C	12.80	13.20	0.503	0.519
D	1.95	2.45	0.767	0.096
E	98.00	102.00	3.858	4.015
F	n/a	18.40	n/a	0.724
G	14.50	17.10	0.570	0.673
H	12.40	14.40	0.488	0.566



**Part Marking Information**



**Qualification Information<sup>†</sup>**

<b>Qualification Level</b>		Industrial <sup>††</sup> (per JEDEC JESD 47)
		Comments: This family of ICs has passed JEDEC's Industrial qualification. IR's Consumer qualification level is granted by extension of the higher Industrial level.
<b>Moisture Sensitivity Level</b>	8-Lead SOIC	MSL2 <sup>†††</sup> (per IPC/JEDEC J-STD-020)
<b>RoHS Compliant</b>		Yes

† Qualification standards can be found at International Rectifier's web site <http://www.irf.com/>

†† Higher qualification ratings may be available should the user have such requirements. Please contact your International Rectifier sales representative for further information.

††† Higher MSL ratings may be available for the specific package types listed here. Please contact your International Rectifier sales representative for further information.

The information provided in this document is believed to be accurate and reliable. However, International Rectifier assumes no responsibility for the consequences of the use of this information. International Rectifier assumes no responsibility for any infringement of patents or of other rights of third parties which may result from the use of this information. No license is granted by implication or otherwise under any patent or patent rights of International Rectifier. The specifications mentioned in this document are subject to change without notice. This document supersedes and replaces all information previously supplied.

For technical support, please contact IR's Technical Assistance Center  
<http://www.irf.com/technical-info/>

**WORLD HEADQUARTERS:**  
 233 Kansas St., El Segundo, California 90245  
 Tel: (310) 252-7105