

TMR 2 Series

Application Note

DC/DC Converter 4.5 to 9Vdc, 9 to 18Vdc, 18 to 36Vdc or 36 to 75 Vdc Input
3.3 to 15Vdc Single Outputs and ± 5 to ± 15 Vdc Dual Outputs, 2 Watt

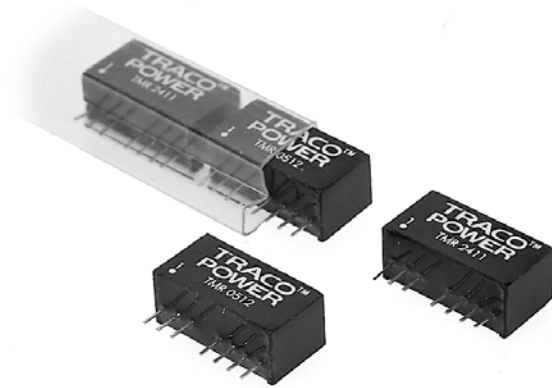

E188913

Complete TMR-2 datasheet can be downloaded at:

<http://www.tracopower.com/products/tmr.pdf>

Features

- SIP package: 21.8 x 9.2 x 11.1 mm (0.86 x 0.36 x 0.44inch)
- 2 : 1 wide input voltage of 4.5-9, 9-18, 18-36 and 36-75VDC
- 2 Watts output power
- Low ripple & noise
- UL94-V0 case potting materials
- Input to output isolation: 1000Vdc, for 1 minute
- Operating temperature range: up to 75°C max without derating
- Continuous short circuit protection
- RoHS directive compliant
- External on/off control
- ISO 9001 certified manufacturing facilities
- UL60950-1 Recognized E188913

Applications

- test equipment
- Communication equipment
- Computer equipment
- mobile telecom equipment

General Description

The TMR 2 series offer 2 watts of output power from a 21.8 x 9.2 x 11.1 mm package up to an operating temperature of +75°C without derating and without need of any external components. This product has a 2:1 wide input voltage range of 4.5-9Vdc, 9-18Vdc, 18-36Vdc or 36-75Vdc and features an input to output isolation of 1000Vdc, indefinite short-circuit protection. All models are particularly suited to telecommunications, industrial, mobile telecom and test equipment applications.

Table of contents

Block Diagram	P2	EMC consideration	P8
Absolute maximum rating	P2	Input Source Impedance	P8
Output Specifications	P2 & P3	Characteristic curve	P9 - P20
Input Specifications	P3 & P4	Thermal Consideration	P21
General Specifications	P5	Part number structure	P21
Remote on/off control	P6	EMC Specifications	P21 & P22
Output over current protection	P6	Mechanical data	P22
Short circuitry protection	P6	Safety and installation instruction	P23
Solder, clearing, and drying considerations	P7	MTBF and Reliability	P23
Test configurations	P7 & P8		

Block Diagram

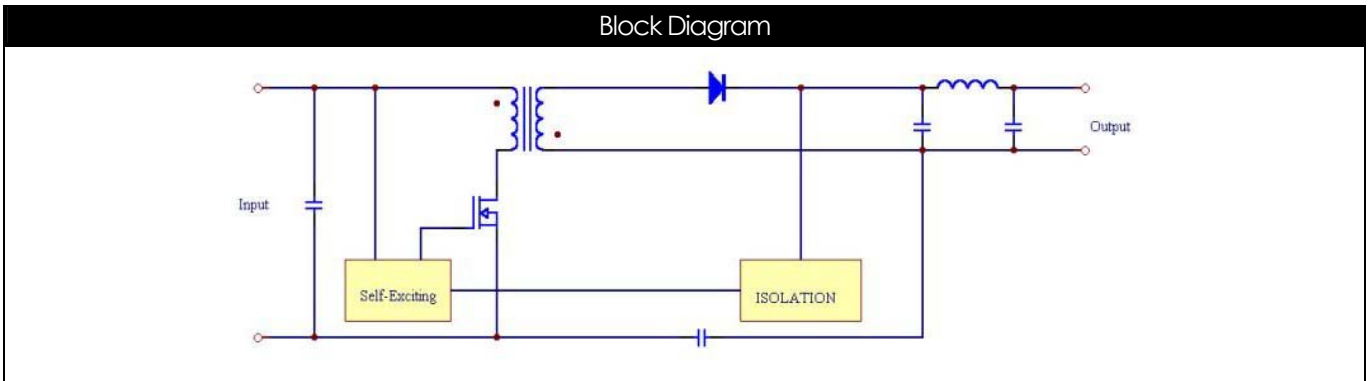

Absolute Maximum Rating

Parameter		Device	Min	Typ	Max	Unit
Input Voltage	Continuous	TMR 05xx			9	Vdc
		TMR 12xx			18	Vdc
		TMR 24xx			36	Vdc
		TMR 48xx			75	Vdc
	Transient (100ms)	TMR 05xx			15	Vdc
		TMR 12xx			36	Vdc
		TMR 24xx			50	Vdc
		TMR 48xx			100	Vdc
Output power					2	W
Temperature coefficient					±0.1	%/°C

Output Specifications

Parameter	Device	Min	Typ	Max	Unit
Operating Output Range	TMR xx10	3.267	3.300	3.333	Vdc
	TMR xx11	4.950	5.000	5.050	Vdc
	TMR xx09	8.910	9.000	9.090	Vdc
	TMR xx12	11.880	12.000	12.120	Vdc
	TMR xx13	14.850	15.000	15.150	Vdc
	TMR xx21	±4.950	±5.000	±5.050	Vdc
	TMR xx22	±11.880	±12.000	±12.120	Vdc
	TMR xx23	±14.850	±15.000	±15.150	Vdc
Output Current	TMR xx10	50		500	mA
	TMR xx11	40		400	mA
	TMR xx09	22		222	mA
	TMR xx12	17		167	mA
	TMR xx13	13		134	mA
	TMR xx21	±20		±200	mA
	TMR xx22	±8		±83	mA
	TMR xx23	±7		±67	mA
Max. Output Capacitive Load	TMR xx10			2200	µF
	TMR xx11			1000	µF
	TMR xx09			470	µF
	TMR xx12			170	µF
	TMR xx13			110	µF
	TMR xx21			±470	µF
	TMR xx22			±100	µF
	TMR xx23			±47	µF

Output Specifications (continue)					
Parameter	Device	Min	Typ	Max	Unit
Line Regulation (LL to HL at Full Load)	All			0.5	%
Load Regulation (10% to 100% of Full Load)	TMR xx10			±0.85	%
	Other single output			±0.75	
	Dual output			±1.00	
Cross regulation (Asymmetrical load 25% to 100% of Full Load)				±5.0	
Output Ripple & Noise (20MHz bandwidth)	All			50	mV pk-pk
Transient Response Recovery Time (25% load step change)	All		500		µS

Input Specifications						
Parameter		Device	Min	Typ	Max	Unit
Input Voltage	Continuous	TMR 05xx	4.5	5.0	9	Vdc
		TMR 12xx	9	12.0	18	Vdc
		TMR 24xx	18	24.0	36	Vdc
		TMR 48xx	36	48.0	75	Vdc
Input Current (Maximum Value at $V_{in} = V_{in, nom}$; Full Load)		TMR 0510			540	mA
		TMR 0511			615	mA
		TMR 0509			596	mA
		TMR 0512			588	mA
		TMR 0513			582	mA
		TMR 0521			645	mA
		TMR 0522			595	mA
		TMR 0523			598	mA
		TMR 1210			202	mA
		TMR 1211			234	mA
		TMR 1209			222	mA
		TMR 1212			219	mA
		TMR 1213			220	mA
		TMR 1221			242	mA
		TMR 1222			224	mA
		TMR 1223			226	mA
		TMR 2410			102	mA
		TMR 2411			115	mA
		TMR 2409			109	mA
		TMR 2412			109	mA
		TMR 2413			108	mA
		TMR 2421			117	mA
		TMR 2422			112	mA
		TMR 2423			110	mA
		TMR 4810			52	mA
		TMR 4811			60	mA
		TMR 4809			56	mA
	TMR 4812			55	mA	
	TMR 4813			55	mA	
	TMR 4821			62	mA	
	TMR 4822			57	mA	
	TMR 4823			57	mA	

Input Specifications (continue)						
Parameter	Device	Min	Typ	Max	Unit	
Input Standby Current (Typical Value at $V_{in} = V_{in,nom}$; No Load)	TMR 0510		60		mA	
	TMR 0511		55		mA	
	TMR 0509		55		mA	
	TMR 0512		75		mA	
	TMR 0513		40		mA	
	TMR 0521		75		mA	
	TMR 0522		75		mA	
	TMR 0523		90		mA	
	TMR 1210		20		mA	
	TMR 1211		25		mA	
	TMR 1209		25		mA	
	TMR 1212		30		mA	
	TMR 1213		30		mA	
	TMR 1221		50		mA	
	TMR 1222		40		mA	
	TMR 1223		40		mA	
	TMR 2410		10		mA	
	TMR 2411		10		mA	
	TMR 2409		15		mA	
	TMR 2412		15		mA	
	TMR 2413		15		mA	
	TMR 2421		15		mA	
	TMR 2422		20		mA	
	TMR 2423		20		mA	
	TMR 4810		10		mA	
	TMR 4811		10		mA	
	TMR 4809		10		mA	
	TMR 4812		10		mA	
	TMR 4813		10		mA	
	TMR 4821		10		mA	
TMR 4822		10		mA		
TMR 4823		12		mA		
Input reflected ripple current (It will not damage the device if the capacitor on the input is not equipped)	5V input (100 μ F)			400	mA pk-pk	
	12V input (100 μ F)			150	mA pk-pk	
	24V input (10 μ F)			380	mA pk-pk	
	48V input (10 μ F)			170	mA pk-pk	
Start up time (nominal V_{in} and constant resistive load power up)	Power up		1		mS	
	Remote ON/OFF		1		mS	
Remote ON/OFF Control (See Page 13)						
DC-DC ON	All		Open		mA	
DC-DC OFF		4		8		
Remote Off Input Current	All			2.5	mA	

General Specifications					
Parameter	Device	Min	Typ	Max	Unit
Efficiency at $V_{in,nom}$ and full load (Please see the testing configurations part)	TMR 0510		65		%
	TMR 0511		69		%
	TMR 0509		71		%
	TMR 0512		72		%
	TMR 0513		73		%
	TMR 0521		66		%
	TMR 0522		71		%
	TMR 0523		71		%
	TMR 1210		72		%
	TMR 1211		75		%
	TMR 1209		79		%
	TMR 1212		80		%
	TMR 1213		80		%
	TMR 1221		73		%
	TMR 1222		78		%
	TMR 1223		78		%
	TMR 2410		71		%
	TMR 2411		76		%
	TMR 2409		80		%
	TMR 2412		80		%
	TMR 2413		81		%
	TMR 2421		75		%
	TMR 2422		78		%
	TMR 2423		80		%
	TMR 4810		70		%
	TMR 4811		74		%
	TMR 4809		78		%
	TMR 4812		80		%
	TMR 4813		79		%
	TMR 4821		75		%
TMR 4822		77		%	
TMR 4823		77		%	
Isolation resistance	All	10^9			Ω
Isolation Capacitance	All		300	1000	pF
Switching Frequency (full load to minimum load)	All	100		650	KHz
Weight	All		4.8		g
MTBF (please see the MTBF and reliability part)	All		5.107×10^6		hours

Remote On/Off Control

Only one type of remote on/off control is available for TMR. The module will turn on during the ctrl pin left open or high impedance between ctrl pin and -Vin pin. The module will turn off if the control pin is applied with a current of 4~8mA.

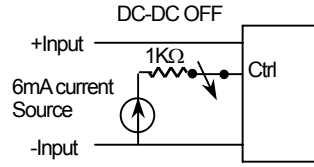
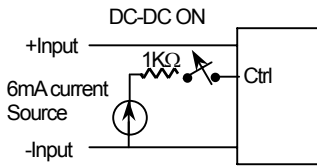

In off condition the input current is app. 1mA max.

Positive Logic:

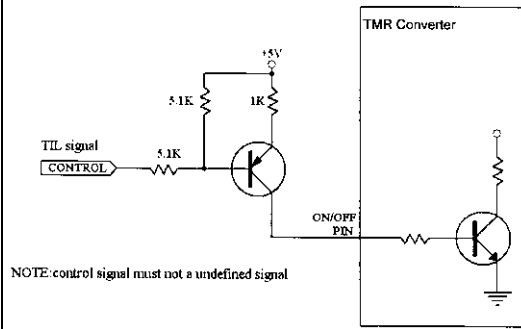

Negative Logic:

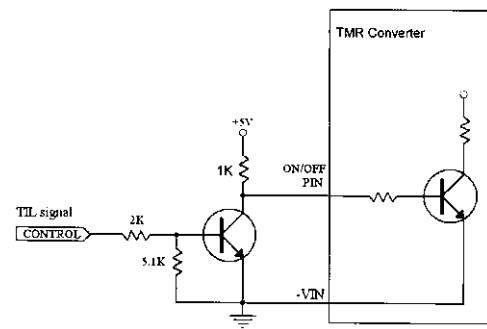

Output over current protection

When excessive output currents occur in the system, circuit protection is required on all converters. Normally, overload current is maintained at approximately 115~175% percent of rated current.

The TMR converters have a fold-back over current protection. Fold back current protection reduces the load current during over current condition. The figure below shows a typical curve. Since the over current protection is a fold-back characteristic the highest power dissipation occurs at point S. During start-up this product provides less output current, hence the output rises slower, or the power supply may not start up at all if the load current during start up is larger than the fold back current.

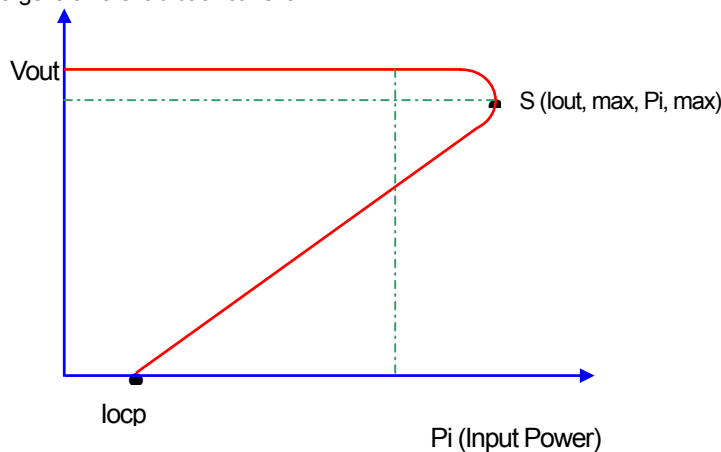

Short Circuitry Protection

Continuous, hiccup and auto-recovery mode. During short circuit, converter will shut down and will switch on again to detect if the short circuit is still present or not. The average current during this condition will be very low and the device will be safe in short circuit condition. Due to that is the TMR converters indefinite short circuit protected.

Solder, clearing, and drying considerations

Soldering

Flow (wave) soldering: 250°C ±10°C less than 10 seconds (see below)
 Soldering iron: 370°C ±10°C less than 5 seconds

Note: the pin of this product is Tin coated. To assure the solder-ability, modules should be kept in their original shipping containers to provide adequate protection. Also, the storage environment shall be well controlled to protect any oxidation.

Cleaning process

In aqueous cleaning, it is preferred to have an in-line cleaner system consisting of several cleaning stages (pre-wash, wash, rinse, final rinse, and drying). Deionize (DI) water is recommended for aqueous cleaning; the minimum resistive level is 1MΩ-cm.

Tap-water quality varies per region in terms of hardness, chloride, and solid contents; therefore, the use of tap water is not recommended for aqueous cleaning.

Drying

The drying section of the cleaner system should be equipped with blowers capable of generating 1000cfm -1500cfm of air so that the amount of rinse water left to be dried off with heat is minimal. Handheld air guns are not recommended due to the variability and consistency of the operation.

Note: after post-wash, the marking (date code) of converter may fall off. This only impacts the appearance and does not affect the operation of the module.

Testing Configurations

Input reflected-ripple current measurement test up

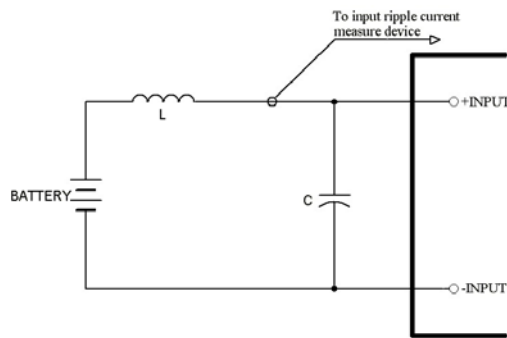

TMR 05xx and TMR 12xx

Component	Value	Voltage	Reference
C	100µF	50V	Aluminium Electrolytic Capacitor

TMR 24xx and TMR 48xx

Component	Value	Voltage	Reference
C	10µF	100V	Aluminium Electrolytic Capacitor

Peak-to-peak output ripple & noise measurement test up

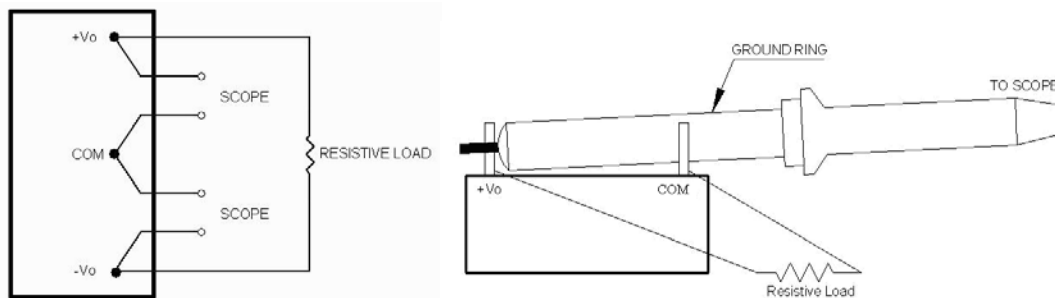

Testing Configurations (continue)

Output voltage and efficiency measurement test up

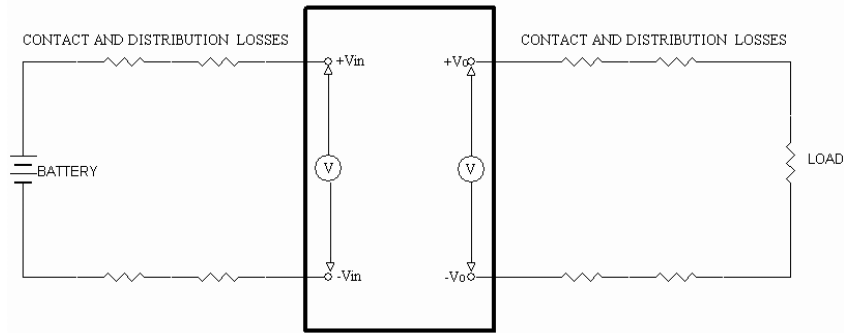

Note: All measurements are taken at the module terminals.

$$Efficiency = \left(\frac{V_o \times I_o}{V_{in} \times I_{in}} \right) \times 100\%$$

EMC considerations

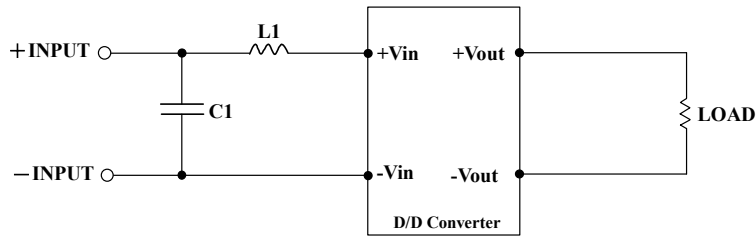

Suggested Schematic for EN55022 Conducted Emission Class B Limits

To comply with EN55022 CLASS B conducted emissions the following components are recommended:

TMR 05xx and TMR 12xx

Component	Value	Voltage	Reference
C1	22 μ F	25V	1812 MLCC Capacitor
L1	3.3 μ H	2.0A / 0.06 Ω / 0504	SMD Inductor, P/N: TCK-044

TMR 24xx

Component	Value	Voltage	Reference
C1	4.7 μ F	50V	1812 MLCC Capacitor
L1	12 μ H	1.4A / 0.12 Ω / 0504	SMD Inductor, P/N: TCK-062

TMR 48xx

Component	Value	Voltage	Reference
C1	2.2 μ F	100V	1812 MLCC Capacitor
L1	27 μ H	0.9A / 0.2 Ω / 0504	SMD Inductor, P/N: TCK-063

Input Source Impedance

The power module should be connected to a low impedance input source. Highly inductive source impedance can affect the stability of the power module. Input external L-C filter is recommended to minimize input reflected ripple current. The capacitor should be equipped as close as possible to the input terminals of the power module for lower impedance.

Characteristic Curve

Efficiency

a. Efficiency with load change under different line condition at room temperature

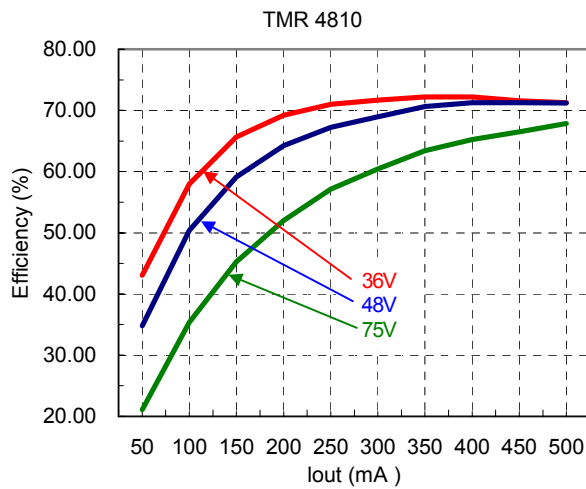
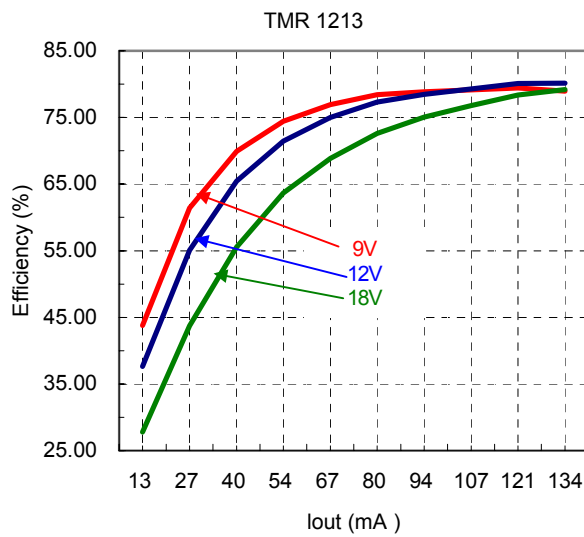
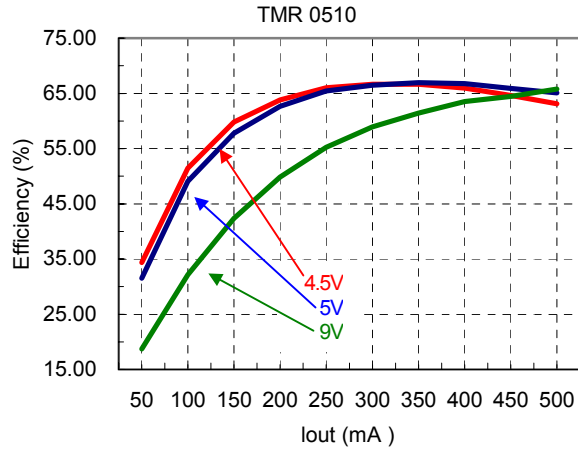

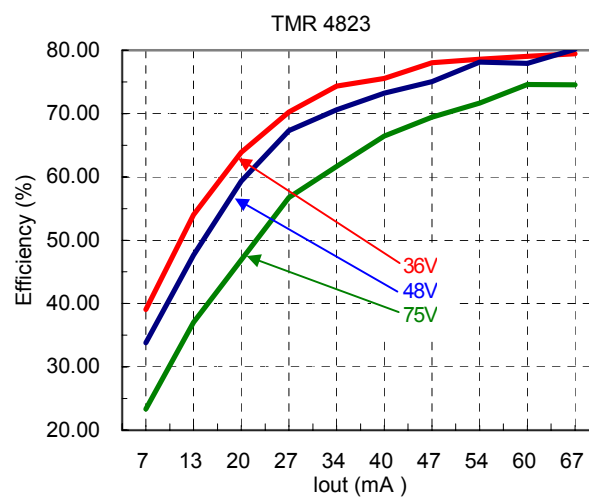
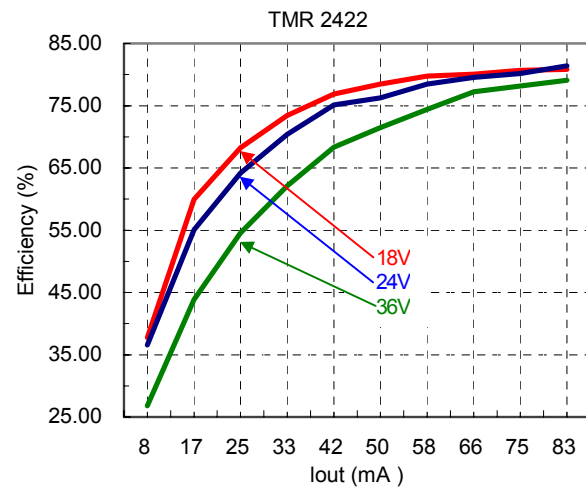
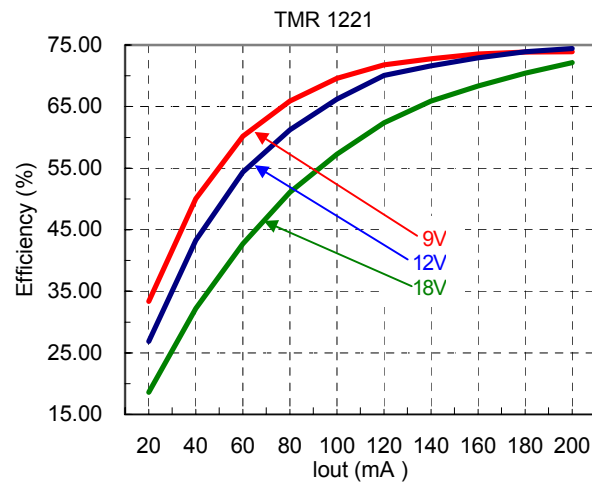

b. Efficiency at input voltage change under different load condition at room temperature

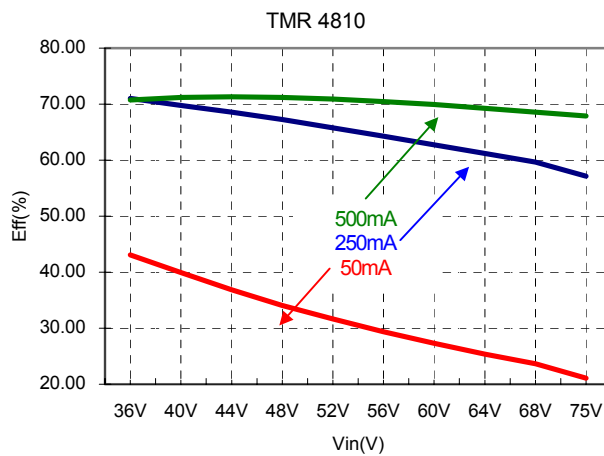
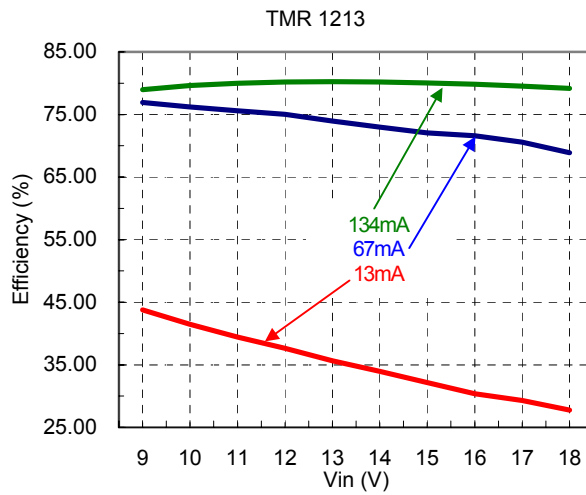
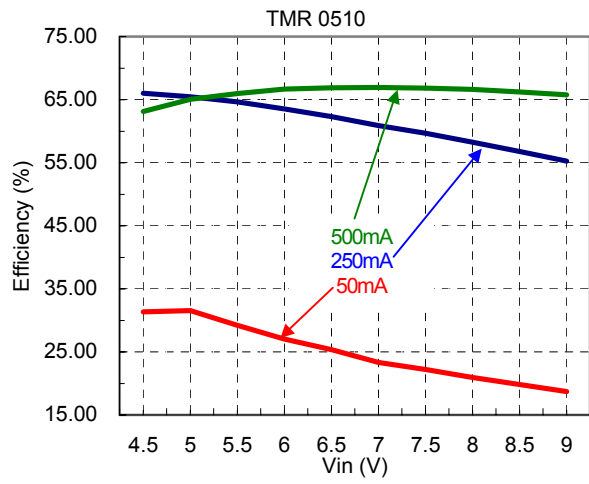

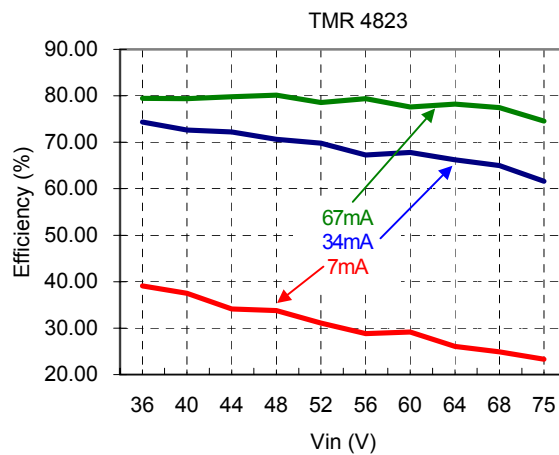
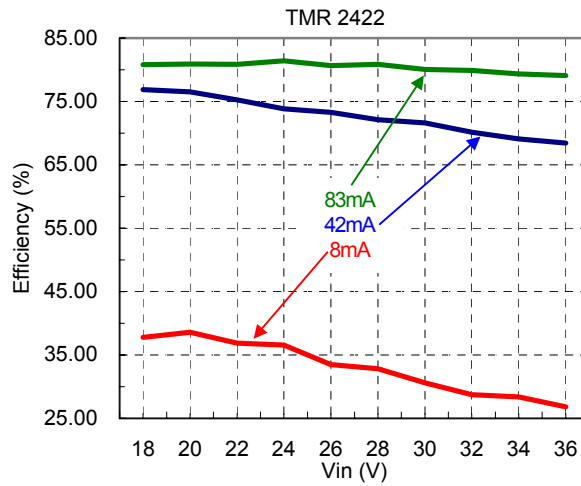
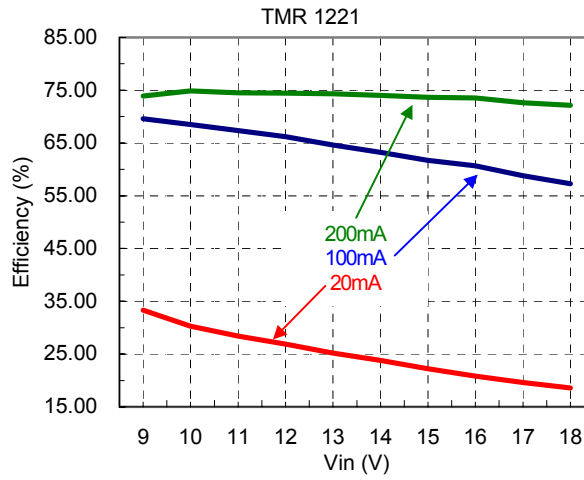

Power dissipation curve

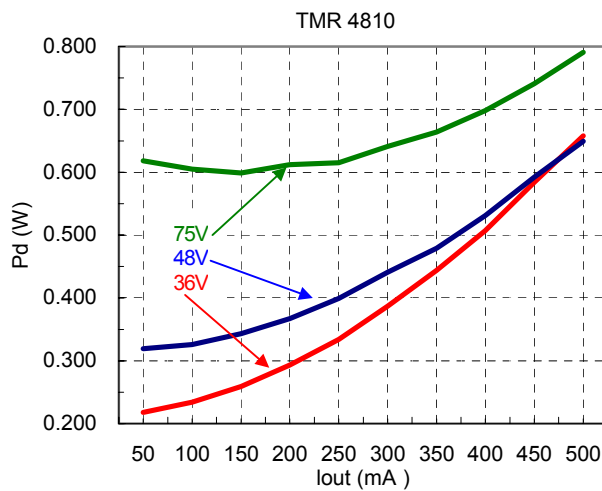
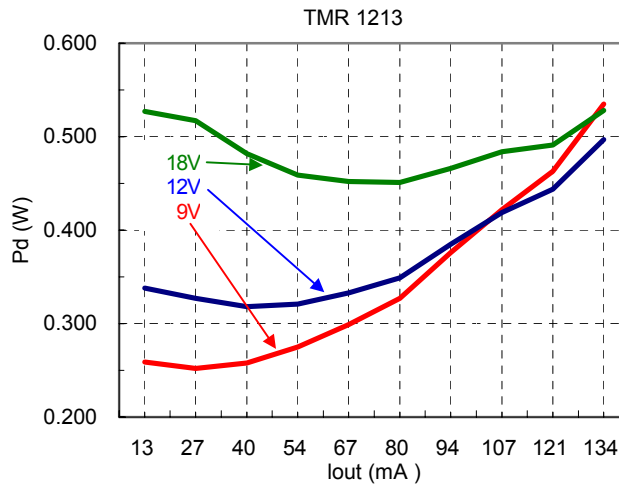
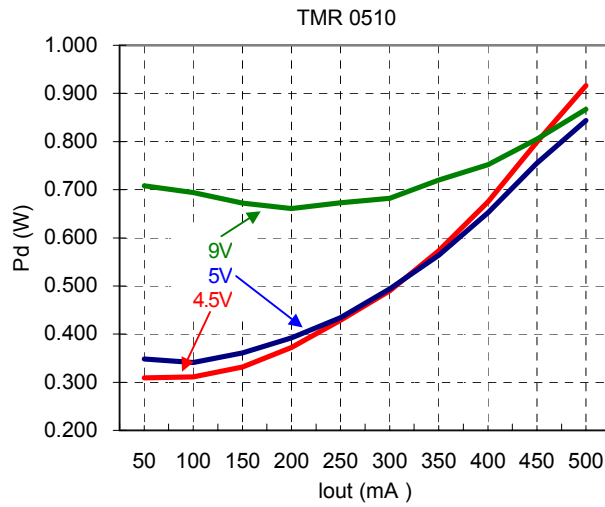

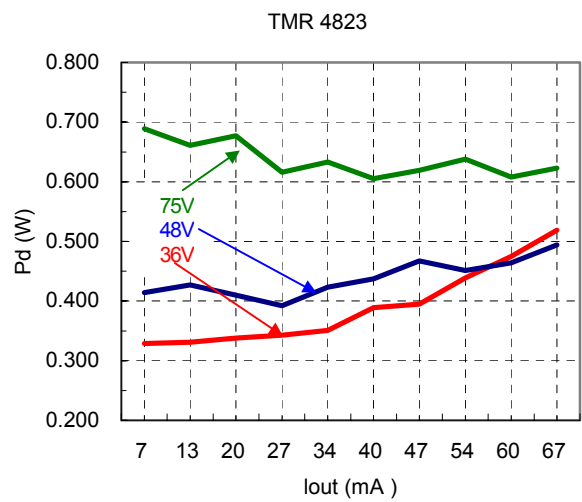
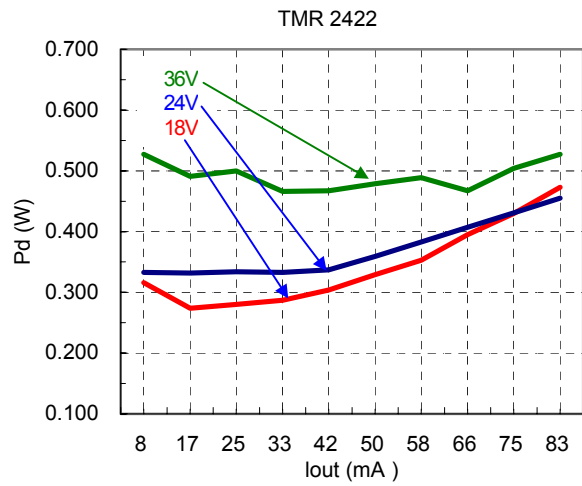
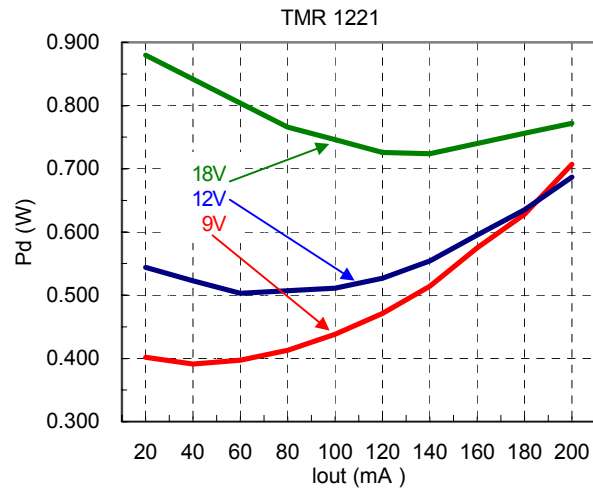

Output ripple & noise

TMR 0510

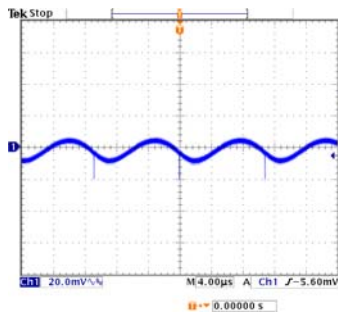

V_{inmin} , Full Load
Output Ripple & Noise = 26.8mV

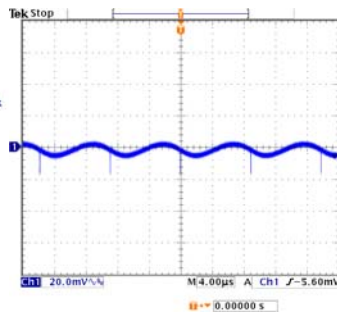

V_{innom} , Full Load
Output Ripple & Noise = 20.8mV

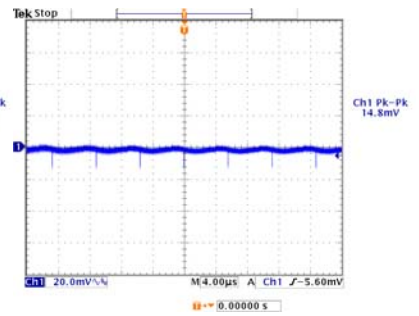

V_{inmax} , Full Load
Output Ripple & Noise = 14.8mV

TMR 1213

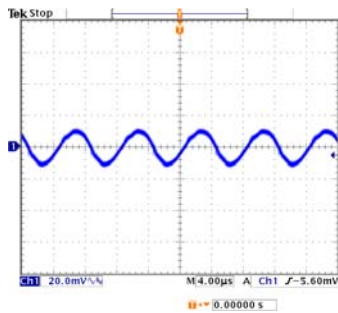

V_{inmin} , Full Load
Output Ripple & Noise = 25.2mV

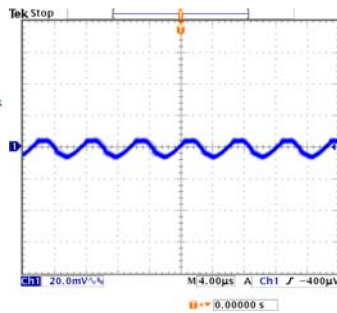

V_{innom} , Full Load
Output Ripple & Noise = 14.0mV

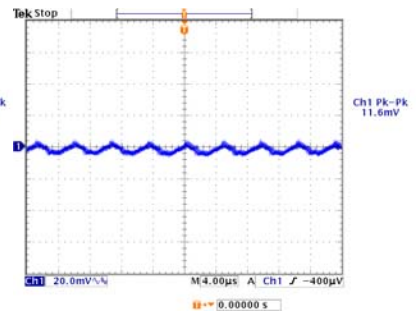

V_{inmax} , Full Load
Output Ripple & Noise = 11.6mV

TMR 4810

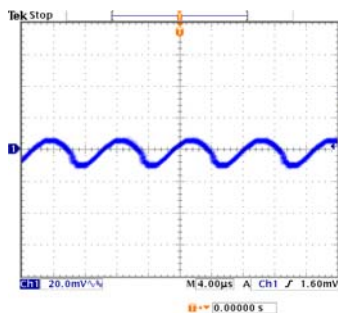

V_{inmin} , Full Load
Output Ripple & Noise = 20.0mV

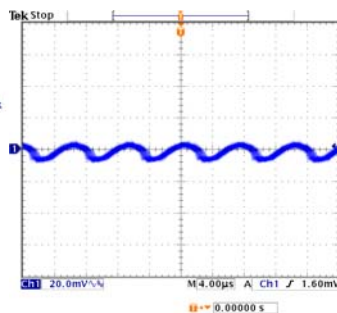

V_{innom} , Full Load
Output Ripple & Noise = 13.6mV

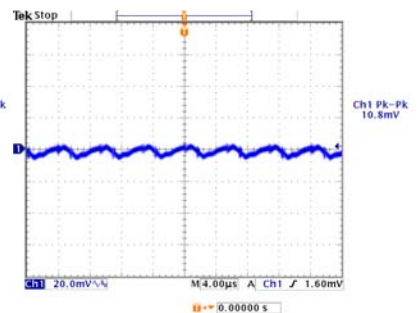

V_{inmax} , Full Load
Output Ripple & Noise = 10.8mV

TMR 1221

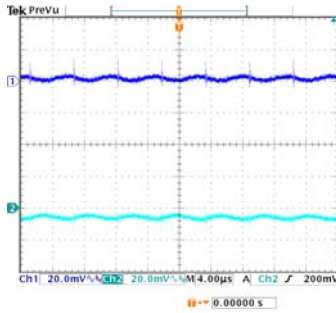

V_{inmin} , Full Load
 $+V_{out} = 18.8mV / -V_{out} = 14.4mV$

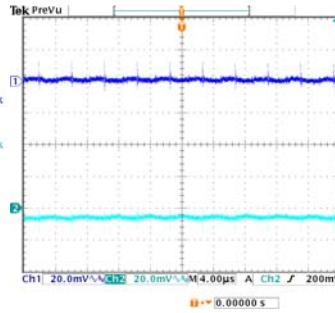

V_{innom} , Full Load
 $+V_{out} = 17.6mV / -V_{out} = 14.0mV$

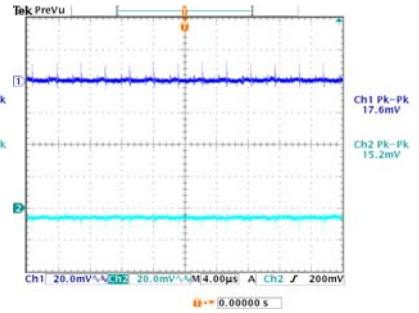

V_{inmax} , Full Load
 $+V_{out} = 17.6mV / -V_{out} = 15.2mV$

TMR 2422

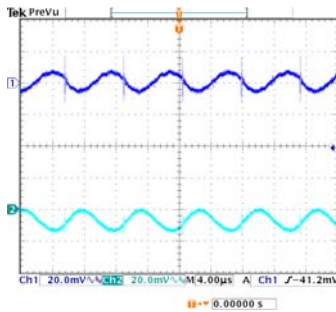

V_{inmin} , Full Load
 $+V_{out} = 30.8mV / -V_{out} = 19.2mV$

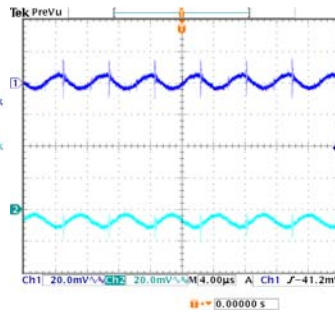

V_{innom} , Full Load
 $+V_{out} = 25.6mV / -V_{out} = 18.0mV$

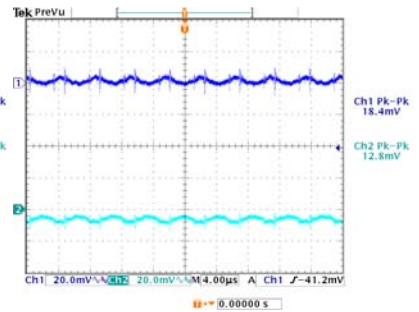

V_{inmax} , Full Load
 $+V_{out} = 18.4mV / -V_{out} = 12.8mV$

TMR 4823

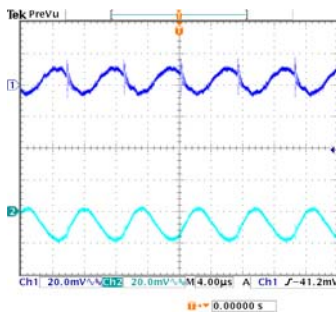

V_{inmin} , Full Load
 $+V_{out} = 26.8mV / -V_{out} = 24.4mV$

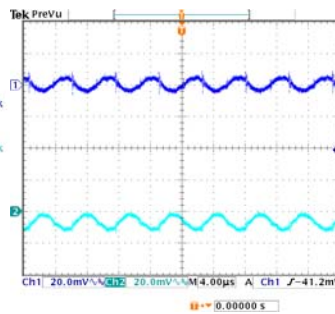

V_{innom} , Full Load
 $+V_{out} = 14.8mV / -V_{out} = 14.0mV$

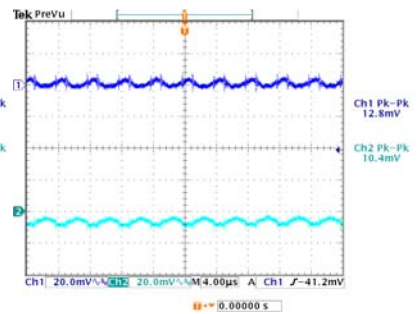

V_{inmax} , Full Load
 $+V_{out} = 12.8mV / -V_{out} = 10.4mV$

Transient Peak and Response

TMR 0510

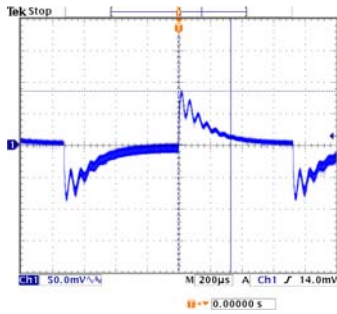

V_{inmin} , Full Load
 Transient Peak 85.0mV
 Transient Response 332.0µs

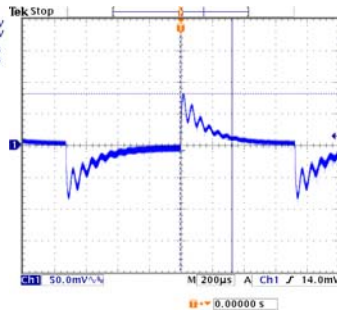

V_{innom} , Full Load
 Transient Peak 81.0mV
 Transient Response 328.0µs

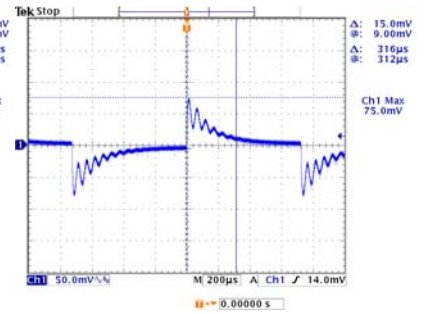

V_{inmax} , Full Load
 Transient Peak 75.0mV
 Transient Response 316.0µs

TMR 1213

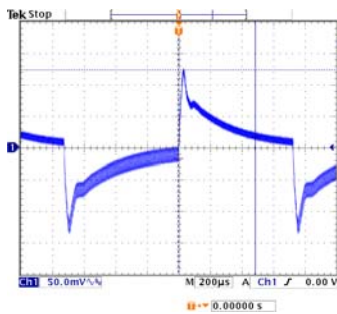

V_{inmin} , Full Load
 Transient Peak 123.0mV
 Transient Response 488µs

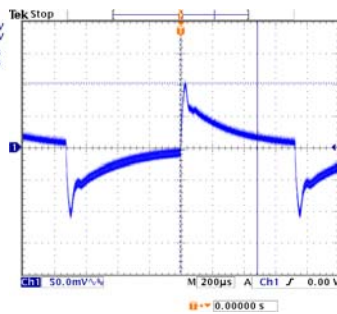

V_{innom} , Full Load
 Transient Peak 102.0mV
 Transient Response 488µs

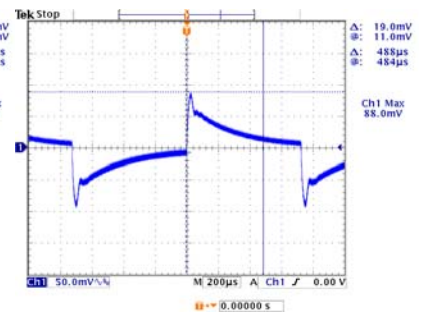

V_{inmax} , Full Load
 Transient Peak 88.0mV
 Transient Response 488µs

TMR 4810

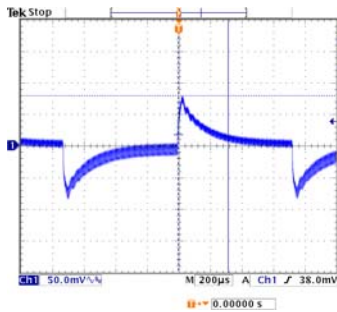

V_{inmin} , Full Load
 Transient Peak 79.0mV
 Transient Response 316µs

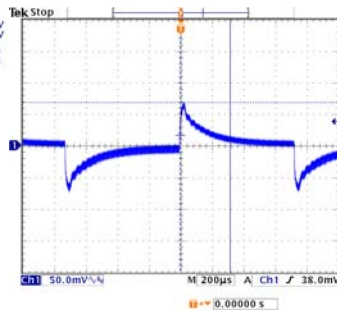

V_{innom} , Full Load
 Transient Peak 68.0mV
 Transient Response 316µs

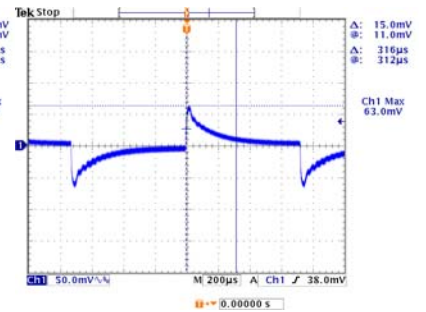

V_{inmax} , Full Load
 Transient Peak 63.0mV
 Transient Response 316µs

TMR 1221

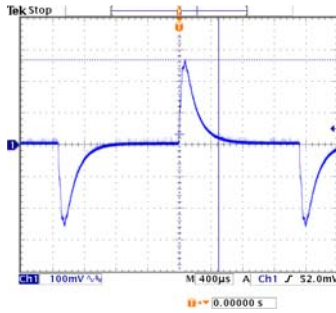

V_{inmin} , Full Load
 Transient Peak 270mV
 Transient Response 496µs

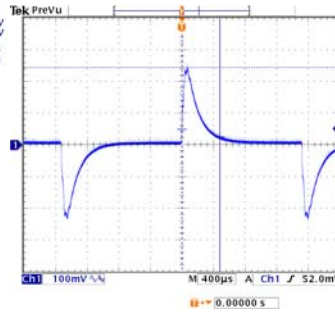

V_{innom} , Full Load
 Transient Peak 246mV
 Transient Response 480µs

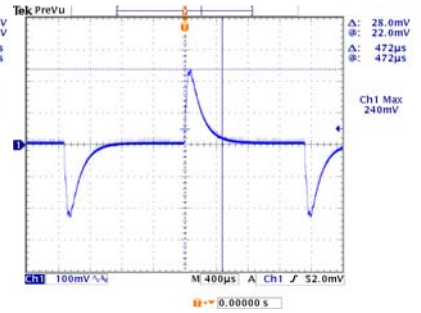

V_{inmax} , Full Load
 Transient Peak 240mV
 Transient Response 472µs

TMR 2422

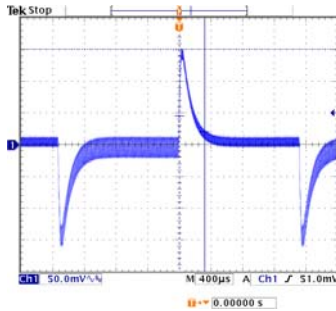

V_{inmin} , Full Load
 Transient Peak 152mV
 Transient Response 320µs

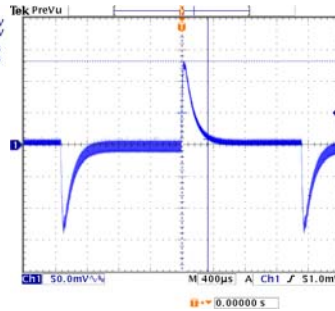

V_{innom} , Full Load
 Transient Peak 133mV
 Transient Response 328µs

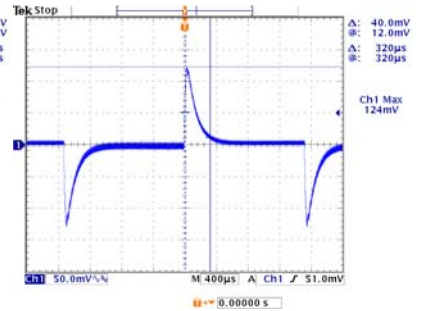

V_{inmax} , Full Load
 Transient Peak 124mV
 Transient Response 320µs

TMR 4823

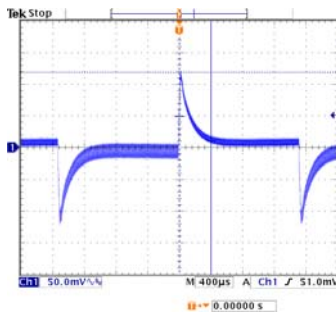

V_{inmin} , Full Load
 Transient Peak 119mV
 Transient Response 400µs

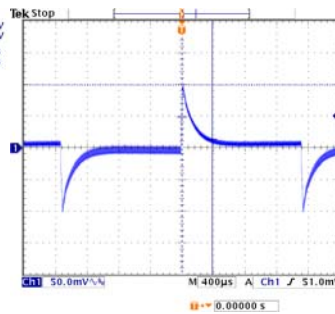

V_{innom} , Full Load
 Transient Peak 100mV
 Transient Response 384µs

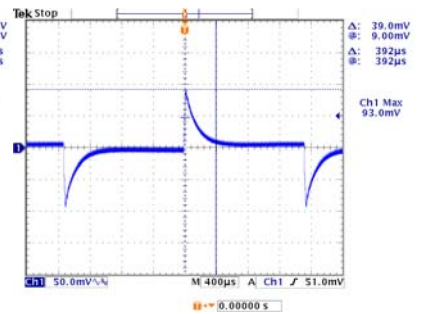

V_{inmax} , Full Load
 Transient Peak 93mV
 Transient Response 392µs

Start-up Time and Rise Time

TMR 0510

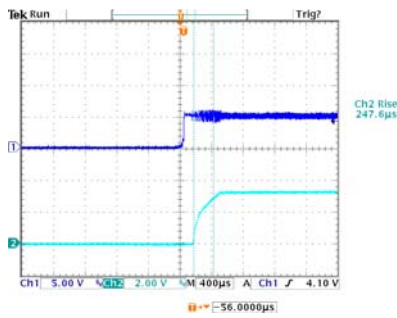

$V_{in, nom}$, Full Load
Rise Time = 247.6µS

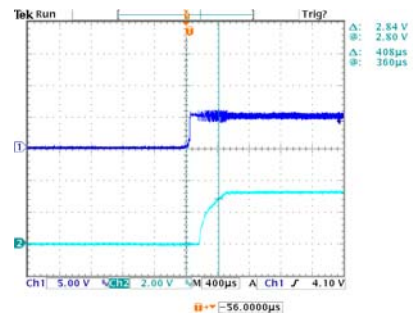

$V_{in, nom}$, Full Load
Start-up Time = 408.0µS

TMR 1213

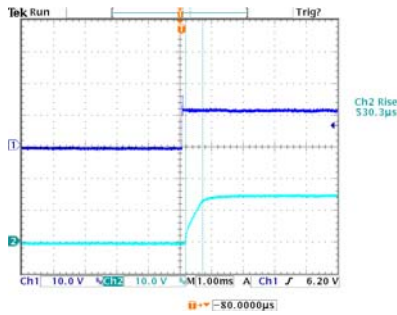

$V_{in, nom}$, Full Load
Rise Time = 530.3µS

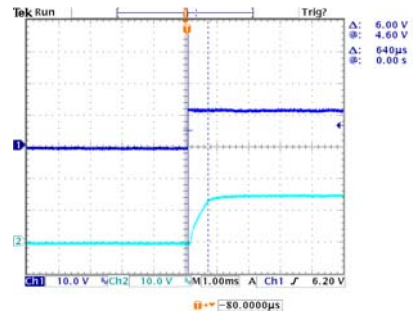

$V_{in, nom}$, Full Load
Start-up Time = 640.0µS

TMR 4810

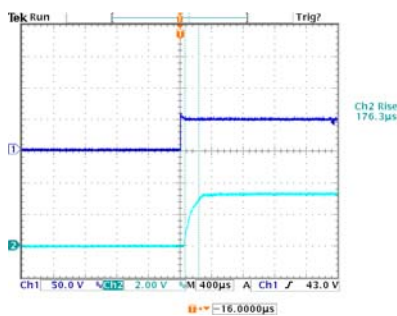

$V_{in, nom}$, Full Load
Rise Time = 176.3µS

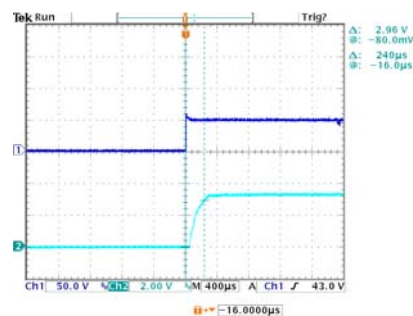

$V_{in, nom}$, Full Load
Start-up Time = 240.0µS

TMR 1221

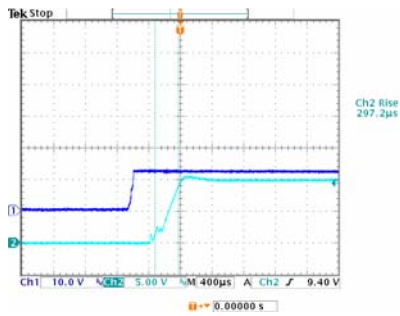

$V_{in,nom}$, Full Load
Rise Time = 297.2µS

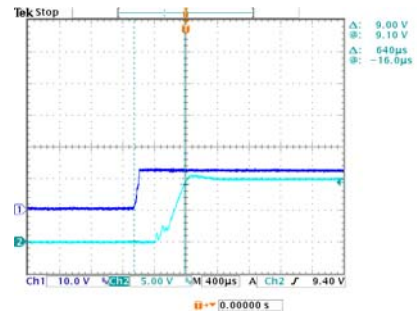

$V_{in,nom}$, Full Load
Start-up Time = 640.0µS

TMR 2422

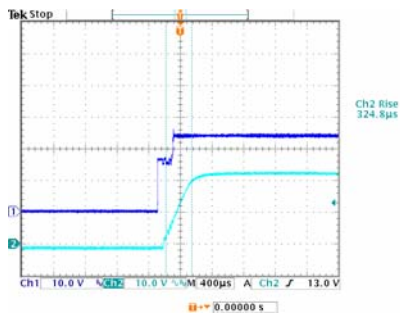

$V_{in,nom}$, Full Load
Rise Time = 324.8µS

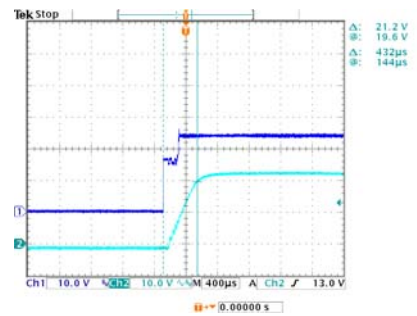

$V_{in,nom}$, Full Load
Start-up Time = 432.0µS

TMR 4823

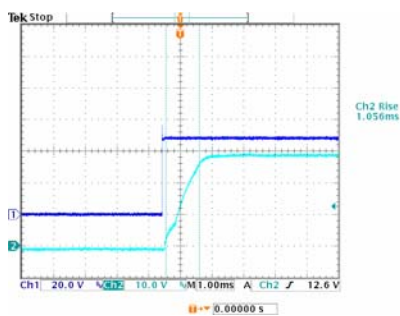

$V_{in,nom}$, Full Load
Rise Time=1.056mS

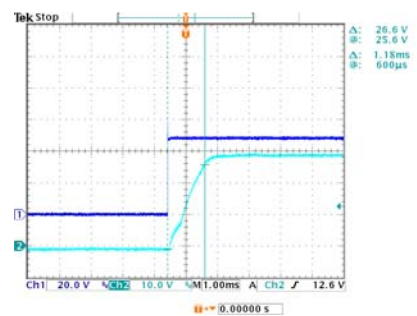

$V_{in,nom}$, Full Load
Start-up Time= 1.180mS

Thermal Consideration

The power module operates in a variety of thermal environments. However, sufficient cooling should be provided to help ensure reliable operation of the unit. Heat is removed by conduction, convection, and radiation to the surrounding Environment. Proper cooling can be verified by measuring the point as shown in the figure below. The temperature at this location should not exceed 100°C. During performance, adequate cooling must be provided to maintain the test point temperature at or below 100°C. Although the maximum point Temperature of the power modules is 100°C, you can limit the case temperature to a lower value for high reliability.

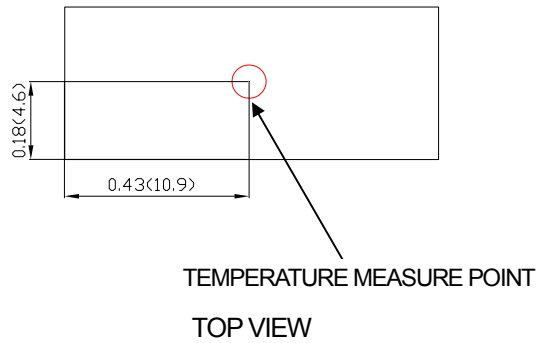

Measurement shown in inches and (millimeters)

Part Number Structure

TMR 4812

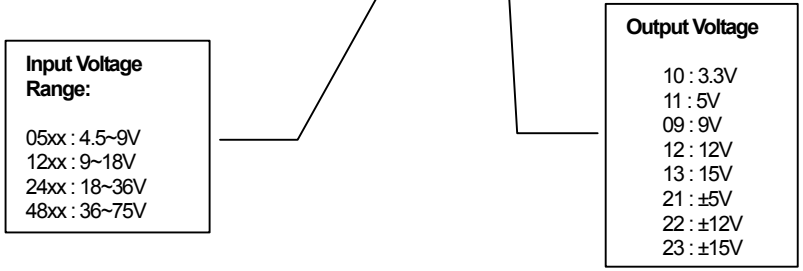

EMC Specifications

EN61000-4-2 ESD (performance criteria B)	Contact discharge		Air discharge	
	level	test voltage (KV)	level	test voltage (KV)
	1	±2	1	±2
	2	±4	2	±4
	3	±6	3	±8
	4	±8	4	±15
EN61000-4-3 RS (performance criteria B)	level	test field strength (V/m)		
	1	1		
	2	3		
	3	10		

EMC Specifications (continue)		
EN61000-4-4 EFT (performance criteria B)	open circuit output test voltage $\pm 10\%$	
	level	power line
	1	$\pm 0.5\text{KV}$
	2	$\pm 1.0\text{KV}$
	3	$\pm 2.0\text{KV}$
EN61000-4-5 Surge (performance criteria B)	open circuit output test voltage $\pm 10\%$	
	level	
	1	$\pm 0.5\text{KV}$
	2	$\pm 1.0\text{KV}$
	3	$\pm 2.0\text{KV}$
EN61000-4-6 CS (performance criteria B)	level	voltage level(EMF)
	1	1V/rms
	2	3V/rms
	3	10V/rms

Mechanical Data

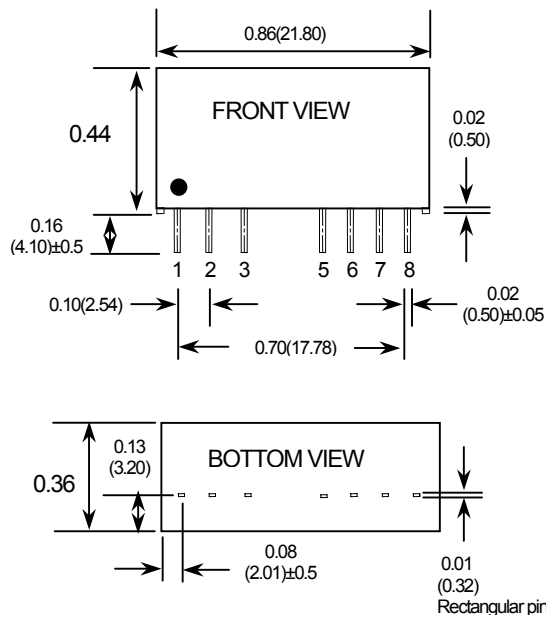

All Dimensions in Inches (mm)
 Tolerance: X.XX ± 0.02 (X.X ± 0.5)
 X.XXX ± 0.01 (X.XX ± 0.25)
 Pin Pitch Tolerance ± 0.02 (0.5)

PIN CONNECTION		
PIN	SINGLE	DUAL OUTPUT
1	- INPUT	- INPUT
2	+ INPUT	+ INPUT
3	CTRL	CTRL
5	NC	NC
6	+ OUTPUT	+ OUTPUT
7	- OUTPUT	COM
8	NC	- OUTPUT

Safety and Installation Instruction

Isolation consideration

The TMR series features 1.0k Volt DC isolation for 60 seconds from input to output, input to case, and output to case. The input to output resistance is greater than 10^9 ohms. Nevertheless, if the system using the TMR converter needs to get safety agency approval, certain rules must be followed in the design of the system. In particular, all of the creepage and clearance requirements of the end-use safety requirement must be observed. These documents include UL60950-1, EN60950-1 and CSA 22.2-60950, although specific applications may have other or additional requirements.

Fusing Consideration

Caution: The TMR converter is not internally fused. An input line fuse must always be used. This encapsulated power module can be used in a wide variety of applications, ranging from simple stand-alone operation to an integrated part of a sophisticated power architecture. To maximum flexibility, internal fusing is not included; however, to achieve maximum safety and system protection, always use an input line fuse. The safety agencies require a slow-blow fuse with maximum rating of 6.3 A. Based on the information provided in this data sheet on inrush energy and maximum dc input current, the same type of fuse with lower rating can be used.

Minimum Load Requirement

25% (of full load) minimum load required to maintain a stable output voltage and to comply with the published specifications. The TMR Series is not getting damaged at no load or low load conditions but at loads below 25% a proper and accurate regulation of the output voltage cannot be ensured. The output voltage drops by app. 10%.

MTBF and Reliability

The MTBF of TMR series has been calculated according to:

1. MIL-HDBK-217F under the following conditions:

Nominal Input Voltage and GB

$$I_{out} = I_{out,max}$$

$$T_A = +25^{\circ}\text{C}$$

The resulting figure for MTBF is 2.399×10^6 hours.

2. Bell-core TR-NWT-000332 Case I:

50% stress, Operating Temperature at 40°C (Ground fixed and controlled environment)

The resulting figure for MTBF is 5.107×10^6 hours.