

To our customers,

---

## Old Company Name in Catalogs and Other Documents

---

On April 1<sup>st</sup>, 2010, NEC Electronics Corporation merged with Renesas Technology Corporation, and Renesas Electronics Corporation took over all the business of both companies. Therefore, although the old company name remains in this document, it is a valid Renesas Electronics document. We appreciate your understanding.

Renesas Electronics website: <http://www.renesas.com>

April 1<sup>st</sup>, 2010  
Renesas Electronics Corporation

Issued by: Renesas Electronics Corporation (<http://www.renesas.com>)

Send any inquiries to <http://www.renesas.com/inquiry>.

## Notice

1. All information included in this document is current as of the date this document is issued. Such information, however, is subject to change without any prior notice. Before purchasing or using any Renesas Electronics products listed herein, please confirm the latest product information with a Renesas Electronics sales office. Also, please pay regular and careful attention to additional and different information to be disclosed by Renesas Electronics such as that disclosed through our website.
2. Renesas Electronics does not assume any liability for infringement of patents, copyrights, or other intellectual property rights of third parties by or arising from the use of Renesas Electronics products or technical information described in this document. No license, express, implied or otherwise, is granted hereby under any patents, copyrights or other intellectual property rights of Renesas Electronics or others.
3. You should not alter, modify, copy, or otherwise misappropriate any Renesas Electronics product, whether in whole or in part.
4. Descriptions of circuits, software and other related information in this document are provided only to illustrate the operation of semiconductor products and application examples. You are fully responsible for the incorporation of these circuits, software, and information in the design of your equipment. Renesas Electronics assumes no responsibility for any losses incurred by you or third parties arising from the use of these circuits, software, or information.
5. When exporting the products or technology described in this document, you should comply with the applicable export control laws and regulations and follow the procedures required by such laws and regulations. You should not use Renesas Electronics products or the technology described in this document for any purpose relating to military applications or use by the military, including but not limited to the development of weapons of mass destruction. Renesas Electronics products and technology may not be used for or incorporated into any products or systems whose manufacture, use, or sale is prohibited under any applicable domestic or foreign laws or regulations.
6. Renesas Electronics has used reasonable care in preparing the information included in this document, but Renesas Electronics does not warrant that such information is error free. Renesas Electronics assumes no liability whatsoever for any damages incurred by you resulting from errors in or omissions from the information included herein.
7. Renesas Electronics products are classified according to the following three quality grades: “Standard”, “High Quality”, and “Specific”. The recommended applications for each Renesas Electronics product depends on the product’s quality grade, as indicated below. You must check the quality grade of each Renesas Electronics product before using it in a particular application. You may not use any Renesas Electronics product for any application categorized as “Specific” without the prior written consent of Renesas Electronics. Further, you may not use any Renesas Electronics product for any application for which it is not intended without the prior written consent of Renesas Electronics. Renesas Electronics shall not be in any way liable for any damages or losses incurred by you or third parties arising from the use of any Renesas Electronics product for an application categorized as “Specific” or for which the product is not intended where you have failed to obtain the prior written consent of Renesas Electronics. The quality grade of each Renesas Electronics product is “Standard” unless otherwise expressly specified in a Renesas Electronics data sheets or data books, etc.
  - “Standard”: Computers; office equipment; communications equipment; test and measurement equipment; audio and visual equipment; home electronic appliances; machine tools; personal electronic equipment; and industrial robots.
  - “High Quality”: Transportation equipment (automobiles, trains, ships, etc.); traffic control systems; anti-disaster systems; anti-crime systems; safety equipment; and medical equipment not specifically designed for life support.
  - “Specific”: Aircraft; aerospace equipment; submersible repeaters; nuclear reactor control systems; medical equipment or systems for life support (e.g. artificial life support devices or systems), surgical implantations, or healthcare intervention (e.g. excision, etc.), and any other applications or purposes that pose a direct threat to human life.
8. You should use the Renesas Electronics products described in this document within the range specified by Renesas Electronics, especially with respect to the maximum rating, operating supply voltage range, movement power voltage range, heat radiation characteristics, installation and other product characteristics. Renesas Electronics shall have no liability for malfunctions or damages arising out of the use of Renesas Electronics products beyond such specified ranges.
9. Although Renesas Electronics endeavors to improve the quality and reliability of its products, semiconductor products have specific characteristics such as the occurrence of failure at a certain rate and malfunctions under certain use conditions. Further, Renesas Electronics products are not subject to radiation resistance design. Please be sure to implement safety measures to guard them against the possibility of physical injury, and injury or damage caused by fire in the event of the failure of a Renesas Electronics product, such as safety design for hardware and software including but not limited to redundancy, fire control and malfunction prevention, appropriate treatment for aging degradation or any other appropriate measures. Because the evaluation of microcomputer software alone is very difficult, please evaluate the safety of the final products or system manufactured by you.
10. Please contact a Renesas Electronics sales office for details as to environmental matters such as the environmental compatibility of each Renesas Electronics product. Please use Renesas Electronics products in compliance with all applicable laws and regulations that regulate the inclusion or use of controlled substances, including without limitation, the EU RoHS Directive. Renesas Electronics assumes no liability for damages or losses occurring as a result of your noncompliance with applicable laws and regulations.
11. This document may not be reproduced or duplicated, in any form, in whole or in part, without prior written consent of Renesas Electronics.
12. Please contact a Renesas Electronics sales office if you have any questions regarding the information contained in this document or Renesas Electronics products, or if you have any other inquiries.

(Note 1) “Renesas Electronics” as used in this document means Renesas Electronics Corporation and also includes its majority-owned subsidiaries.

(Note 2) “Renesas Electronics product(s)” means any product developed or manufactured by or for Renesas Electronics.

## 78K0/LE2

### 8-BIT SINGLE-CHIP MICROCONTROLLER

The 78K0/LE2 products are 8-bit single-chip microcontrollers of the 78K0 series.

These microcontrollers feature Single-voltage Self-programming Flash memory, LCD C/D and many peripherals.

#### FEATURES

- 78K0 CPU core, 8-bit CISC architecture
- Flash EEPROM and RAM sizes

Product name	Item	Program memory	Data memory
uPD78F0363		32K bytes (Flash)	1K bytes
uPD78F0361		16K bytes (Flash)	768 bytes

#### Minimum instruction cycle

0.1  $\mu$ s (20MHz@4.0V to 5.5V)

0.2  $\mu$ s (10MHz@2.7V to 5.5V)

0.4  $\mu$ s (5MHz@1.8V to 5.5V)

#### Clock

- Main clock
  - Internal Ring-oscillator 8MHz (Typ.)
  - External Ceramic or Crystal Oscillator(2MHz to 20MHz)  
(Instruction execution time = 100ns(min.) @20MHz)

#### SUB CLOCK

- 32.768KHz Crystal oscillator

#### WDT CLOCK

- Internal Ring-oscillator 240KHz (Typ.)

#### Peripherals

- On-Chip Power-On-Clear(POC) Circuit
- Low-Voltage Detector(LVI) Circuit
- Timer
  - 16bit Timer 1ch
  - 8bit Timer 4ch
  - Watch Timer
  - Watchdog Timer (Operable with 240KHz Ring-OSC)

#### Serial I/F

- UART0/CSI1 1ch
- UART6 (with LIN-bus) 1ch
- IIC 1ch

#### LCD C/D

- Segment signal output 20 (max)
- Common signal output 4 (max)
- booster type or ladder type selectable

#### A/D Converter

- 10-bit resolution A/D converter 5ch

#### I/O port

- CMOS I/O : 24 + IIC : 2

#### Operation Voltage : 1.8V to 5.5V

#### Package

- 64-pin QFP(12mm x 12mm, 0.65mm pitch)
- 64-pin QFP(10mm x 10mm, 0.5mm pitch)

#### Other

- On-chip debug function\*

\* uPD78F0363D

)

This information contained in this document is being issued in advance of the production cycle for the product. The parameters for the product may change before final production or NEC Electronics Corporation, at its own discretion.

1. Block Diagram

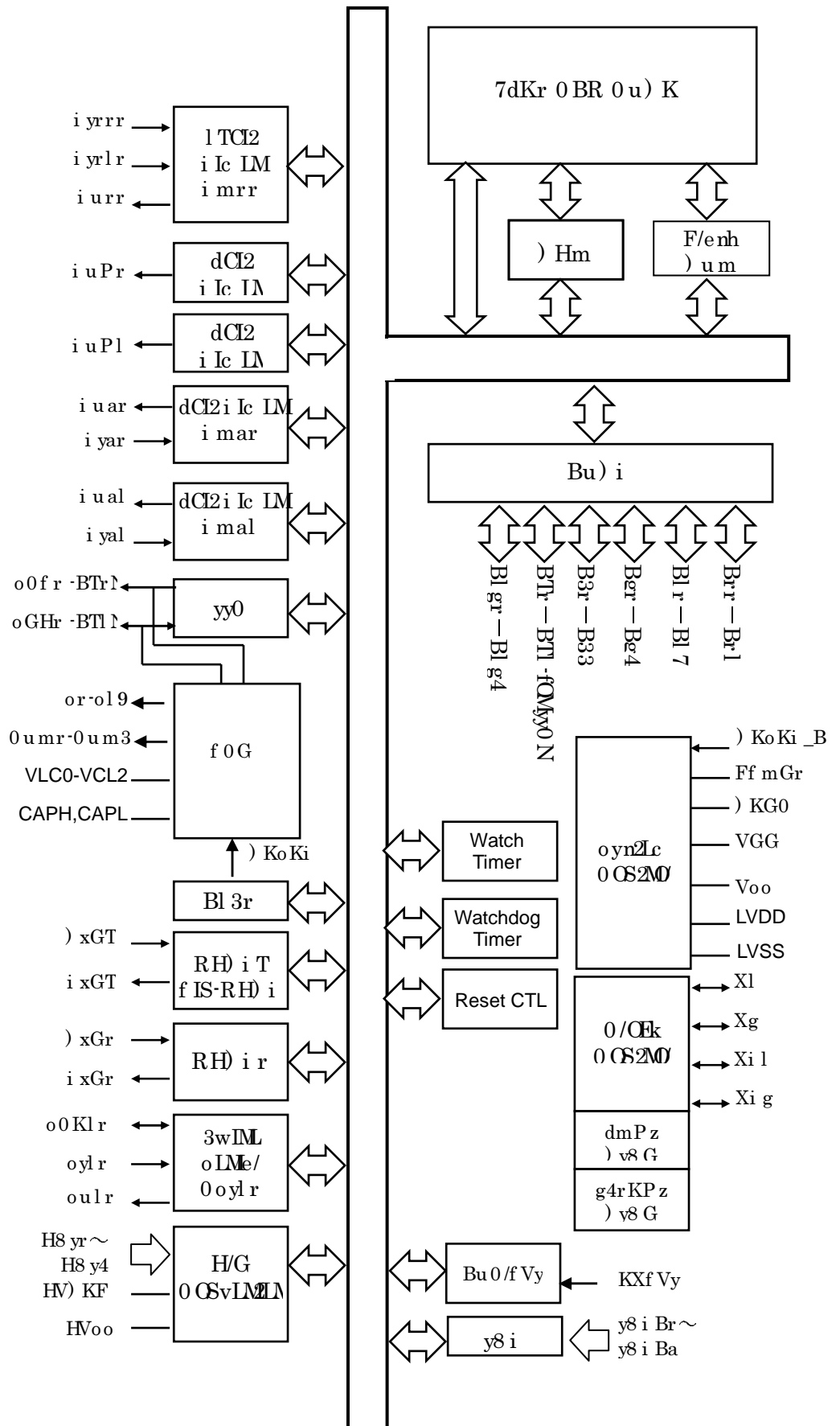

## 2. Pin Function (uPD78F0373, uPD78F0375)

PIN NAME	Function
VDD	Positive power supply
VSS	Ground potential
LVDD	Positive power supply
LVSS	Ground potential
RESET_B	System reset input
FLMD0	Flash EEPROM programming mode setting
REGC	Connecting regulator stabilization capacitor. Connect to GND via a capacitor (0.47 $\mu$ F)
AVREF	A/D converter analog power supply and power supply for P20-P24
AVSS	Ground potential for A/D converter and P20 - P24
VLC0 VLC1 VLC2	LCD driving voltage <ul style="list-style-type: none"> <li>• VLC0: Three times VLC2 output voltage</li> <li>• VLC1: Two times VLC2 output voltage</li> <li>• VLC2: Reference voltage</li> </ul>
CAPH CAPL	Booster capacitor connection for LCD drive voltage
COM0-COM3	LCD controller/driver common signal output
P00 /TI000	I/O port External count clock input to 16-bit timer/event counter 00 Capture trigger input to capture registers (CR000, CR010) of 16-bit timer/event counter 00 (TM00)
P01 /TI010 /TO00	I/O port Capture trigger input to capture register (CR000) of 16-bit timer/event counter 00 (TM00) 16-bit timer/event counter 00 output (TM00) 16-bit timer/event counter 01 output (TM01)
P10 /SCK10 /TXD0	I/O port Clock input/ output for serial interface (CSI10) Serial data output from asynchronous serial interface (UART0)
P11 /SI10 /RXD0	I/O port Serial data input to serial interface (CSI10) Serial data input to asynchronous serial interface (UART0)
P12 /SO10	I/O port Serial data output form serial interface (CSI10)
P13 /TXD6	I/O port Serial data output from asynchronous serial interface (UART6)
P14 /RXD6	I/O port Serial data input to asynchronous serial interface (UART6)
P15 /TOH0	I/O port 8-bit timer H0 output (TMH0)
P16 /TOH1 /INTP5	I/O port 8-bit timer H1 output (TMH1) External interrupt request input with specifiable valid edges
P17 /TI50 /TO50	I/O port External count clock input to 8-bit timer/event counter 50 (TM50) 8-bit timer/event counter 50 output (TM50)
P20/ANI0- P24/ANI7	I/O port port/Analog input of A/D converter
P30/INTP1 P31/INTP2 P32/INTP3	I/O port External interrupt request input with specifiable valid edges
P33 /TI51 /TO51 /INTP4	I/O port External count clock input to 8-bit timer/event counter 51(TM51) 8-bit timer/event counter 51output(TM51) External interrupt request input with specifiable valid edges

(P60) /SCL0	(IIC only) Clock input/ output for serial interface (IIC0)
(P61) /SDA0	(IIC only) Serial data input/ output for serial interface (IIC0)
P120 /INTP0 /EXLVI	I/O port External interrupt request input with specifiable valid edges Reference voltage input for Low voltage Indicator
P121 /X1	I/O port (An external oscillation circuit is not used) Connecting resonator for main system clock oscillation
P122 /X2	I/O port (An external oscillation circuit is not used) Crystal connection for main system clock oscillation
P123 /XT1	I/O port (An external oscillation circuit is not used) Crystal connection for subsystem clock oscillation
P124 /XT2	I/O port (An external oscillation circuit is not used) Crystal connection for subsystem clock oscillation
S0-S19	LCD controller/driver segment signal output

## 3. Pin Lay Out

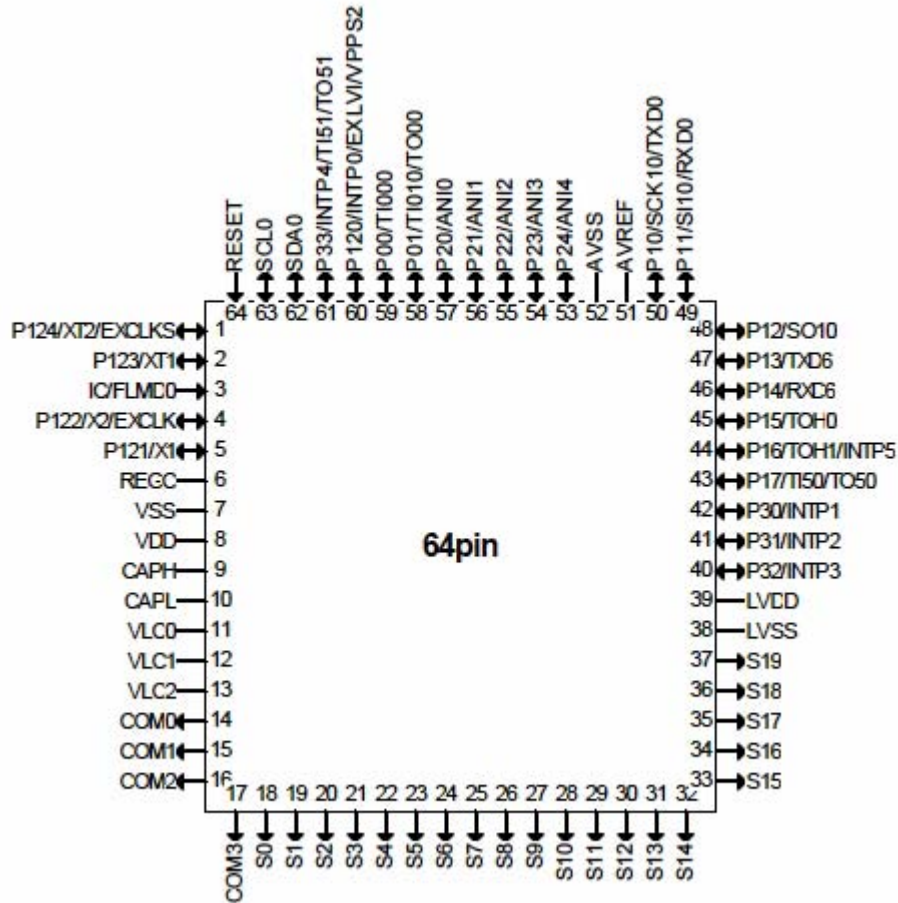

## 4. Memory space

78K0/LE2 have 64KB linear address area.

Products	ROM size	ROM address	ROM address		Number of Bank
			Common area address	Bank area address	
$\mu$ PD78F0363	32KB	0000H-7FFFH	-	-	-
$\mu$ PD78F0341	16KB	0000H-3FFFH	-	-	-

## 5. Clock

78K0/LE2 have 3 type internal Ring-OSC and 2 type external resonator oscillation circuit.

78K0/LE2 can be operated high-speed internal Ring-OSC only. 240KHz Ring-OSC can connect to Watch dog timer and 8bit timer (TMH1) only for high secure.

Fig. Clock connecting block image

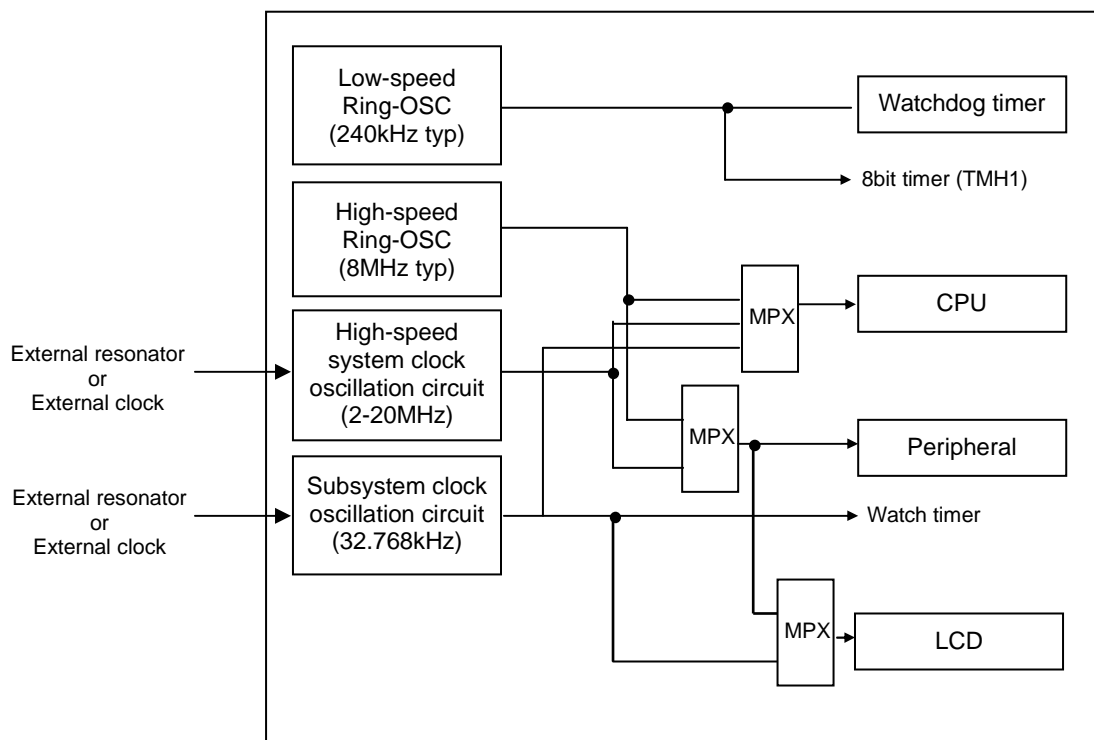



## 6. Outline of Functions of 78K0/Lx2

**Table 78K0/Lx2 Functions**

			LE2	LF2	LF2F	LG2			
Package			64	80		100			
CPU			8bit CPU						
Oscillation circuit	Main	Cera/ Crystal	Vdd=4.0V-5.5V:20MHz Vdd=2.7V-5.5V:10MHz Vdd=1.8V-5.5V:5MHz						
		Ring OSC	Vdd=1.8V-5.5V:8MHz						
	Ring-OSC		Vdd=2.7V-5.5V:240KHz						
	Sub Clock		32.768KHz						
VDD			1.8V-5.5V						
Flash ROM (K byte)			16/32	32	60	32	60	32	60/128
RAM (K byte)			768/1	1	3	1	3	1	3/7
LCD Segment (MAX.)			80	104	144		160		
Timer	16bit	TM0	1	2	1	2	1	2	
	8bit	TM5	2						
		TMH	2						
	WDT		1						
	WT		1						
Serial	3SIO/UART		1						
	3SIO		-						1
	UART		1						
	IIC*		1						
10bit A/D			5ch	8ch	-		8ch		
Key return			-	7pins			8pins		
Multiplier/Divider			-	Yes	-	Yes	-	Yes	
LVI/POC			Yes						
Flash Self Programming			Yes						

\*Shared with internal communication

## 7. Electrical specification of LE2 (Target)

**Caution** These specifications show target values, which may change after device evaluation. The operating voltage range may also change.

Absolute Maximum Ratings( $T_A = 25^\circ \text{C}$ )

Parameter	Symbol	Conditions	Ratings	Unit	
Supply voltage	VDD	VDD=LVDD	-0.5 to +6.5	V	
	LVDD	VDD=LVDD	-0.5 to +6.5	V	
	VSS		-0.5 to +0.3	V	
	LVSS		-0.5 to +0.3	V	
	AVREF		-0.5 to VDD+0.3 <sup>Note</sup>	V	
	AVSS		-0.5 to +0.3	V	
Input voltage	VI1	P00-P01,P10-P17,P20-P24,P30-P33, P120-P124, X1,X2,Xt1,Xt2,RESET_B	-0.3 to VDD+0.3 <sup>Note</sup>	V	
	VI2	P60-P61(N-ch open drain)	-0.3 to +6.5	V	
Output voltage	VO		-0.3 to VDD+0.3 <sup>Note</sup>	V	
Analog input voltage	VAN		-0.3 to AVREF+0.3 <sup>Note</sup> and -0.3 to VDD+0.3 <sup>Note</sup>	V	
Output current, high	IOH	Per pin	-10	mA	
		Total of all pins -80 mA	P00-P01, P120-P124	-25	mA
			P05-P06,P10-P17,P30-P33	-55	mA
Output current, low	IOL	Per pin	30	mA	
		Total of all pins 200 mA	P00-P01, P120-P124	60	mA
			P10-P17,P30-P33, P60-P61	140	mA
Operating ambient temperature	TA	In normal operation mode	-40 to +85	°C	
		In flash memory programming mode			
Storage temperature	T <sub>stg</sub>		-65 to +150	°C	

**Note** Must be 6.5 V or lower.

**Caution** Product quality may suffer if the absolute maximum rating is exceeded even momentarily for any parameter. That is, the absolute maximum ratings are rated values at which the product is on the verge of suffering physical damage, and therefore the product must be used under conditions that ensure that the absolute maximum ratings are not exceeded.

**Remark** Unless specified otherwise, the characteristics of alternate-function pins are the same as those of port pins.

## High-Speed System Clock (Crystal/Ceramic) Oscillator Characteristics

(TA = -40 to +85°C, 1.8 V < VDD = LVDD < 5.5 V, 2.3 V < AVREF < VDD = LVDD, VSS = LVSS = AVSS = 0 V)

Resonator	Recommended Circuit	Conditions	MIN.	TYP.	MAX.	Unit
Ceramic resonator		Oscillation frequency( $f_{XH}$ ) <sup>Note</sup>	4.0 V < V <sub>DD</sub> < 5.5 V	2.0		20.0
			2.7 V < V <sub>DD</sub> < 4.0 V	2.0		10.0
			1.8 V < V <sub>DD</sub> < 2.7 V	2.0		5.0
Crystal resonator		Oscillation frequency( $f_{XH}$ ) <sup>Note</sup>	4.0 V < V <sub>DD</sub> < 5.5 V	2.0		20.0
			2.7 V < V <sub>DD</sub> < 4.0 V	2.0		10.0
			1.8 V < V <sub>DD</sub> < 2.7 V	2.0		5.0

**Note** Indicates only oscillator characteristics. Refer to AC Characteristics for instruction execution time.

### Cautions

1. When using the subsystem clock oscillator, wire as follows in the area enclosed by the broken lines in the above figures to avoid an adverse effect from wiring capacitance.

- **Keep the wiring length as short as possible.**
- **Do not cross the wiring with the other signal lines.**
- **Do not route the wiring near a signal line through which a high fluctuating current flows.**
- **Always make the ground point of the oscillator capacitor the same potential as V<sub>ss</sub>.**
- **Do not ground the capacitor to a ground pattern through which a high current flows.**
- **Do not fetch signals from the oscillator.**

2. Since the CPU is started by the Ring-OSC after reset is released, check the oscillation stabilization time of the high-speed system clock using the oscillation stabilization time status register (OSTC). Determine the oscillation stabilization time of the OSTC register and oscillation stabilization time select register (OSTS) after sufficiently evaluating the oscillation stabilization time with the resonator to be used.

**Remark** For the resonator selection and oscillator constant, customers are requested to either evaluate the oscillation themselves or apply to the resonator manufacturer for evaluation.

## Ring-OSC Oscillator Characteristics

(TA = -40 to +85°C, 1.8 V < VDD = LVDD < 5.5 V, 2.3 V < AVREF . VDD= LVDD, VSS = LVSS = AVSS = 0 V)

Resonator	Parameter		MIN.	TYP.	MAX.	Unit
8MHz Ring-OSC oscillator	High-speed Ring-OSC Oscillation frequency(fRH) <small>Note</small>	2.7 V < VDD < 5.5 V	7.6 <small>Note2</small>	8.0 <small>Note2</small>	8.4 <small>Note2</small>	MHz
		1.8 V < VDD < 2.7 V		8.0 <small>Note2</small>		MHz
240KHz Ring-OSC oscillator	Low-speed Ring-OSC Oscillation frequency(fRL) <small>Note</small>	2.7 V < VDD < 5.5 V	216	240	264	KHz
		1.8 V < VDD < 2.7 V	TBD	240	TBD	KHz

### Note

1. Indicates only oscillator characteristics. Refer to AC Characteristics for instruction execution time.
2. This is the frequency in the case of RSTS(RCM.7)=1. This is 5 MHz(TYP.) in the case of RSTS=0.

## Subsystem Clock Oscillator Characteristics

(TA = -40 to +85°C, 1.8 V < VDD = LVDD < 5.5 V, 2.3 V < AVREF . VDD= LVDD, VSS = LVSS = AVSS = 0 V)

Resonator	Recommended Circuit	Conditions	MIN.	TYP.	MAX.	Unit	
Crystal resonator		Oscillation frequency(fSUB) <small>Note</small>	1.8 V < VDD < 2.7 V	32	32.768	35	KHz

**Note** Indicates only oscillator characteristics. Refer to AC Characteristics for instruction execution time.

### Cautions

1. When using the subsystem clock oscillator, wire as follows in the area enclosed by the broken lines in the above figures to avoid an adverse effect from wiring capacitance.

- Keep the wiring length as short as possible.
- Do not cross the wiring with the other signal lines.
- Do not route the wiring near a signal line through which a high fluctuating current flows.
- Always make the ground point of the oscillator capacitor the same potential as Vss.
- Do not ground the capacitor to a ground pattern through which a high current flows.
- Do not fetch signals from the oscillator.

2. The subsystem clock oscillator is designed as a low-amplitude circuit for reducing power

**Remark** For the resonator selection and oscillator constant, customers are requested to either evaluate the oscillation themselves or apply to the resonator manufacturer for evaluation.

## DC Characteristics (1/3)

(TA = -40 to +85°C, 1.8V < VDD = LVDD < 5.5 V, VSS = EVSS = AVSS = 0 V)

Parameter	Symbol	Conditions	MIN.	TYP.	MAX.	Unit	
Output current, high	IOH1	Per pin of P00-P01, P10-P17, P30-P33, P120	4.0 V < VDD < 5.5 V		-3.0	mA	
			2.7 V < VDD < 4.0 V		-2.5		
			1.8 V < VDD < 2.7 V		-1.0		
		Total of P00-P01, P120		4.0 V < VDD < 5.5 V		-20.0	mA
				2.7 V < VDD < 4.0 V		-10.0	
				1.8 V < VDD < 2.7 V		-5.0	
		Total of P10-P17, P30-P33		4.0 V < VDD < 5.5 V		-30.0	mA
				2.7 V < VDD < 4.0 V		-19.0	
				1.8 V < VDD < 2.7 V		-10.0	
	Total of all pins		4.0 V < VDD < 5.5 V		-50.0	mA	
			2.7 V < VDD < 4.0 V		-29.0		
			1.8 V < VDD < 2.7 V		-15.0		
	IOH2	Per pin of P20-P24 <small>Note</small>	1.8 V < VDD < 5.5 V		-100		
	IOH3	Per pin of P121-P124	4.0 V < VDD < 5.5 V		-1.0	mA	
Output current, low	IOL1	Per pin of P00-P06, P10-P17, P30-P33, P120	4.0 V < VDD < 5.5 V		8.5	mA	
			2.7 V < VDD < 4.0 V		5.0		
			1.8 V < VDD < 2.7 V		2.0		
		Per pin of P60-P61		4.0 V < VDD < 5.5 V		15.0	mA
				2.7 V < VDD < 4.0 V		5.0	
				1.8 V < VDD < 2.7 V		2.0	
		Total of P00-P01, P120		4.0 V < VDD < 5.5 V		20.0	mA
				2.7 V < VDD < 4.0 V		15.0	
				1.8 V < VDD < 2.7 V		9.0	
		Total of P10-P17, P30-P33		4.0 V < VDD < 5.5 V		45.0	mA
				2.7 V < VDD < 4.0 V		35.0	
				1.8 V < VDD < 2.7 V		20.0	
	Total of all pins		4.0 V < VDD < 5.5 V		65.0	mA	
			2.7 V < VDD < 4.0 V		50.0		
			1.8 V < VDD < 2.7 V		29.0		
	IOL2	Per pin of P20-P24 <small>Note</small>	1.8 V < VDD < 5.5 V		400	uA	
	IOL3	Per pin of P121-P124	4.0 V < VDD < 5.5 V		1.0	mA	
Input voltage, high	VIH1	P12, P13, P15, P60-P61, P121-P124	0.7VDD		VDD	V	
	VIH2	P10-P11, P14, P16-P17, P30-P33, P120, RESET_B	0.8VDD		VDD	V	
	VIH3	P20-P24 <small>Note</small>	0.7AVREF		AVREF	V	
Input voltage, high	VIH1	P12, P13, P15, P60-P61, P121-P124	0		0.3VDD		
	VIH2	P00, P01, P10-P11, P14, P16-P17, P30-P33, P120, RESET_B	0		0.2VDD	V	
	VIH3	P20-P24 <small>Note</small>	0		0.3AVREF	V	

**Note** When used as digital input ports, set AVREF = VDD, = LVDD.

**Caution** This specification is Duty = 70% condition of IOH and IOL.

**Remark** Unless specified otherwise, the characteristics of alternate-function pins are the same as those of port pins.

## DC Characteristics (2/3)

(TA = -40 to +85°C, 1.8V < VDD = LVDD < 5.5 V, VSS = LVSS = AVSS = 0 V)

Parameter	Symbol	Conditions		MIN.	TYP.	MAX.	Unit
Output voltage, high	I <sub>OH1</sub>	I <sub>OH</sub> = -3.0 mA	P00-P01, P10-P17, P30-P33, P120	4.0 V < VDD < 5.5 V		V <sub>DD</sub> -0.7	V
		I <sub>OH</sub> = -2.5 mA		2.7 V < VDD < 4.0 V		V <sub>DD</sub> -0.5	
		I <sub>OH</sub> = -1.0 mA		1.8 V < VDD < 2.7 V		V <sub>DD</sub> -0.5	
	V <sub>OH2</sub>	I <sub>OH</sub> = -0.1 mA	P20-P24 P121-P124	1.8 V < VDD < 5.5 V AV <sub>REF</sub> = V <sub>DD</sub> = LV <sub>DD</sub>		V <sub>DD</sub> -0.5	V
Output voltage, low	V <sub>OL1</sub>	I <sub>OL</sub> = 8.5 mA	P00-P01, P10-P17, P30-P33, P120	4.0 V < VDD < 5.5		0.7	V
		I <sub>OL</sub> = 1.0 mA		2.7 V < VDD < 4.0 V		0.5	
		I <sub>OL</sub> = 0.5 mA		1.8 V < VDD < 2.7 V		0.4	
	V <sub>OL2</sub>	I <sub>OL</sub> = 0.4 mA	P20-P27* P121-P124	1.8 V < VDD < 5.5 V AV <sub>REF</sub> = V <sub>DD</sub> = LV <sub>DD</sub>		0.4	V
	V <sub>OL3</sub>	I <sub>OL</sub> = 15 mA	P00-P01, P10-P17, P30-P33, P120	4.0 V < VDD < 5.5		2.0	V
		I <sub>OL</sub> = 5.0 mA				V	
		I <sub>OL</sub> = 5.0 mA		2.7 V < VDD < 4.0 V		0.4	V
		I <sub>OL</sub> = 2.0 mA		1.8 V < VDD < 2.7 V		V	
Input leakage current, high	I <sub>LIH1</sub>	V <sub>I</sub> = V <sub>DD</sub> = LV <sub>DD</sub>	P00-P01, P10-P17, P30-P33, P120			1	μA
	I <sub>LIH2</sub>	V <sub>I</sub> = AV <sub>REF</sub>	P20-P24			1	μA
	I <sub>LIH3</sub>	V <sub>I</sub> = V <sub>DD</sub> = LV <sub>DD</sub>	X1, X2, XT1, XT2 (When use External oscillator)			1	μA
Input leakage current, low	I <sub>LIL1</sub>	V <sub>I</sub> = V <sub>SS</sub> = LV <sub>SS</sub>	P00-P01, P10-P17, P30-P33, P120			-1	μA
	I <sub>LIL2</sub>	V <sub>I</sub> = AV <sub>REF</sub>	P20-P24			-1	μA
	I <sub>LIL3</sub>	V <sub>I</sub> = V <sub>SS</sub> = LV <sub>SS</sub>	X1, X2, XT1, XT2 (When use External oscillator)			-1	μA
Pull-up resistance value	R <sub>U</sub>	V <sub>I</sub> = V <sub>DD</sub> = LV <sub>DD</sub>		10	20	100	kΩ
FLMDO supply	V <sub>IL</sub>	In normal operation mode		0		0.2V <sub>DD</sub>	V
	V <sub>IH</sub>	In flash memory programming mode		0.8V <sub>DD</sub>		V <sub>DD</sub>	V

**Remark** Unless specified otherwise, the characteristics of alternate-function pins are the same as those of port pins.

## DC Characteristics (3/3)

(TA = -40 to +85°C, 1.8V < VDD = LVDD < 5.5 V, VSS = LVSS = AVSS = 0 V)

Parameter	Symbol	Conditions	MIN.	TYP.	MAX.	Unit	
Supply current <sup>Note1</sup>	I <sub>DD1</sub>	Operation mode	f <sub>XH</sub> = 20 MHz <sup>Note2</sup> , V <sub>DD</sub> = 5.0 V		4.7	5.8	mA
			f <sub>XH</sub> = 10 MHz <sup>Note2</sup> , V <sub>DD</sub> = 5.0 V <sup>Note3</sup>		2.5	3.5	mA
			f <sub>XH</sub> = 5 MHz <sup>Note2</sup> , V <sub>DD</sub> = 3.0 V <sup>Note3</sup>		1.5	2.2	mA
			f <sub>RH</sub> = 8 MHz <sup>Note2</sup> , V <sub>DD</sub> = 5.0 V		1.9	2.7	mA
			f <sub>SUB</sub> = 32.768 kHz <sup>Note2</sup> , V <sub>DD</sub> = 5.0 V		17	T.B.D.	uA
	I <sub>DD2</sub>	HALT mod	f <sub>XH</sub> = 20 MHz <sup>Note2</sup> , V <sub>DD</sub> = 5.0 V		2.2	2.6	mA
			f <sub>XH</sub> = 10 MHz <sup>Note2</sup> , V <sub>DD</sub> = 5.0 V <sup>Note3</sup>		1.0	1.2	mA
			f <sub>XH</sub> = 5 MHz <sup>Note2</sup> , V <sub>DD</sub> = 3.0 V <sup>Note3</sup>		0.55	0.65	mA
			f <sub>RH</sub> = 8 MHz <sup>Note2</sup> , V <sub>DD</sub> = 5.0 V		0.6	0.65	mA
			f <sub>SUB</sub> = 32.768 kHz <sup>Note2</sup> , V <sub>DD</sub> = 5.0 V		3.5	T.B.D.	uA
	I <sub>DD3</sub>	STOP mode	V <sub>DD</sub> = LV <sub>DD</sub> = 5.0 V		1	20	uA
	I <sub>ADC</sub>	A/D Converter operating current	A/D converter operating		0.57	1.3	mA
			A/D converter not operating		T.B.D.	T.B.D.	mA
I <sub>WDT</sub>	Watchdog Time operating current	240 kHz Ring-OSC operating		5	10	uA	
I <sub>LVI</sub>	LVI operating current			9	T.B.D.	uA	
Supply Current of LCD	ILCD1	Only When IIC operating	VDD = 5.0 V		150	300	uA
			VDD = 3.0 V		75	150	uA
	ILCD2	Only when LCD boost function is operating	VDD = 5.0 V		2	6	uA
			VDD = 3.0 V		1.5	6	uA
	ILCD3	When LCD is operating	VDD = 5.0 V		5	15	uA
			VDD = 3.0 V		4	12	uA
	ILCD4	When LCD stopped	VDD = 5.0 V		0.1	T.B.D	uA
			VDD = 3.0 V		0.05	T.B.D	uA

### Notes

1. Total current flowing through the internal power supply (V<sub>DD</sub>).
2. Input square-wave
3. When AMPH(OSCCTL.0) = 0.

### Remark

1. f<sub>XH</sub>: High-Speed System Clock oscillation frequency (X1 clock oscillation frequency or External main system clock frequency).
2. f<sub>RH</sub>: High-speed Ring-OSC oscillation frequency.
3. f<sub>SUB</sub>: Subsystem Clock oscillation frequency (XT1 clock oscillation frequency or External subsystem clock frequency).

## AC Characteristics

### (1) Basic operation

(TA = -40 to +85°C, 1.8V < VDD = LVDD < 5.5 V, VSS = LVSS = AVSS = 0 V)

Parameter	Symbol	Conditions	MIN.	TYP.	MAX.	Unit		
Instruction cycle (minimum instruction execution time)	T <sub>cy</sub>	Main system clock(f <sub>XP</sub> ) operation	High-speed system clock(f <sub>XH</sub> )	4.0 V < VDD < 5.5 V	0.1		16	uS
				2.7 V < VDD < 4.0 V	0.2		16	uS
				1.8 V < VDD < 2.7 V	0.4		16	uS
			High-speed Ring-OSC clock(f <sub>RH</sub> )	2.7 V < VDD < 5.5 V	0.25		4	uS
				1.8 V < VDD < 2.7 V	0.5		4	uS
		Subsystem clock(f <sub>SUB</sub> )operation	114	122	125	uS		
External main system clock frequency	f <sub>EXCLK</sub>	4.0 V < VDD < 5.5 V	2.0		20.0	MHz		
		2.7 V < VDD < 4.0 V	2.0		10.0	MHz		
		1.8 V < VDD < 2.7 V	2.0		5.0	MHz		
External main system clock input high-/low-level width	t <sub>EXCLKH</sub> , t <sub>EXCLKL</sub>		(1/ f <sub>EXCLK</sub> x 1/2) - 1			nS		
External subsystem clock frequency	f <sub>EXCLKS</sub>		32	32.768	35	kHz		
External subsystem clock input high-/low-level width	t <sub>EXCLKSH</sub> , t <sub>EXCLKSL</sub>		(1/ f <sub>EXCLKS</sub> x 1/2) - 5			nS		
TI000, TI010, TI001, TI011 input high-level width, low-level width	t <sub>TIH0</sub> , t <sub>TIL0</sub>	4.0 V < VDD < 5.5 V	2/f <sub>sam</sub> + 0.1 <sup>Note1</sup>			nS		
		2.7 V < VDD < 4.0 V	2/f <sub>sam</sub> + 0.2 <sup>Note1</sup>			nS		
TI50, TI51 input frequency	f <sub>TI5</sub>	4.0 V < VDD < 5.5 V			10	MHz		
		2.7 V < VDD < 4.0 V			10	MHz		
		1.8 V < VDD < 2.7 V			5	MHz		
TI50, TI51 input high-level width, low-level width	t <sub>TIH5</sub> , t <sub>TIL5</sub>	4.0 V < VDD < 5.5 V	50			nS		
		2.7 V < VDD < 4.0 V	50			nS		
		1.8 V < VDD < 2.7 V	100			nS		
Interrupt input high-level width, low-level width	t <sub>INTH</sub> , t <sub>INTL</sub>		1			uS		
Key return input low-level Width	t <sub>KR</sub>		250			nS		
RESET low-level width	t <sub>RSL</sub>		10 <sup>Note2</sup>			uS		

### Notes

1. Selection of f<sub>sam</sub> = f<sub>PRS</sub>, f<sub>PRS</sub>/4, f<sub>PRS</sub>/256 or f<sub>PRS</sub>, f<sub>PRS</sub>/16, f<sub>PRS</sub>/64 is possible using bits 0 and 1 (PRM000, PRM001 or PRM010, PRM011) of prescaler mode register 00 and 01 (PRM00, PRM01). Note that when selecting the TI000 or TI001 valid edge as the count clock, f<sub>sam</sub> = f<sub>PRS</sub>.

2. Input low level signal into RESET pin until power supply voltage is stabilized in the case of the power supply voltage rise time is slowly (more than 3.4ms).



TCY vs VDD (main system clock operation)

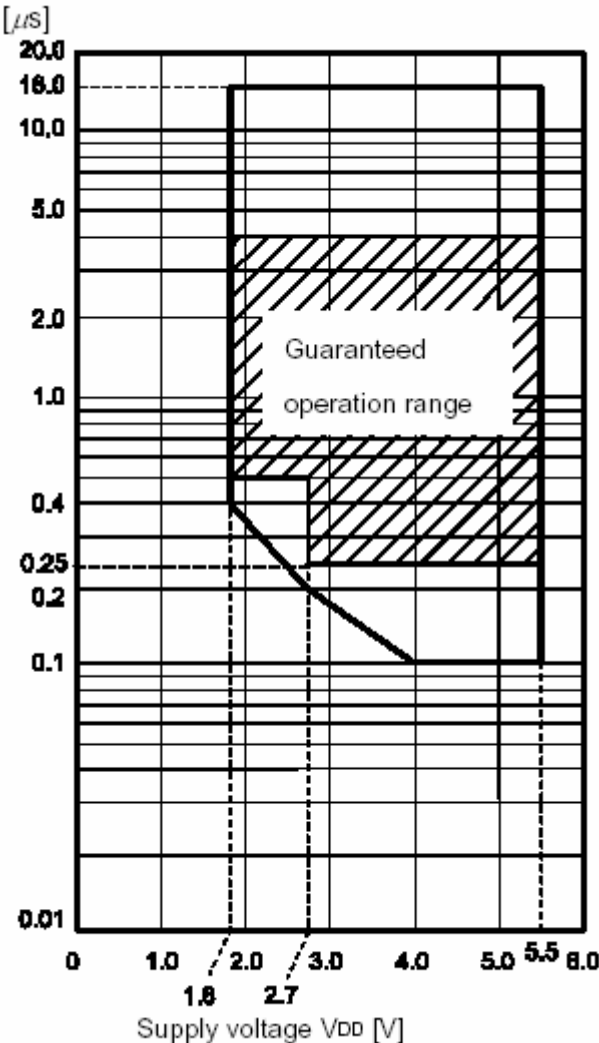

**Remark** The values indicated by the shaded section are only when the High-speed Ring-OSC clock is selected.

## AC Timing Test Points (Excluding X1 Input)

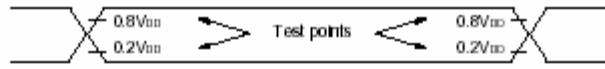

## Clock Timing

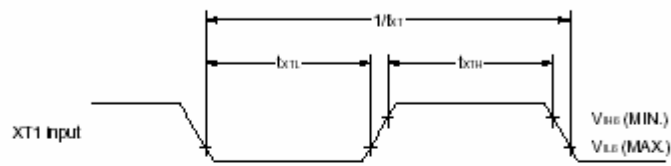
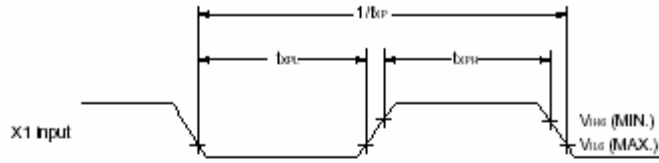

## TI Timing

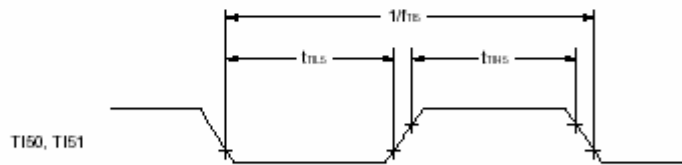
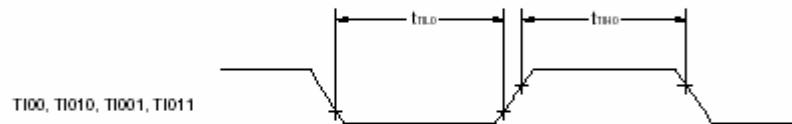

## Interrupt Request Input Timing

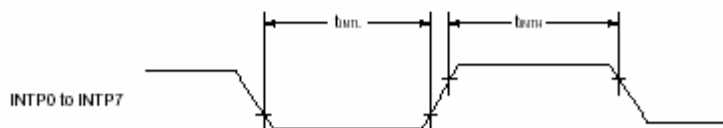

## RESET Input Timing

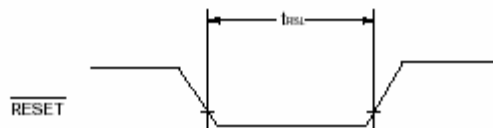

(2) Serial interface

(TA = -40 to +85°C, 1.8V < VDD = LVDD < 5.5 V, VSS = LVSS = AVSS = 0 V)

(a) UART mode (UART6, dedicated baud rate generator output)

Parameter	Symbol	Conditions	MIN.	TYP.	MAX.	Unit
Transfer rate					312.5	kbps

(b) UART mode (UART0, dedicated baud rate generator output)

Parameter	Symbol	Conditions	MIN.	TYP.	MAX.	Unit
Transfer rate					312.5	kbps

(c) IIC0 mode

Parameter	Symbol	Normal mode		High speed mode		Unit
		MIN.	MAX.	MIN.	MAX.	
SCL0 clock frequency	f <sub>CLK</sub>	0	100	0	400	kbps
Start/restart condition setup time <sup>Note1</sup>	t <sub>SU: STA</sub>	4.8		0.7		
hold time	t <sub>HD: STA</sub>	4.1		0.7		
Hold time in SCL = "L"	t <sub>LOW</sub>	5.0		1.25		
Hold time in SCL = "H"	t <sub>HIGH</sub>	5.0		1.25		
Data setup time (reception)	t <sub>SU: DAT</sub>	0		0		
Data hold time (sending) <sup>Note2</sup>	t <sub>HD: DAT</sub>	0.47	4.0	0.23	1.0	

**Notes**

1. The first clock pulse is generated after this period in the case of the start/restart condition.
2. The MAX of t<sub>HD: DAT</sub> is normal transition value. Wait is occurred in the term of ACK(acknowledge) .

**Caution Specification at 1.8 V ° V<sub>DD</sub> < 2.7V is not fixed.**

(d) 3-wire serial I/O mode (CSI10, CSI11 master mode, SCK1n···internal clock output)

Parameter	Symbol	Conditions	MIN.	TYP.	MAX.	Unit
SCK1n cycle time $t_{KCY1}$	$t_{KCY1}$	$4.0\text{ V} < V_{DD} < 5.5\text{ V}$	100			ns
		$2.7\text{ V} < V_{DD} < 4.0\text{ V}$	200			ns
		$1.8\text{ V} < V_{DD} < 2.7\text{ V}$	400			
SCK1n high-/low-level width	$t_{KH1}$ , $t_{KL1}$		$t_{KCY1}/2 - 10$ <sup>Note1</sup>			ns
SI1n setup time (to SCK1n $\uparrow$ )	$t_{SIK1}$		30			ns
SI1n hold time (to SCK1n $\uparrow$ )	$t_{KSI1}$		30			ns
Delay time from SCK1n $\downarrow$ to SO1n output	$t_{KSO1}$	$C = 50\text{ pF}$ <sup>Note2</sup>			40	ns

**Notes** 1. This is the value when the high-speed system clock ( $f_{XH}$ ) is operating.

2. C is the load capacitance of the SCK1n and SO1n output lines.

### Serial Transfer Timing 3-wire serial I/O mode:

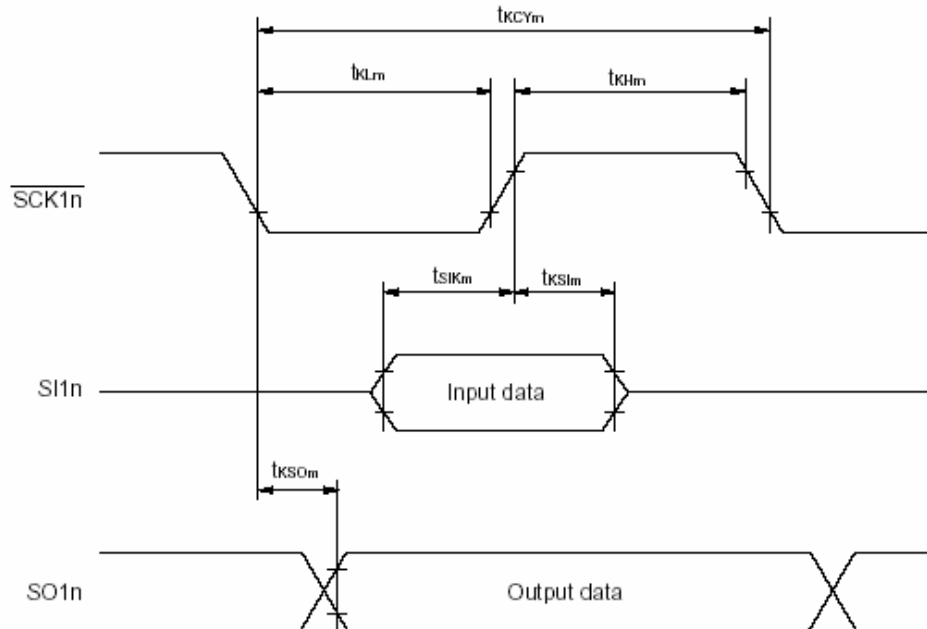

**Remark**  $m = 1, 2$   
 $n = 0, 1$

## A/D Converter Characteristics

( $T_A = -40$  to  $+85^\circ\text{C}$ ,  $2.3\text{ V} < AV_{REF} < V_{DD} = EV_{DD} < V_{DD} = LV_{DD}$ ,  $V_{SS} = LV_{SS} = AV_{SS} = 0\text{ V}$ )

Parameter	Symbol	Conditions	MIN.	TYP.	MAX.	Unit
Resolution	$R_{ES}$				10	Bit
Overall error <small>Note1,2</small>	$A_{INL}$	$4.0\text{ V} < V_{DD} < 5.5\text{ V}$			$\pm 0.4$	%FSR
		$2.7\text{ V} < V_{DD} < 4.0\text{ V}$			$\pm 0.6$	%FSR
		$AV_{REF} < 2.7\text{ V}$			T.B.D.	%FSR
Conversion time	$t_{CONV}$	$4.0\text{ V} < V_{DD} < 5.5\text{ V}$	6.6		30	$\mu\text{S}$
		$2.7\text{ V} < V_{DD} < 4.0\text{ V}$	6.6		30	$\mu\text{S}$
		$AV_{REF} < 2.7\text{ V}$	11		T.B.D.	$\mu\text{S}$
Zero-scale error <small>Note1,2</small>	$E_{ZS}$	$4.0\text{ V} < V_{DD} < 5.5\text{ V}$			$\pm 0.4$	%FSR
		$2.7\text{ V} < V_{DD} < 4.0\text{ V}$			$\pm 0.6$	%FSR
		$AV_{REF} < 2.7\text{ V}$			T.B.D.	%FSR
Full-scale error <small>Note1,2</small>	$E_{FS}$	$4.0\text{ V} < V_{DD} < 5.5\text{ V}$			$\pm 0.4$	%FSR
		$2.7\text{ V} < V_{DD} < 4.0\text{ V}$			$\pm 0.6$	%FSR
		$AV_{REF} < 2.7\text{ V}$			T.B.D.	%FSR
Integral linearity error <small>Note1,2</small>	$I_{LE}$	$4.0\text{ V} < V_{DD} < 5.5\text{ V}$			$\pm 2.5$	%FSR
		$2.7\text{ V} < V_{DD} < 4.0\text{ V}$			$\pm 4.5$	%FSR
		$AV_{REF} < 2.7\text{ V}$			T.B.D.	%FSR
Differential linearity error <small>Note1,2</small>	$D_{LE}$	$4.0\text{ V} < V_{DD} < 5.5\text{ V}$			$\pm 1.5$	%FSR
		$2.7\text{ V} < V_{DD} < 4.0\text{ V}$			$\pm 2.0$	%FSR
		$AV_{REF} < 2.7\text{ V}$			T.B.D.	%FSR
Analog input voltage	$V_{AIN}$		$AV_{SS}$		$AV_{REF}$	V

### Notes

1. Excludes quantization error ( $\pm 1/2$  LSB).
2. This value is indicated as a ratio (%FSR) to the full-scale value.

## POC Circuit Characteristics ( $T_A = -40$ to $+85^\circ\text{C}$ )

Parameter	Symbol	Conditions	MIN.	TYP.	MAX.	Unit
Detection voltage	$V_{POC}$		1.3	1.5	1.7	V
Power supply rise time	$t_{PTH}$	$V_{DD} : V_{POC} \rightarrow 1.8\text{ V}$ (MIN. value of $V_{DD}$ )		75	T.B.D.	mV/ms
Minimum pulse width	$t_{PW}$		T.B.D.	50		$\mu\text{S}$

### Notes

1. When voltage rises, time required from detection to reset release
2. When voltage drops, time required from detection to reset occur.

## POC Circuit Timing

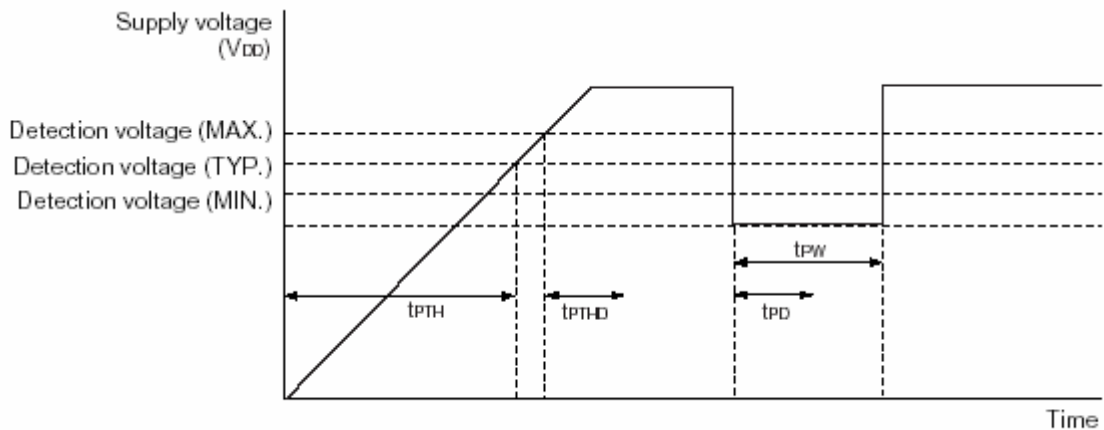

## LVI Circuit Characteristics ( $T_A = -40$ to $+85^\circ\text{C}$ )

Parameter	Symbol	Conditions	MIN.	TYP.	MAX.	Unit	
Detection voltage	Supply voltage level	V <sub>LV10</sub>		4.10	4.20	4.30	V
		V <sub>LV11</sub>		3.95	4.05	4.15	V
		V <sub>LV12</sub>		3.81	3.91	4.01	V
		V <sub>LV13</sub>		3.66	3.76	3.86	V
		V <sub>LV14</sub>		3.51	3.61	3.71	V
		V <sub>LV15</sub>		3.37	3.47	3.57	V
		V <sub>LV16</sub>		3.22	3.32	3.42	V
		V <sub>LV17</sub>		3.07	3.17	3.27	V
		V <sub>LV18</sub>		2.93	3.03	4.03	V
		V <sub>LV19</sub>		2.78	2.88	2.98	V
		V <sub>LV10</sub>		2.63	2.73	2.83	V
		V <sub>LV11</sub>		2.49	2.59	2.69	V
		V <sub>LV12</sub>		2.34	2.44	2.54	V
		V <sub>LV13</sub>		2.19	2.29	2.39	V
		V <sub>LV14</sub>		2.05	2.15	2.25	V
V <sub>LV15</sub>		1.90	2.00	2.10	V		
External input pin <sup>Note1</sup>	EXLVI	EXLVI < V <sub>DD</sub> = LV <sub>DD</sub>		1.21		V	
Minimum pulse width	t <sub>LW</sub>		T.B.D.	50		us	
Operation stabilization wait time <sup>Note2</sup>	T <sub>LWAIT1</sub>			10	T.B.D.	us	

**Note**

- Using EXLVI/P120/INTP0 pin
- Time required from setting LVION to 1 to operation stabilization

**Remark** V<sub>LV1(n-1)</sub> > V<sub>LV1n</sub>; n = 1-15

LVI Circuit Timing

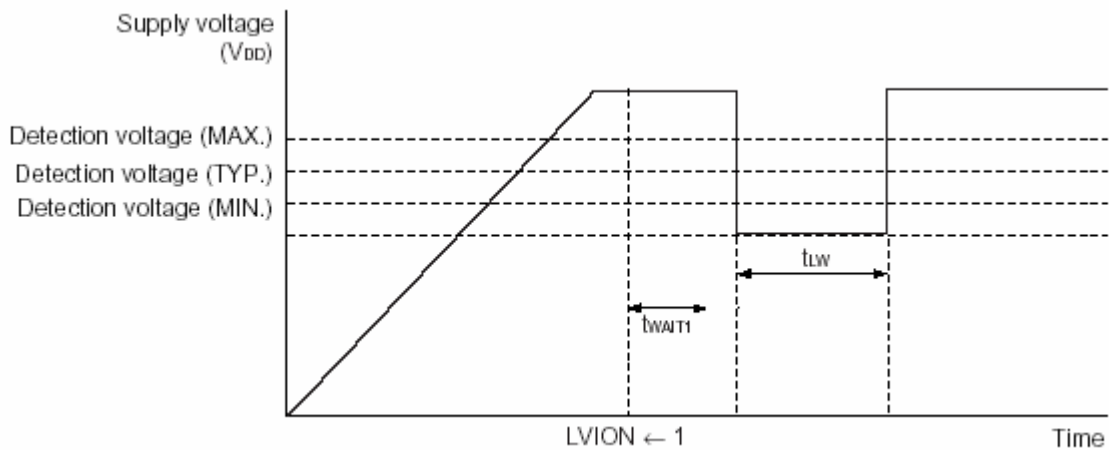

## LCD

a) LCD Ladder type( $T_A = -40$  to  $+85^{\circ}\text{C}$  ,  $2.0\text{V} < \text{LVDD} < 5.5\text{V}$ )

(1) Static

Parameter	Symbol	Conditions	MIN.	TYP.	MAX.	Unit
LCD power supply	VLCD		2.0		LVDD	V
LCD ladder resistance	RLCD		60.	100	150	k $\Omega$
LCD output Deflection(COMON)	VODC	$I_O = \pm 5\mu\text{A}$	0		$\pm 0.2$	V
LCD output Deflection(SEGMENT)	VODS	$I_O = \pm 1\mu\text{A}$	0		$\pm 0.2$	V

(2) 1/3 bias

Parameter	Symbol	Conditions	MIN.	TYP.	MAX.	Unit
LCD power supply	VLCD		2.5		LVDD	V
LCD ladder resistance	RLCD		60.	100	150	k $\Omega$
LCD output Deflection(COMON)	VODC	$I_O = \pm 5\mu\text{A}$	0		$\pm 0.2$	V
LCD output Deflection(SEGMENT)	VODS	$I_O = \pm 1\mu\text{A}$	0		$\pm 0.2$	V

(3) 1/2 bias

Parameter	Symbol	Conditions	MIN.	TYP.	MAX.	Unit
LCD power supply	VLCD		2.7		LVDD	V
LCD ladder resistance	RLCD		60.	100	150	k $\Omega$
LCD output Deflection(COMON)	VODC	$I_O = \pm 5\mu\text{A}$	0		$\pm 0.2$	V
LCD output Deflection(SEGMENT)	VODS	$I_O = \pm 1\mu\text{A}$	0		$\pm 0.2$	V

a) LCD booster type( $T_A = -40$  to  $+85^\circ\text{C}$  ,  $1.8\text{V} < \text{LVDD} < 5.5\text{V}$ )

Parameter	Symbol	Conditions		MIN.	TYP.	MAX.	Unit
LCD output voltage	VLCD2	C1-C4=0.47uF	GAIN=1	0.87	0.93	1	V
				0.94	1	1.06	V
				1	1.07	1.14	V
				1.16 <sup>Note</sup>	1.13 <sup>Note</sup>	1.2 <sup>Note</sup>	V
			GAIN=1.5	1.35	1.43	1.51	V
				1.42	1.5	1.58	V
				1.48	1.57	1.66	V
			1.54	1.63	1.72	V	
Two times voltage	VLCD1	C1-C4=0.47uF			2xVLCD2		
Three times voltage	LVCD2	C1-C4=0.47uF			3xVLCD2		
Booster wait time	tVAWAIT	GAIN=1	4.0 V < V <sub>DD</sub> < 5.5 V	4			S
			2.7 V < V <sub>DD</sub> < 4.0 V	0.5			S
		GAIN=1.5	0.5			S	
LCD output resistor (COMMON)	RODC					40	kΩ
LCD output resistor (SEGMENT)	RODS					200	kΩ

**Note 2.0V < LVDD < 5.5V**



## Data Memory STOP Mode Low Supply Voltage Data Retention Characteristics (T<sub>A</sub> = -40 to +85° C)

Parameter	Symbol	Conditions	MIN.	TYP.	MAX.	Unit
Data retention supply voltage	V <sub>DDDR</sub>		1.3 <sup>Note</sup>		5.5	V

**Note** Dependence on POC detection voltage. The data is held before POC reset, but is not held after POC reset when voltage drops.

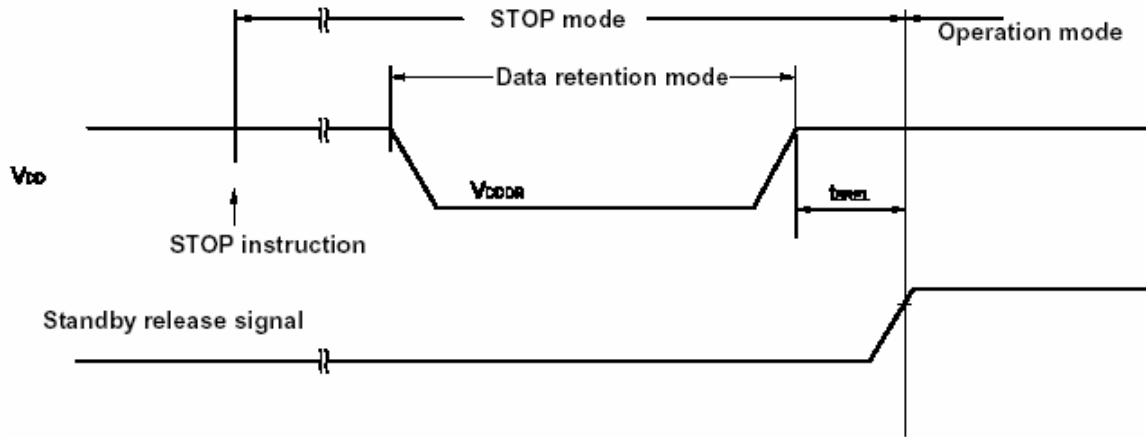

## Flash Memory Programming Characteristics

(1) Basic characteristics

(TA = -40 to +85°C, 2.7V < VDD = LVDD < 5.5 V, VSS = LVSS = AVSS = 0 V)

Parameter	Symbol	Conditions	MIN.	TYP.	MAX.	Unit
VDD supply current	I <sub>DD</sub>			4.5	11.0	mA
Erase time <sup>Note1</sup>	Chip unit	T <sub>eraca</sub>		T.B.D	T.B.D	ms
	Sector unit	T <sub>erasa</sub>		T.B.D	T.B.D	ms
Write time	T <sub>wrwa</sub>			T.B.D	T.B.D	us
Number of rewrites per chip	C <sub>erwr</sub>	1 erase + 1 write after erase = 1 rewrite <sup>Note2</sup>	T.B.D			time

### Notes

1. The prewrite time before erasure and the erase verify time (writeback time) are not included.
2. When a product is first written after shipment, "erase → write" and "write only" are both taken as one rewrite.

(2) Serial write operation characteristics

Parameter	Symbol	Conditions	MIN.	TYP.	MAX.	Unit
Time from RESET↑ to FLMD0 count start	T <sub>RFCF</sub>		4.1		17.1	ms
Count execution time	T <sub>COUNT</sub>		10.8		13.2	ms
FLMD0 counter high-/low-level width	T <sub>CH</sub> /T <sub>CL</sub>		T <sub>c</sub> x 0.45			us
FLMD0 counter rise/fall time	T <sub>R</sub> /T <sub>F</sub>		12.5			time

**Remark** These values may change after evaluation.

### Serial Write Operation

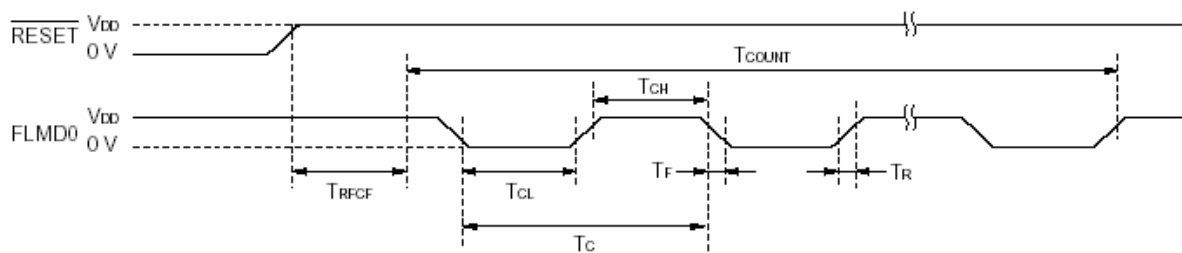

## NOTES FOR CMOS DEVICES

### 1 VOLTAGE APPLICATION WAVEFORM AT INPUT PIN

Waveform distortion due to input noise or a reflected wave may cause malfunction. If the input of the CMOS device stays in the area between VIL (MAX) and VIH (MIN) due to noise, etc., the device may malfunction. Take care to prevent chattering noise from entering the device when the input level is fixed, and also in the transition period when the input level passes through the area between VIL (MAX) and VIH (MIN).

### 2 HANDLING OF UNUSED INPUT PINS

Unconnected CMOS device inputs can be cause of malfunction. If an input pin is unconnected, it is possible that an internal input level may be generated due to noise, etc., causing malfunction. CMOS devices behave differently than Bipolar or NMOS devices. Input levels of CMOS devices must be fixed high or low by using pull-up or pull-down circuitry. Each unused pin should be connected to VDD or GND via a resistor if there is a possibility that it will be an output pin. All handling related to unused pins must be judged separately for each device and according to related specifications governing the device.

### 3 PRECAUTION AGAINST ESD

A strong electric field, when exposed to a MOS device, can cause destruction of the gate oxide and ultimately degrade the device operation. Steps must be taken to stop generation of static electricity as much as possible, and quickly dissipate it when it has occurred. Environmental control must be adequate. When it is dry, a humidifier should be used. It is recommended to avoid using insulators that easily build up static electricity. Semiconductor devices must be stored and transported in an anti-static container, static shielding bag or conductive material. All test and measurement tools including work benches and floors should be grounded. The operator should be grounded using a wrist strap. Semiconductor devices must not be touched with bare hands. Similar precautions need to be taken for PW boards with mounted semiconductor devices.

### 4 STATUS BEFORE INITIALIZATION

Power-on does not necessarily define the initial status of a MOS device. Immediately after the power source is turned ON, devices with reset functions have not yet been initialized. Hence, power-on does not guarantee output pin levels, I/O settings or contents of registers. A device is not initialized until the reset signal is received. A reset operation must be executed immediately after power-on for devices with reset functions.

### 5 POWER ON/OFF SEQUENCE

In the case of a device that uses different power supplies for the internal operation and external interface, as a rule, switch on the external power supply after switching on the internal power supply. When switching the power supply off, as a rule, switch off the external power supply and then the internal power supply. Use of the reverse power on/off sequences may result in the application of an overvoltage to the internal elements of the device, causing malfunction and degradation of internal elements due to the passage of an abnormal current.

The correct power on/off sequence must be judged separately for each device and according to related specifications governing the device.

### 6 INPUT OF SIGNAL DURING POWER OFF STATE

Do not input signals or an I/O pull-up power supply while the device is not powered. The current injection that results from input of such a signal or I/O pull-up power supply may cause malfunction and the abnormal current that passes in the device at this time may cause degradation of internal elements. Input of signals during the power off state must be judged separately for each device and according to related specifications governing the device.

Windows and Windows NT are either registered trademarks or trademarks of Microsoft Corporation in the United States and/or other countries.

PC/AT is a trademark of International Business Machines Corporation.

HP9000 series 700 and HP-UX are trademarks of Hewlett-Packard Company.

SPARCstation is a trademark of SPARC International, Inc.

Solaris and SunOS are trademarks of Sun Microsystems, Inc.

SuperFlash® is a registered trademark of Silicon Storage Technology, Inc. in several countries including the United States and Japan.