

# XC9267 Series

ETR05054-002

## 36V Operation 600mA Synchronous Step-Down DC/DC Converters

### ■ GENERAL DESCRIPTION

The XC9267 series are 36V operation synchronous step-down DC/DC converter ICs with a built-in P-channel MOS driver transistor and N-channel MOS switching transistor.

The XC9267 series has operating voltage range of 3.0V~36.0V and high-efficiency power supply up to an output current of 600mA. Low ESR capacitors such as ceramic capacitors can be used for the load capacitor ( $C_L$ ).

A 0.75V reference voltage source is incorporated in the IC, and the output voltage can be set to a value from 1.0V to 25.0V using external resistors ( $R_{FB1}$ ,  $R_{FB2}$ ).

1.2MHz or 2.2MHz can be selected for the switching frequency.

The soft-start time is internally set to 2.0ms (TYP.), but can be adjusted to set a longer time using an external resistor and capacitor. With the built-in UVLO function, the driver transistor is forced OFF when input voltage becomes 2.7V or lower.

The output state can be monitored using the power good function.

Internal protection circuits include over current protection and thermal shutdown circuits to enable safe use.

### ■ APPLICATIONS

- Electric Meter
- Gas Detector
- Various Sensor
- Industrial Equipment
- Home appliance

### ■ FEATURES

|                               |   |   |
|-------------------------------|---|---|
| Input Voltage Range           | : | 3.0 ~ 36V (Absolute Max 40V)              |
| Output Voltage Range          | : | 1.0 ~ 25V                                 |
| FB Voltage                    | : | 0.75V $\pm$ 1.5%                          |
| Oscillation Frequency         | : | 1.2MHz, 2.2MHz                            |
| Output Current                | : | 600mA                                     |
| Control Methods               | : | PWM control                               |
|                               |   | Efficiency88%@12V $\rightarrow$ 5V, 300mA |
| Soft-start Time               | : | Adjustable by RC                          |
| Protection Circuits           | : | Over Current Protection                   |
|                               |   | Thermal Shutdown                          |
| Output Capacitor              | : | Ceramic Capacitor                         |
| Operating Ambient Temperature | : | -40 $^{\circ}$ C ~ +105 $^{\circ}$ C      |
| Packages                      | : | SOT-89-5 (Without Power Good)             |
|                               |   | USP-6C (With Power Good)                  |
| Environmentally Friendly      | : | EU RoHS Compliant, Pb Free                |

### ■ TYPICAL APPLICATION CIRCUIT

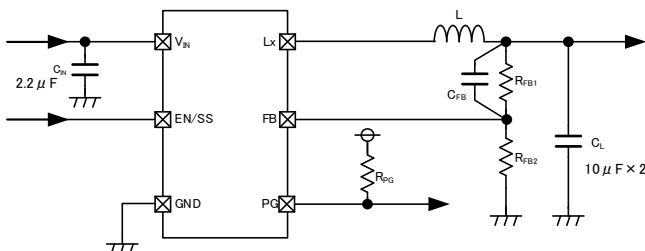

### ■ TYPICAL PERFORMANCE CHARACTERISTICS

XC9267B75Cxx  
( $V_{IN}=12V$ ,  $V_{OUT}=5V$ ,  $f_{OSC}=1.2MHz$ )

$L=6.8\mu H$ (CLF5030NIT-6R8),  $C_{IN}=4.7\mu F \times 2$ (C2012X6S1H475K)  
 $C_L=10\mu F \times 2$ (C3216X7R1E106K)

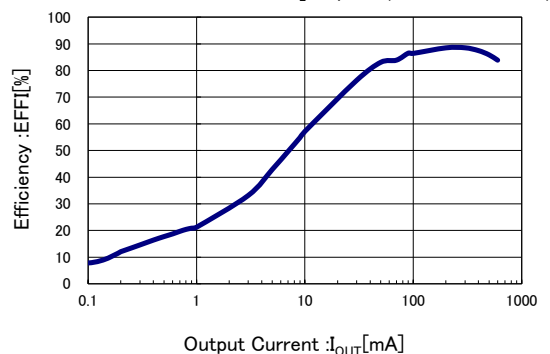

## ■ BLOCK DIAGRAM

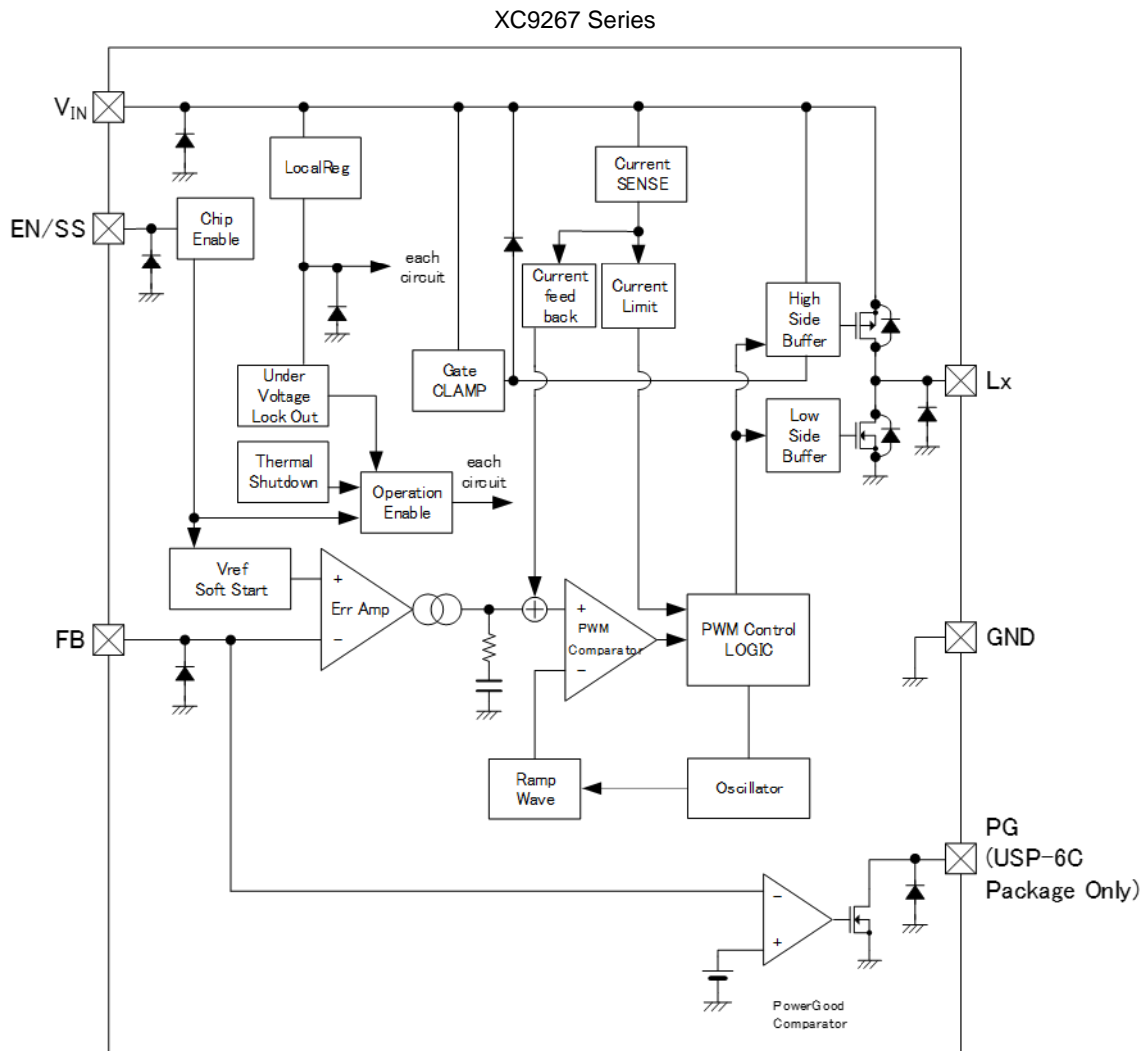

Diodes inside the circuit are an ESD protection diodes and a parasitic diodes.

## ■ PRODUCT CLASSIFICATION

### ● Ordering Information

XC9267①②③④⑤⑥-⑦<sup>(\*)</sup> PWM control

| DESIGNATOR | ITEM                  | SYMBOL              | DESCRIPTION              |
|------------|-----------------------|---------------------|--------------------------|
| ①          | Type                  | B                   | Refer to Selection Guide |
| ②③         | FB Voltage            | 75                  | 0.75V                    |
| ④          | Oscillation Frequency | C                   | 1.2MHz                   |
|            |                       | D                   | 2.2MHz                   |
| ⑤⑥-⑦       | Packages              | PR-G <sup>(*)</sup> | SOT-89-5 (1,000pcs/Reel) |
|            |                       | ER-G <sup>(*)</sup> | USP-6C (3,000pcs/Reel)   |

<sup>(\*)</sup> The "-G" suffix denotes Halogen and Antimony free as well as being fully RoHS compliant.

### ● Selection Guide

| FUNCTION                                | B TYPE   |        |
|---|----------|--------|
|   | SOT-89-5 | USP-6C |
| Chip Enable                             | Yes      | Yes    |
| UVLO                                    | Yes      | Yes    |
| Thermal Shutdown                        | Yes      | Yes    |
| Soft Start                              | Yes      | Yes    |
| Power-Good                              | -        | Yes    |
| Current Limiter<br>(Automatic Recovery) | Yes      | Yes    |

## PIN CONFIGURATION

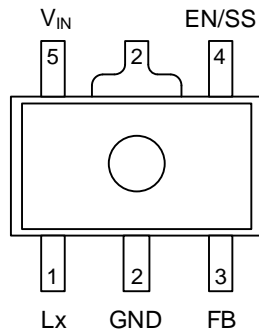

SOT-89-5  
(TOP VIEW)

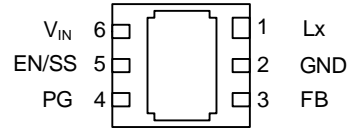

USP-6C  
(BOTTOM VIEW)

\* The dissipation pad for the USP-6C package should be solder-plated in recommended mount pattern and metal masking so as to enhance mounting strength and heat release. If the pad needs to be connected to other pins, it should be connected to the GND (No. 2) pin.

## PIN ASSIGNMENT

| PIN NUMBER |        | PIN NAME        | FUNCTION             |
|------------|--------|-----------------|----------------------|
| SOT-89-5   | USP-6C |                 |                      |
| 1          | 1      | Lx              | Switching Output     |
| 2          | 2      | GND             | Ground               |
| 3          | 3      | FB              | Output Voltage Sense |
| -          | 4      | PG              | Power-good Output    |
| 4          | 5      | EN/SS           | Enable Soft-start    |
| 5          | 6      | V <sub>IN</sub> | Power Input          |

## ■ FUNCTION CHART

| PIN NAME | SIGNAL | STATUS                         |
|----------|--------|--------------------------------|
| EN/SS    | L      | Stand-by                       |
|          | H      | Active                         |
|          | OPEN   | Undefined State <sup>(*)</sup> |

<sup>(\*)</sup> Please do not leave the EN/SS pin open. Each should have a certain voltage

| PIN NAME | CONDITION | SIGNAL                           |                    |
|----------|-----------|----------------------------------|--------------------|
| PG       | EN/SS = H | $V_{FB} > V_{PGDET}$             | H (High impedance) |
|          |           | $V_{FB} \leq V_{PGDET}$          | L (Low impedance)  |
|          |           | Thermal Shutdown                 | L (Low impedance)  |
|          |           | UVLO<br>( $V_{IN} < V_{UVLO1}$ ) | Undefined State    |
|          | EN/SS = L | Stand-by                         | L (Low impedance)  |

## ■ ABSOLUTE MAXIMUM RATINGS

Ta=25°C

| PARAMETER                     | SYMBOL             | RATINGS  | UNITS                                |
|-------------------------------|--------------------|--|--------------------------------------|
| V <sub>IN</sub> Pin Voltage   | V <sub>IN</sub>    | -0.3 ~ +40   | V                                    |
| EN/SS Pin Voltage             | V <sub>EN/SS</sub> | -0.3 ~ +40   | V                                    |
| FB Pin Voltage                | V <sub>FB</sub>    | -0.3 ~ +6.2  | V                                    |
| PG Pin Voltage <sup>(*)</sup> | V <sub>PG</sub>    | -0.3 ~ +6.2  | V                                    |
| PG Pin Current <sup>(*)</sup> | I <sub>PG</sub>    | 8  | mA                                   |
| Lx Pin Voltage                | V <sub>Lx</sub>    | -0.3 ~ V <sub>IN</sub> + 0.3 or +40 <sup>(*)</sup> | V                                    |
| Lx Pin Current                | I <sub>Lx</sub>    | 1800   | mA                                   |
| Power Dissipation             | SOT-89-5           | Pd   | 1750 (JESD51-7 board) <sup>(*)</sup> |
|                               | USP-6C(DAF)        |  | 1250 (JESD51-7 board) <sup>(*)</sup> |
| Surge Voltage                 | V <sub>SURGE</sub> | +46 <sup>(*)</sup>                                 | V                                    |
| Operating Ambient Temperature | T <sub>opr</sub>   | -40 ~ +105   | °C                                   |
| Storage Temperature           | T <sub>stg</sub>   | -55 ~ +125   | °C                                   |

\* All voltages are described based on the GND pin.

<sup>(\*)</sup> For the USP-6C Package only.

<sup>(2)</sup> The maximum value should be either V<sub>IN</sub>+0.3 or 40 in the lowest.

<sup>(3)</sup> Applied Time ≤ 400ms

<sup>(4)</sup> The power dissipation figure shown is PCB mounted and is for reference only.

The mounting condition is please refer to PACKAGING INFORMATION.

## ELECTRICAL CHARACTERISTICS

XC9267series

Ta=25°C

| PARAMETER                                    | SYMBOL   | CONDITIONS  | MIN.       | TYP.         | MAX.  | UNIT   | CIRCUIT |   |
|--|--|---|------------|--------------|-------|--------|---------|---|
| FB Voltage                                   | V <sub>FB</sub> E                                      | V <sub>FB</sub> =0.739V→0.761V,<br>V <sub>FB</sub> Voltage when Lx pin voltage<br>changes from "H" level to "L" level   | 0.739      | 0.750        | 0.761 | V      | ②       |   |
| Setting Output<br>Voltage Range (*1)         | V <sub>OUTSET</sub>                                    | -   | 1          | -            | 25    | V      | -       |   |
| Operating Input<br>Voltage Range (*1)        | V <sub>IN</sub>  | -   | 3          | -            | 36    | V      | -       |   |
| UVLO Detect Voltage                          | V <sub>UVLOD</sub>                                     | V <sub>EN/SS</sub> =12V, V <sub>IN</sub> :2.8V→2.6V, V <sub>FB</sub> =0V<br>V <sub>IN</sub> Voltage which Lx pin voltage<br>holding "H" level                 | 2.6        | 2.7          | 2.8   | V      | ②       |   |
| UVLO Release Voltage                         | V <sub>UVLOR</sub>                                     | V <sub>EN/SS</sub> =12V, V <sub>IN</sub> :2.7V→2.9V, V <sub>FB</sub> =0V<br>V <sub>IN</sub> Voltage which Lx pin voltage<br>holding "L" level                 | 2.7        | 2.8          | 2.9   | V      | ②       |   |
| Quiescent Current                            | I <sub>q</sub>   | V <sub>FB</sub> =0.825V   | XC9267B75C | -            | 180   | 350    | μA      | ④ |
|  |  |   | XC9267B75D | -            | 290   | 500    |         |   |
| Stand-by Current                             | I <sub>STBY</sub>                                      | V <sub>IN</sub> =12V, V <sub>EN/SS</sub> =V <sub>FB</sub> =0V   | -          | 1.65         | 2.50  | μA     | ④       |   |
| Oscillation Frequency                        | f <sub>OSC</sub>                                       | Connected to<br>external<br>components,<br>I <sub>OUT</sub> =200mA  | XC9267B75C | 1.098        | 1.200 | 1.302  | MHz     | ① |
|  |  |   | XC9267B75D | 2.013        | 2.200 | 2.387  |         |   |
| Minimum On Time                              | t <sub>ONMIN</sub>                                     | Connected to external components  | -          | 85 (*2)      | -     | ns     | ①       |   |
| Minimum Duty Cycle                           | D <sub>MIN</sub>                                       | V <sub>FB</sub> =0.825V   | -          | -            | 0     | %      | ②       |   |
| Maximum Duty Cycle                           | D <sub>MAX</sub>                                       | V <sub>FB</sub> =0.675V   | 100        | -            | -     | %      | ②       |   |
| Lx SW "H" On Resistance                      | R <sub>LxH</sub>                                       | V <sub>FB</sub> =0.675V, I <sub>Lx</sub> =200mA   | -          | 1.20         | 1.38  | Ω      | ⑤       |   |
| Lx SW "L" On Resistance                      | R <sub>LxL</sub>                                       |   | -          | 0.60<br>(*2) | -     | Ω      | ⑤       |   |
| Highside Current Limit (*3)                  | I <sub>LIMH</sub>                                      | V <sub>FB</sub> =V <sub>FB</sub> E×0.98   | 1.00       | 1.30         | -     | A      | ⑤       |   |
| Internal Soft-Start Time                     | t <sub>SS1</sub>                                       | V <sub>FB</sub> =0.675V   | 1.6        | 2.0          | 2.4   | ms     | ②       |   |
| External Soft-Start Time                     | t <sub>SS2</sub>                                       | V <sub>FB</sub> =0.675V<br>R <sub>SS</sub> =430KΩ, C <sub>SS</sub> =0.47μF  | 21         | 26           | 33    | ms     | ③       |   |
| PG detect voltage (*4)                       | V <sub>PGDET</sub>                                     | V <sub>FB</sub> =0.712V→0.638V, R <sub>PG</sub> :100kΩ<br>pull-up to 5V<br>V <sub>FB</sub> Voltage when PG pin voltage<br>changes from "H" level to "L" level | 0.638      | 0.675        | 0.712 | V      | ⑤       |   |
| PG Output voltage (*4)                       | V <sub>PG</sub>  | V <sub>FB</sub> =0.6V, I <sub>PG</sub> =1mA   | -          | -            | 0.3   | V      | ②       |   |
| Efficiency (*5)                              | EFFI   | Connected to external components,<br>V <sub>IN</sub> =12V, V <sub>OUT</sub> =5V, I <sub>OUT</sub> =300mA  | -          | 88           | -     | %      | ①       |   |
| FB Voltage<br>Temperature<br>Characteristics | $\frac{\Delta V_{FB}}{(\Delta T_{opr} \cdot V_{FB}E)}$ | -40°C ≤ T <sub>opr</sub> ≤ 105°C  | -          | ±100         | -     | ppm/°C | ②       |   |

Test Condition: Unless otherwise stated, V<sub>IN</sub>=12V, V<sub>EN/SS</sub>=12V, V<sub>PG</sub>: OPEN (\*4)

Peripheral parts connection conditions :

L=6.8μH, R<sub>FB1</sub>=680kΩ, R<sub>FB2</sub>=120kΩ, C<sub>FB</sub>=18pF, C<sub>L</sub>=10μF×2parallel, C<sub>IN</sub>=2.2μF

(\*1) Please use within the range of V<sub>OUT</sub>/V<sub>IN</sub> ≥ t<sub>ONMIN</sub>[ns]×f<sub>OSC</sub>[MHz]×10<sup>-3</sup>

(\*2) Design reference value. This parameter is provided only for reference.

(\*3) Current limit denotes the level of detection at peak of coil current.

(\*4) For the USP-6C Package only.

(\*5) EFFI = {(output voltage) x (output current)} / {(input voltage) x (input current)} x 100

## ■ ELECTRICAL CHARACTERISTICS(Continued)

XC9267 series

Ta=25°C

| PARAMETER                    | SYMBOL              | CONDITIONS  | MIN. | TYP. | MAX. | UNIT | CIRCUIT |
|------------------------------|---------------------|---|------|------|------|------|---------|
| FB "H" Current               | I <sub>FBH</sub>    | V <sub>IN</sub> =V <sub>EN/SS</sub> =36V, V <sub>FB</sub> =3.0V   | -0.1 | -    | 0.1  | μA   | ④       |
| FB "L" Current               | I <sub>FBL</sub>    | V <sub>IN</sub> =V <sub>EN/SS</sub> =36V, V <sub>FB</sub> =0V   | -0.1 | -    | 0.1  | μA   | ④       |
| EN/SS "H" Voltage            | V <sub>EN/SSH</sub> | V <sub>EN/SS</sub> =0.3V→2.5V, V <sub>FB</sub> =0.71V<br>V <sub>EN/SS</sub> Voltage when Lx pin voltage changes from "L" level to "H" level | 2.5  | -    | 36   | V    | ②       |
| EN/SS "L" Voltage            | V <sub>EN/SSL</sub> | V <sub>EN/SS</sub> =2.5V→0.3V, V <sub>FB</sub> =0.71V<br>V <sub>EN/SS</sub> Voltage when Lx pin voltage changes from "H" level to "L" level | -    | -    | 0.3  | V    | ②       |
| EN/SS "H" Current            | I <sub>EN/SSH</sub> | V <sub>IN</sub> =V <sub>EN/SS</sub> =36V, V <sub>FB</sub> =0.825V   | -    | 0.1  | 0.3  | μA   | ④       |
| EN/SS "L" Current            | I <sub>EN/SSL</sub> | V <sub>IN</sub> =36V, V <sub>EN/SS</sub> =0V, V <sub>FB</sub> =0.825V   | -0.1 | -    | 0.1  | μA   | ④       |
| Thermal Shutdown Temperature | T <sub>TSD</sub>    | Junction Temperature  | -    | 150  | -    | °C   | -       |
| Hysteresis Width             | T <sub>HYS</sub>    | Junction Temperature  | -    | 25   | -    | °C   | -       |

Test Condition: Unless otherwise stated, V<sub>IN</sub>=12V, V<sub>EN/SS</sub>=12V, V<sub>PG</sub>:OPEN (\*4)

(\*4) For the USP-6C Package only.

## TEST CIRCUITS

CIRCUIT①

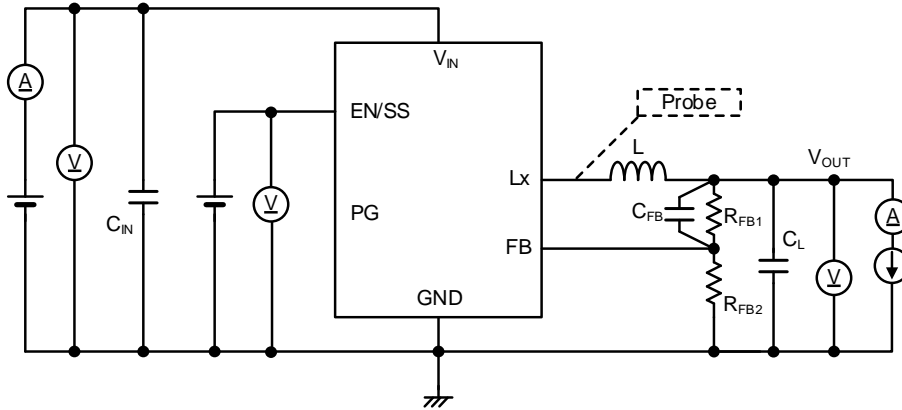

CIRCUIT②

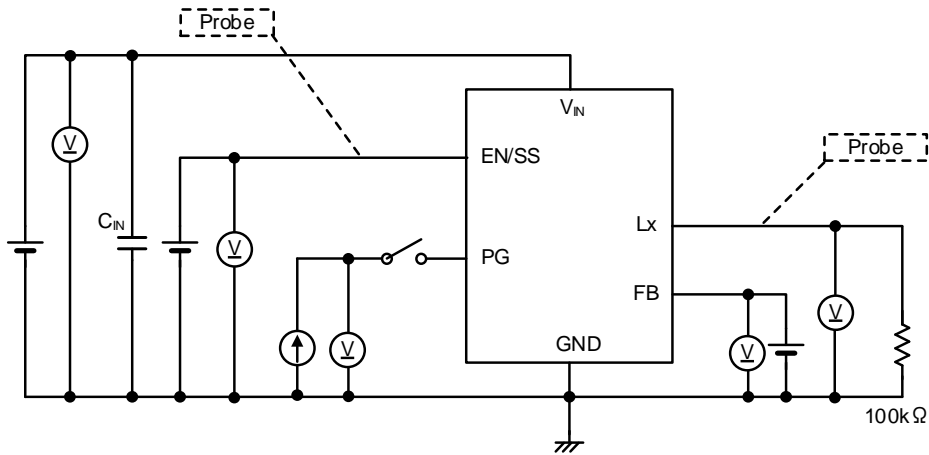

CIRCUIT③

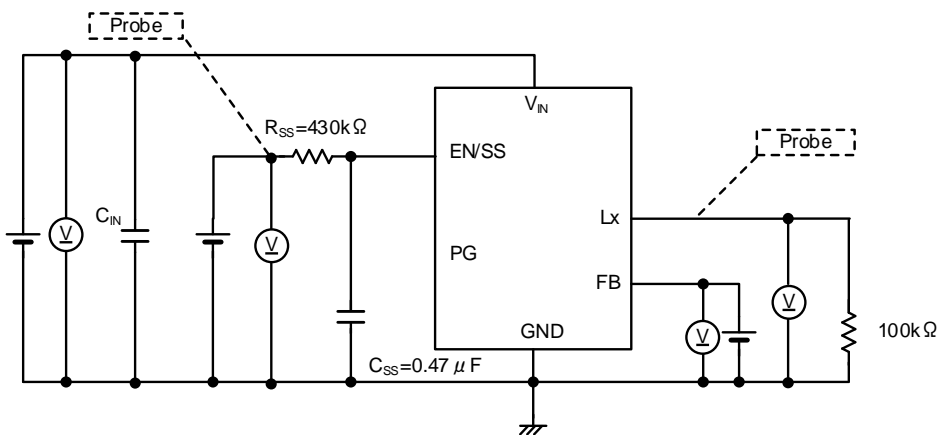

\* PG Pin is USP-6C Package only.



■ TEST CIRCUITS(Continued)

CIRCUIT④

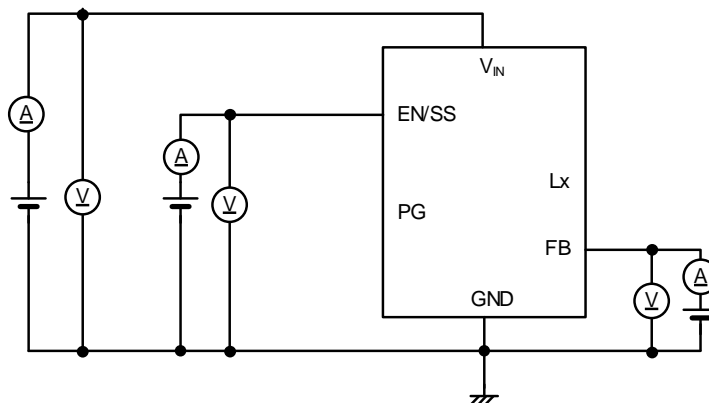

CIRCUIT⑤

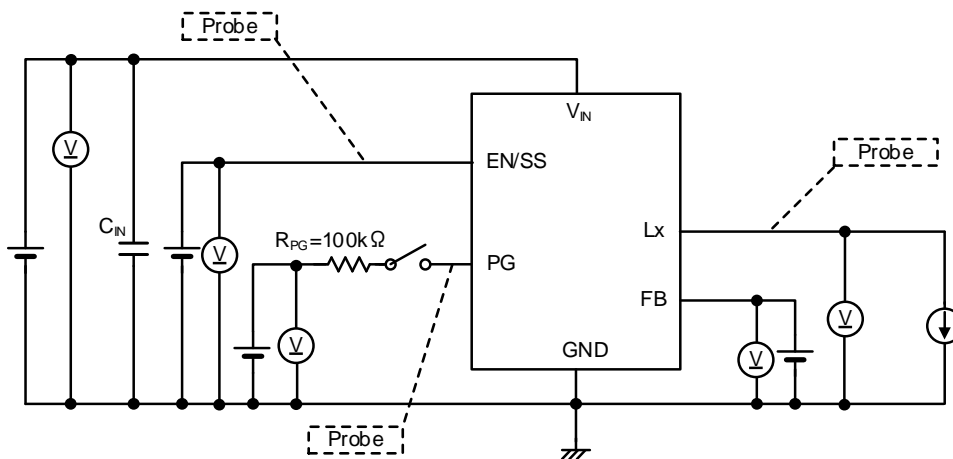

\* PG Pin is USP-6C Package only.

## TYPICAL APPLICATION CIRCUIT

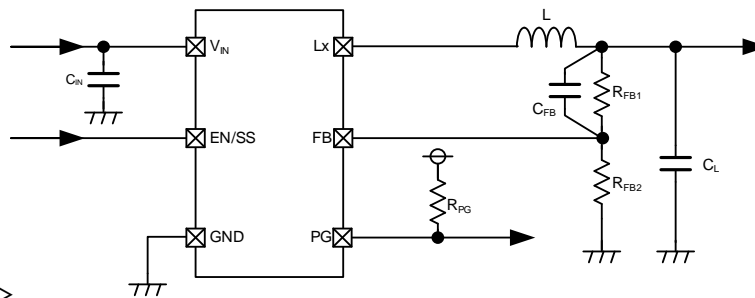

<Inductance value setting>

For the XC9267 Series, operation is optimized by setting the following inductance value according to the set frequency and setting output voltage.

f<sub>OSCSET</sub>: Frequency setting , V<sub>OUTSET</sub>: Output voltage setting

【Typical Examples】

| f <sub>OSCSET</sub>             | conditions                      | MANUFACTURER          | PRODUCT NUMBER                | VALUE               |                     |
|---------------------------------|---------------------------------|-----------------------|-------------------------------|---------------------|---------------------|
| L                               | 1V < V <sub>OUTSET</sub> ≤ 2V   | TDK                   | CLF5030NIT-3R3N               | 3.3μH               |                     |
|                                 |                                 | Coilcraft             | XEL4030-332ME                 |                     |                     |
|                                 |                                 | Taiyo Yuden           | NRS4018T3R3MDGJ               |                     |                     |
|                                 |                                 | Tokyo Coil            | SHP0420P-F3R3NAP              |                     |                     |
|                                 | 2V < V <sub>OUTSET</sub> ≤ 3.3V | TDK                   | CLF5030NIT-4R7N               | 4.7μH               |                     |
|                                 |                                 | Coilcraft             | XEL4030-472ME                 |                     |                     |
|                                 |                                 | Taiyo Yuden           | NRS5024T4R7MMGJ               |                     |                     |
|                                 |                                 | Tokyo Coil            | SHP0530P-F4R7AP               |                     |                     |
|                                 | 3.3V < V <sub>OUTSET</sub> ≤ 6V | TDK                   | CLF5030NIT-6R8N               | 6.8μH               |                     |
|                                 |                                 | Coilcraft             | XEL4030-682ME                 |                     |                     |
|                                 |                                 | Taiyo Yuden           | NRS5024T6R8MMGJ               |                     |                     |
|                                 |                                 | Tokyo Coil            | SHP0530P-F6R8AP               |                     |                     |
|                                 | 6V < V <sub>OUTSET</sub> ≤ 25V  | TDK                   | CLF5030NIT-100N               | 10μH                |                     |
|                                 |                                 | Taiyo Yuden           | NRS5040T100MMGJ               |                     |                     |
|                                 |                                 | Tokyo Coil            | SHP0530P-F100AP               |                     |                     |
|                                 |                                 | 2.2MHz                | 1V < V <sub>OUTSET</sub> ≤ 2V |                     | TDK                 |
|                                 | Coilcraft                       |                       |                               | XEL4030-152ME       |                     |
|                                 | Taiyo Yuden                     |                       |                               | NRS4018T1R5NDGJ     |                     |
|                                 | Tokyo Coil                      |                       |                               | SHP0420P-F1R6NAP    |                     |
|                                 | 2V < V <sub>OUTSET</sub> ≤ 3.3V |                       | TDK                           | CLF5030NIT-2R2N     | 2.2μH               |
| Coilcraft                       |                                 |                       | XEL4030-222ME                 |                     |                     |
| Taiyo Yuden                     |                                 |                       | NRS4018T2R2MDGJ               |                     |                     |
| Tokyo Coil                      |                                 |                       | SHP0420P-F2R2NAP              |                     |                     |
| 3.3V < V <sub>OUTSET</sub> ≤ 6V | TDK                             |                       | CLF5030NIT-3R3N               | 3.3μH               |                     |
|                                 | Coilcraft                       |                       | XEL4030-332ME                 |                     |                     |
|                                 | Taiyo Yuden                     |                       | NRS4018T3R3MDGJ               |                     |                     |
|                                 | Tokyo Coil                      |                       | SHP0420P-F3R3NAP              |                     |                     |
| 6V < V <sub>OUTSET</sub> ≤ 25V  | TDK                             | CLF5030NIT-4R7N       | 4.7μH                         |                     |                     |
|                                 | Coilcraft                       | XEL4030-472ME         |                               |                     |                     |
|                                 | Taiyo Yuden                     | NRS5024T4R7MMGJ       |                               |                     |                     |
|                                 | Tokyo Coil                      | SHP0530P-F4R7AP       |                               |                     |                     |
| C <sub>IN</sub>                 | 1.2MHz                          | V <sub>IN</sub> < 20V | TDK                           | C2012X6S1H475K125AC | 4.7μF/50V           |
|                                 |                                 | V <sub>IN</sub> ≥ 20V | TDK                           | C2012X6S1H475K125AC | 4.7μF/50V 2parallel |
|                                 | 2.2MHz                          | V <sub>IN</sub> < 20V | TDK                           | C2012X7R1H225K125AC | 2.2μF/50V           |
|                                 |                                 | V <sub>IN</sub> ≥ 20V | TDK                           | C2012X7R1H225K125AC | 2.2μF/50V 2parallel |
| C <sub>L</sub>                  | -                               | -                     | TDK                           | C2012X7R1A106K125AC | 10μF/10V 2parallel  |
|                                 |                                 |                       | TDK                           | C3216X7R1E106K160AB | 10μF/25V 2parallel  |
|                                 |                                 |                       | TDK                           | C3225X7R1H106M250AC | 10μF/50V 2parallel  |

## ■ TYPICAL APPLICATION CIRCUIT(Continued)

### < Output voltage setting >

The output voltage can be set by adding an external dividing resistor.

The output voltage is determined by the equation below based on the values of  $R_{FB1}$  and  $R_{FB2}$ .

$$V_{OUT} = 0.75V \times (R_{FB1} + R_{FB2}) / R_{FB2}$$

With  $R_{FB2} \leq 200k\Omega$  and  $R_{FB1} + R_{FB2} \leq 1M\Omega$

### < $C_{FB}$ setting >

Adjust the value of the phase compensation speed-up capacitor  $C_{FB}$  using the equation below.

$$C_{FB} = \frac{1}{2\pi \times f_{zfb} \times R_{FB1}}$$

A target value for  $f_{zfb}$  of about  $f_{zfb} = \frac{1}{2\pi \sqrt{C_L \times L}}$  is optimum.

### 【Setting Example】

To set output voltage to 5V with  $f_{osc} = 1.2MHz$ ,  $C_L = 10\mu F \times 2$ ,  $L = 6.8\mu H$

When  $R_{FB1} = 680k\Omega$ ,  $R_{FB2} = 120k\Omega$ ,  $V_{OUTSET} = 0.75V \times (680k\Omega + 120k\Omega) / 120k\Omega = 5.0V$

And  $f_{zfb}$  is set to a target of 13.65 kHz using the above equation,

$C_{FB} = 1 / (2 \times \pi \times 13.65 \text{ kHz} \times 680k\Omega) = 17.15pF$ . A capacitor of E24 series is 18pF.

| XC9267B75Cxx / $f_{osc} = 1.2MHz$ |               |               |             |          |           |
|-----------------------------------|---------------|---------------|-------------|----------|-----------|
| $V_{OUTSET}$                      | $R_{FB1}$     | $R_{FB2}$     | L           | $C_{FB}$ | $f_{zfb}$ |
| 1.2V                              | 120k $\Omega$ | 200k $\Omega$ | 3.3 $\mu H$ | 68pF     | 19.6kHz   |
| 3.3V                              | 510k $\Omega$ | 150k $\Omega$ | 4.7 $\mu H$ | 18pF     | 16.4kHz   |
| 5.0V                              | 680k $\Omega$ | 120k $\Omega$ | 6.8 $\mu H$ | 18pF     | 13.7kHz   |
| 12V                               | 360k $\Omega$ | 24k $\Omega$  | 10 $\mu H$  | 39pF     | 11.3kHz   |

| XC9267B75Dxx / $f_{osc} = 2.2MHz$ |               |               |             |          |           |
|-----------------------------------|---------------|---------------|-------------|----------|-----------|
| $V_{OUTSET}$                      | $R_{FB1}$     | $R_{FB2}$     | L           | $C_{FB}$ | $f_{zfb}$ |
| 1.2V                              | 120k $\Omega$ | 200k $\Omega$ | 1.5 $\mu H$ | 47pF     | 29.1kHz   |
| 3.3V                              | 510k $\Omega$ | 150k $\Omega$ | 2.2 $\mu H$ | 12pF     | 24.0kHz   |
| 5.0V                              | 680k $\Omega$ | 120k $\Omega$ | 3.3 $\mu H$ | 12pF     | 19.6kHz   |
| 12V                               | 360k $\Omega$ | 24k $\Omega$  | 4.7 $\mu H$ | 27pF     | 16.4kHz   |

### < Soft-start Time Setting >

The soft-start time can be adjusted by adding a capacitor and a resistor to the EN/SS pin.

Soft-start time ( $t_{SS2}$ ) is approximated by the equation below according to values of  $V_{EN/SS}$ ,  $R_{SS}$ , and  $C_{SS}$ .

$$t_{SS2} = C_{SS} \times R_{SS} \times \ln ( V_{EN/SS} / (V_{EN/SS} - 1.45) )$$

### 【Setting Example】

When  $C_{SS} = 0.47\mu F$ ,  $R_{SS} = 430k\Omega$  and  $V_{EN/SS} = 12V$ ,  $t_{SS2} = 0.47 \times 10^{-6} \times 430 \times 10^3 \times (\ln (12 / (12 - 1.45))) = 26ms$  (Approx.)

\*The soft-start time is the time from the start of  $V_{EN/SS}$  until the output voltage reaches 90% of the set voltage.

If the EN/SS pin voltage rises steeply without connecting  $C_{SS}$  and  $R_{SS}$  ( $R_{SS} = 0\Omega$ ), Output rises with taking the soft-start time of  $t_{SS1} = 2.0ms$  (TYP.) which is fixed internally.

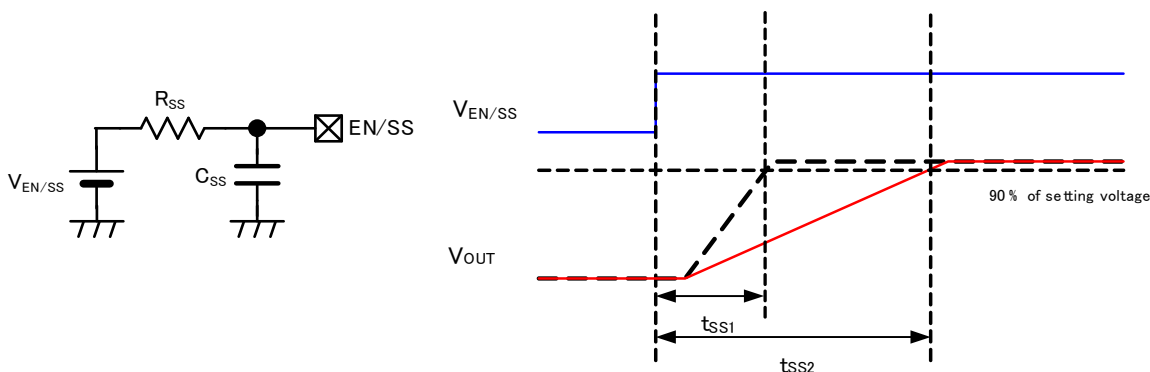

## OPERATIONAL EXPLANATION

The XC9267 series consists internally of a reference voltage supply with soft-start function, error amp, PWM comparator, ramp wave circuit, oscillator circuit, phase compensation (Current feedback) circuit, current limiting circuit, current limit PFM circuit, High-side driver Tr., Low-side driver Tr., buffer drive circuit, internal power supply (LocalReg) circuit, under-voltage lockout (UVLO) circuit, gate clamp (CLAMP) circuit, thermal shutdown (TSD) circuit, power good comparator, PWM control block and other elements.

The voltage feedback from the FB pin is compared to the internal reference voltage by the error amp, the output from the error amp is phase compensated, and the signal is input to the PWM comparator to determine the ON time of switching during PWM operation. The output signal from the error amp is compared to the ramp wave by the PWM comparator, and the output is sent to the buffer drive circuit and output from the LX pin as the duty width of switching. This operation is performed continuously to stabilize the output voltage.

The driver transistor current is monitored at each switching by the phase compensation (Current feedback) circuit, and the output signal from the error amp is modulated as a multi-feedback signal. This allows a stable feedback system to be obtained even when a low ESR capacitor such as a ceramic capacitor is used, and this stabilizes the output voltage.

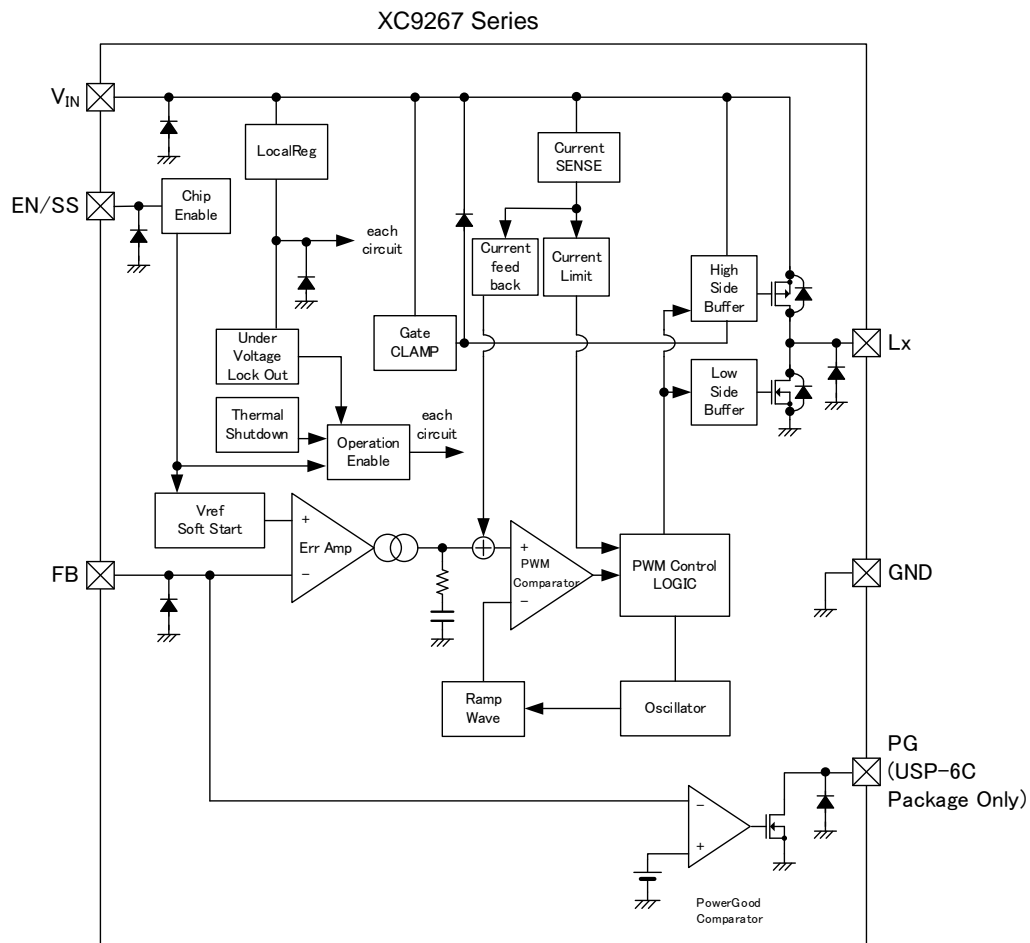

\* Diodes inside the circuits are ESD protection diodes and parasitic diodes.

### <Reference voltage source>

The reference voltage source provides the reference voltage to ensure stable output voltage of the DC/DC converter.

### <Oscillator circuit>

The oscillator circuit determines switching frequency. 1.2MHz or 2.2MHz is available for the switching frequency. Clock pulses generated in this circuit are used to produce ramp waveforms needed for PWM operation.

### <Error amplifier>

The error amplifier is designed to monitor output voltage. The amplifier compares the reference voltage with the feedback voltage divided by the internal voltage divider,  $R_{FB1}$  and  $R_{FB2}$ . When a voltage is lower than the reference voltage, then the voltage is fed back, the output voltage of the error amplifier increases. The error amplifier output is fixed internally to deliver an optimized signal to the mixer.

## ■ OPERATIONAL EXPLANATION(Continued)

### <Current limiting>

The current limiting circuit of the XC9267 series monitors the current that flows through the High-side driver transistor and Low-side driver transistor, and when over-current is detected, the current limiting function activates.

#### (1) High-side driver Tr. current limiting

The current in the High-side driver Tr. is detected to equivalently monitor the peak value of the coil current. The High-side driver Tr. current limiting function forcibly turns off the High-side driver Tr. when the peak value of the coil current reaches the High-side driver current limit value  $I_{LIMH}$ .

High-side driver Tr. current limit value  $I_{LIMH}=1.3A$  (TYP.)

#### (2) Low-side driver Tr. current limiting

The current in the Low-side driver Tr. is detected to equivalently monitor the bottom value of the coil current. The Low-side driver Tr. current limiting function operates when the High-side driver Tr. current limiting value reaches  $I_{LIMH}$ . The Low-side driver Tr. current limiting function prohibits the High-side driver Tr. from turning on in an over-current state where the bottom value of the coil current is higher than the Low-side driver Tr. current limit value  $I_{LIML}$ .

Low side driver Tr. current limit value  $I_{LIML}=0.9A$  (TYP.)

The current foldback circuit operates control to lower the switching frequency  $f_{osc}$ . When the over-current state is released, normal operation resumes.

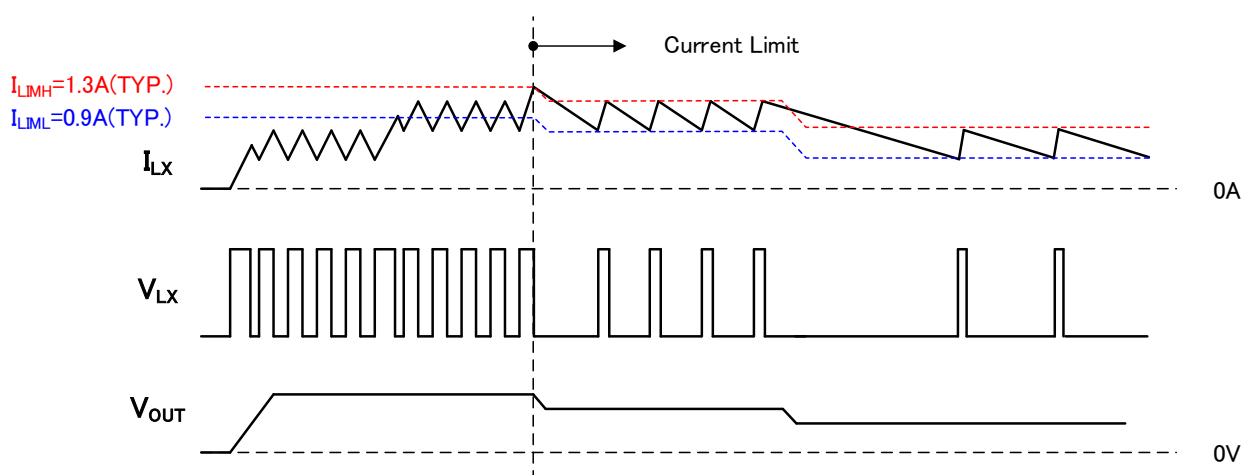

## ■ OPERATIONAL EXPLANATION(Continued)

### <Soft-start function>

The output voltage of XC9267 rises with soft start by slowly raising the reference voltage. The rise time of this reference voltage is the soft start time. The soft-start time is set to  $t_{ss1}$  (TYP. 2.0ms) which is fixed internally or to the time set by adding a capacitor and a resistor to the EN / SS pin whichever is later.

### <Thermal shutdown>

The thermal shutdown (TSD) as an over temperature limit is built in the XC9267 series. When the junction temperature reaches the detection temperature, the driver transistor is forcibly turned off. When the junction temperature falls to the release temperature while in the output stop state, restart takes place by soft-start.

### <UVLO>

When the  $V_{IN}$  pin voltage falls below  $V_{UVLO1}$  (TYP. 2.7V), the driver transistor is forcibly turned off to prevent false pulse output due to instable operation of the internal circuits. When the  $V_{IN}$  pin voltage rises above  $V_{UVLO2}$  (TYP. 2.8V), the UVLO function is released, the soft-start function activates, and output start operation begins. Stopping by UVLO is not shutdown; only pulse output is stopped and the internal circuits continue to operate.

### <Power good>

On USP-6C Package, the output state can be monitored using the power good function. The PG pin is an Nch open drain output, therefore a pull-up resistance (approx. 100k $\Omega$ ) must be connected to the PG pin.

| CONDITIONS |                                  | SIGNAL             |
|------------|----------------------------------|--------------------|
| EN/SS=H    | $V_{FB} > V_{PGDET}$             | H (High impedance) |
|            | $V_{FB} \leq V_{PGDET}$          | L (Low impedance)  |
|            | Thermal Shutdown                 | L (Low impedance)  |
|            | UVLO<br>( $V_{IN} < V_{UVLO1}$ ) | Undefined State    |
| EN/SS=L    | Stand-by                         | L (Low impedance)  |

## NOTE ON USE

- 1) In the case of a temporary and transient voltage drop or voltage rise.  
If the absolute maximum ratings are exceeded, the IC may be deteriorate or destroyed.

### Case 1

If a voltage exceeding the absolute maximum rating is applied to this IC due to chattering by a mechanical switch or an external surge voltage, etc., take measures using a protection circuit such as TVS.

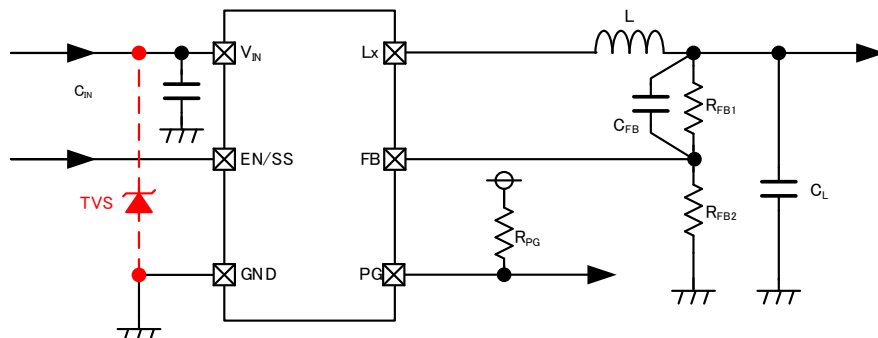

### Case 2

Under conditions where the input voltage is less than the output setting voltage, the absolute maximum rating of the Lx pin may be exceeded, and an overcurrent may flow in the parasitic diode inside the IC.

If excessive current flows in the parasitic diode, take measures such as adding the SBD between VOUT and VIN.

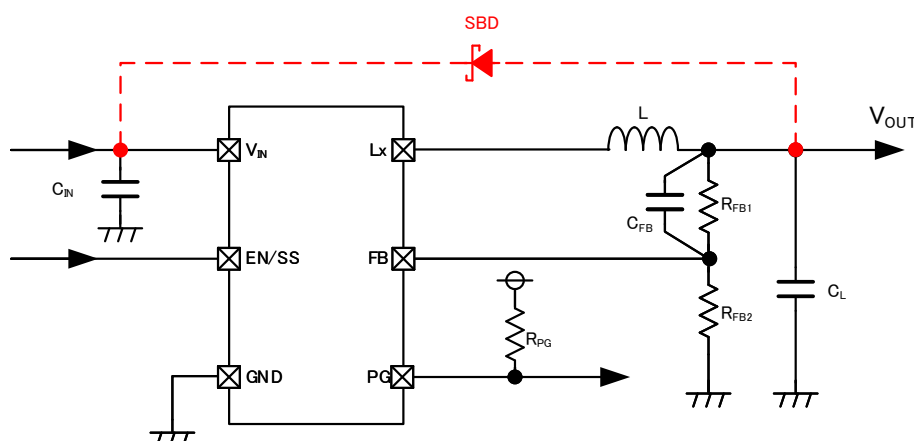

- 2) Make sure that the absolute maximum ratings of the external components and of this IC are not exceeded.
- 3) The DC/DC converter characteristics depend greatly on the externally connected components as well as on the characteristics of this IC, so refer to the specifications and standard circuit examples of each component when carefully considering which components to select.  
Be especially careful of the capacitor characteristics and use X7R or X5R (EIA standard) ceramic capacitors.  
The capacitance decrease caused by the bias voltage may become remarkable depending on the external size of the capacitor.
- 4) The DC/DC converter of this IC uses a current-limiting circuit to monitor the coil peak current. If the potential dropout voltage is large or the load current is large, the peak current will increase, which makes it easier for current limitation to be applied which in turn could cause the operation to become unstable. When the peak current becomes large, adjust the coil inductance and sufficiently check the operation.

The following formula is used to show the peak current.

$$\text{Peak Current: } I_{pk} = (V_{IN} - V_{OUT}) \times V_{OUT} / V_{IN} / (2 \times L \times f_{osc}) + I_{OUT}$$

L: Coil Inductance [H]

f<sub>osc</sub>: Oscillation Frequency [Hz]

I<sub>OUT</sub>: Load Current [A]

- 5) If there is a large dropout voltage, a circuit delay could create the ramp-up of coil current with staircase waveform exceeding the current limit.
- 6) Even in the PWM control, the intermittent operation occurs and the ripple voltage becomes higher, when the minimum On Time is faster than 85ns (typ.) as well as the dropout voltage is large and output current is small.

## ■ NOTE ON USE(Continued)

- 7) The ripple voltage could be increased when switching from discontinuous conduction mode to continuous conduction mode and at switching to 100% Duty cycle. Please evaluate IC well on customer's PCB.
- 8) If the voltage at the EN/SS Pin does not start from 0V but it is at the midpoint potential when the power is switched on, the soft start function may not work properly and it may cause the larger inrush current and bigger ripple voltages.
- 9) Torex places an importance on improving our products and their reliability. We request that users incorporate fail-safe designs and post-aging protection treatment when using Torex products in their systems.
- 10) Instructions of pattern layouts

The operation may become unstable due to noise and/or phase lag from the output current when the wire impedance is high, please place the input capacitor( $C_{IN}$ ) and the output capacitor ( $C_L$ ) as close to the IC as possible.

  - (1) In order to stabilize  $V_{IN}$  voltage level, we recommend that a by-pass capacitor ( $C_{IN}$ ) be connected as close as possible to the  $V_{IN}$  and GND pins.
  - (2) Please mount each external component as close to the IC as possible.
  - (3) Wire external components as close to the IC as possible and use thick, short connecting traces to reduce the circuit impedance.
  - (4) Make sure that the GND traces are as thick as possible, as variations in ground potential caused by high ground currents at the time of switching may result in instability of the IC.
  - (5) Please note that internal driver transistors bring on heat because of the load current and ON resistance of Highside driver transistor, Lowside driver transistor. Please make sure that the heat is dissipated properly, especially at higher temperatures.



<Reference Pattern Layout>

**USP-6C**

Layer 1

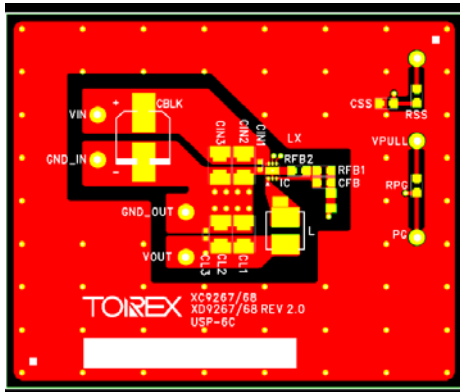

Layer 2

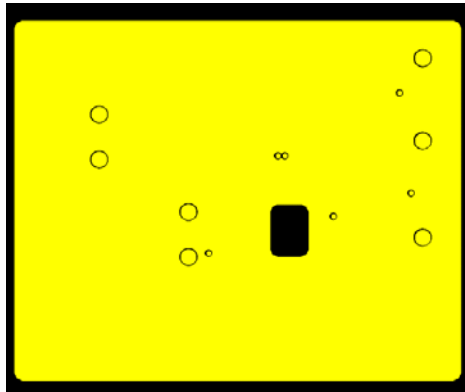

Layer 3

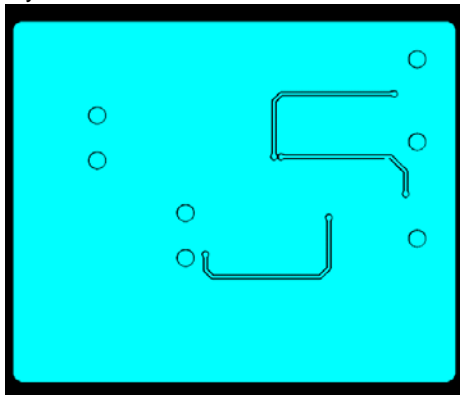

Layer 4

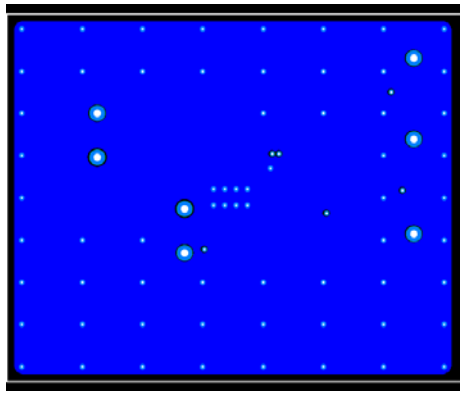

**SOT-89-5**

Layer 1

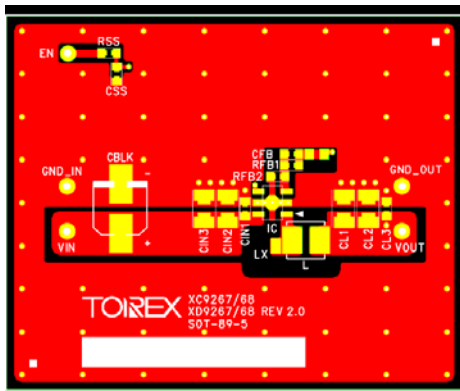

Layer 2

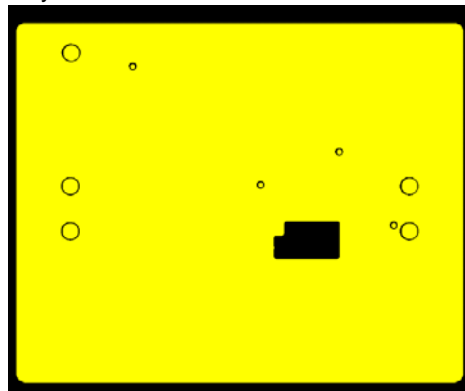

Layer 3

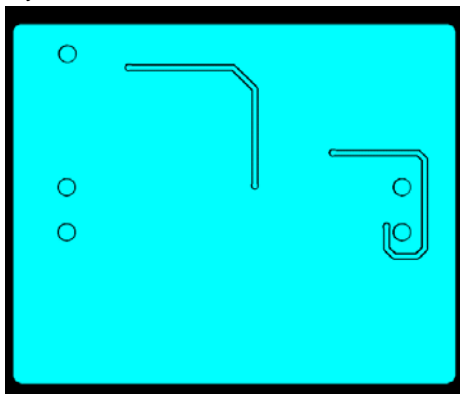

Layer 4

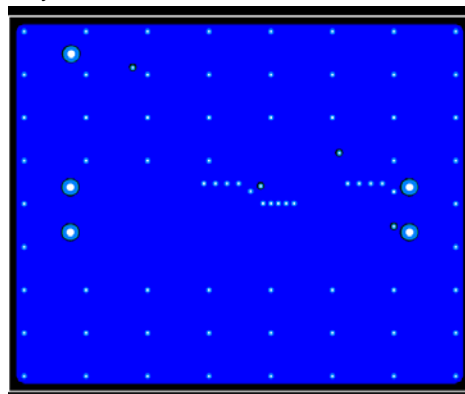

## TYPICAL PERFORMANCE CHARACTERISTICS

### (1) Efficiency vs. Output Current

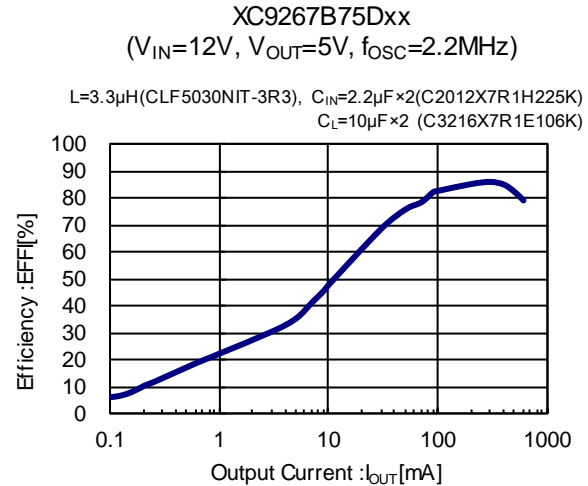
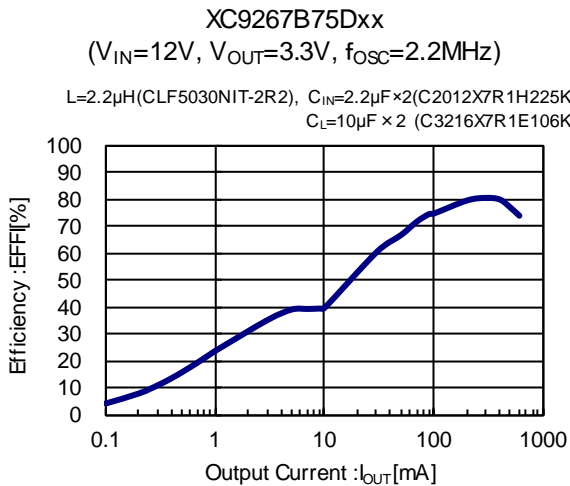
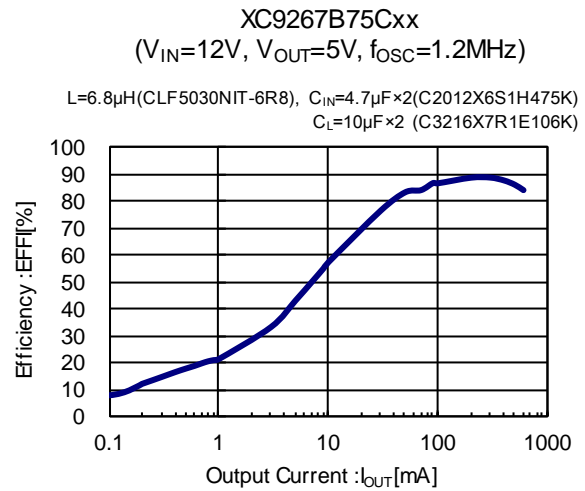
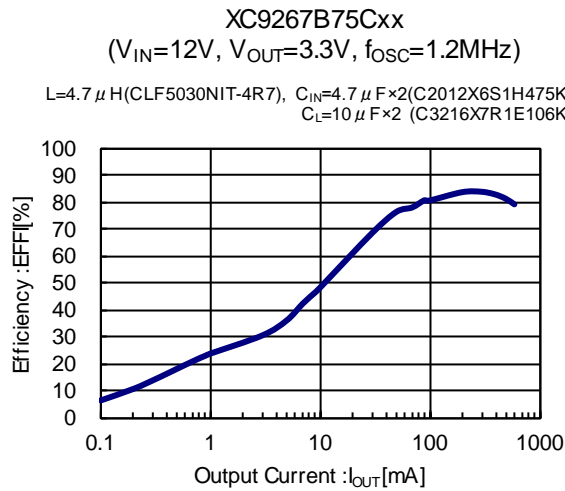

### (2) Output Voltage vs. Output Current

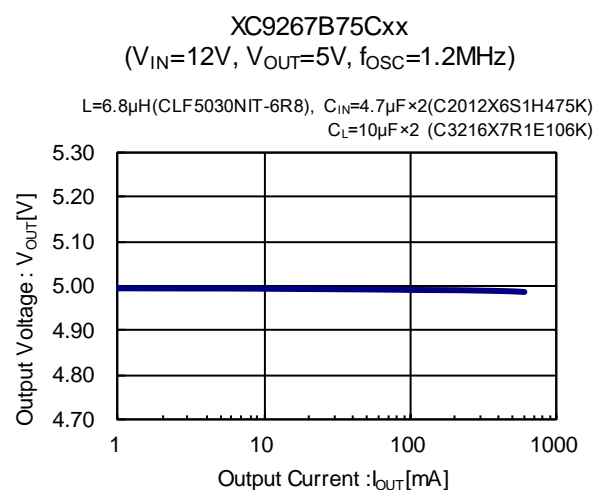
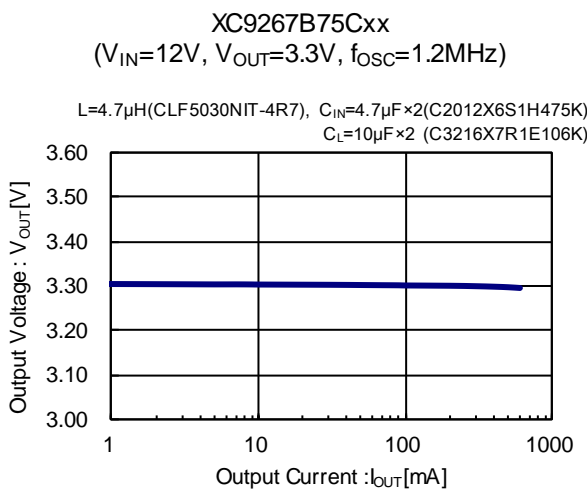

## ■ TYPICAL PERFORMANCE CHARACTERISTICS (Continued)

### (2) Output Voltage vs. Output Current

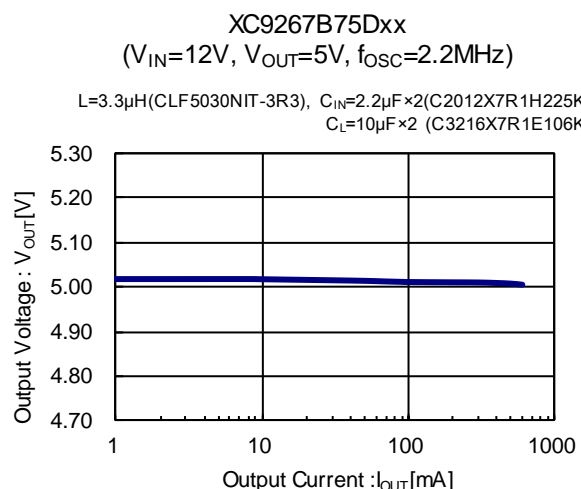
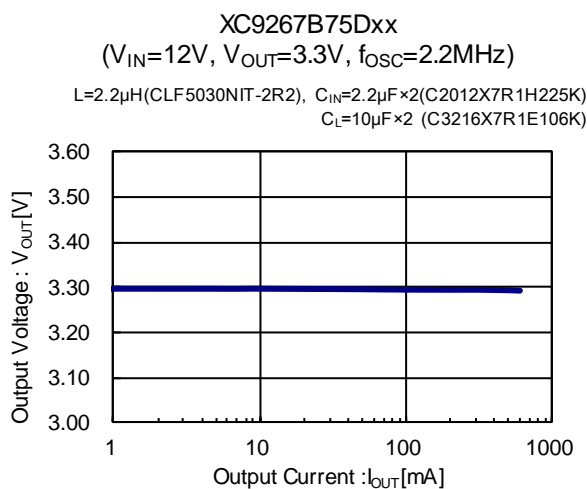

### (3) Ripple Voltage vs. Output Current

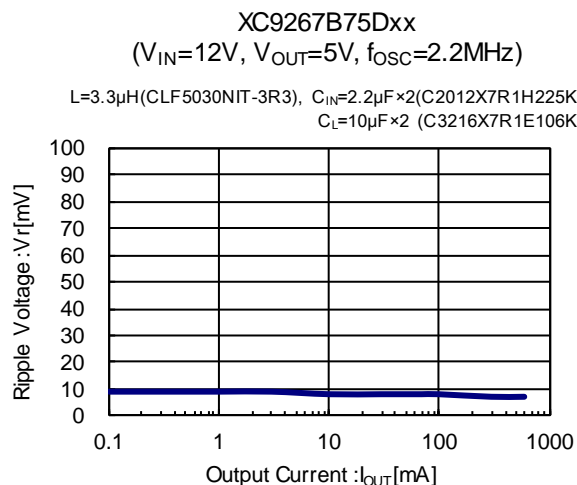
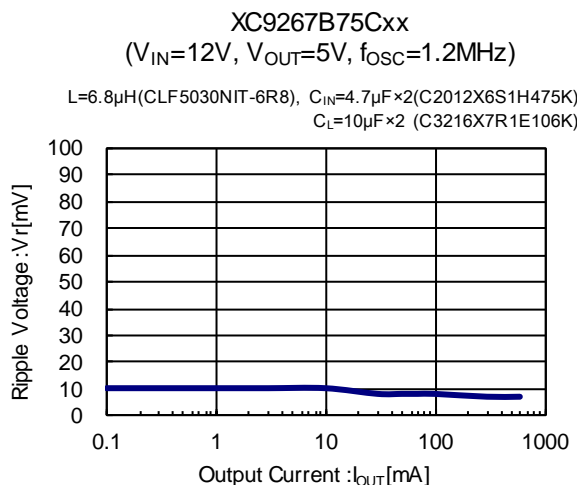

### (4) FB Voltage vs. Ambient Temperature

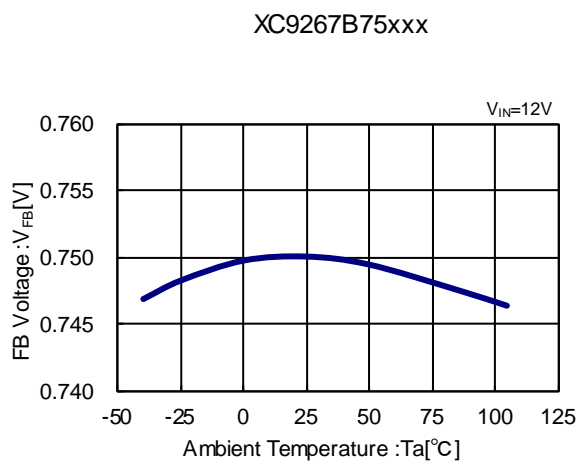

### (5) UVLO Voltage vs. Ambient Temperature

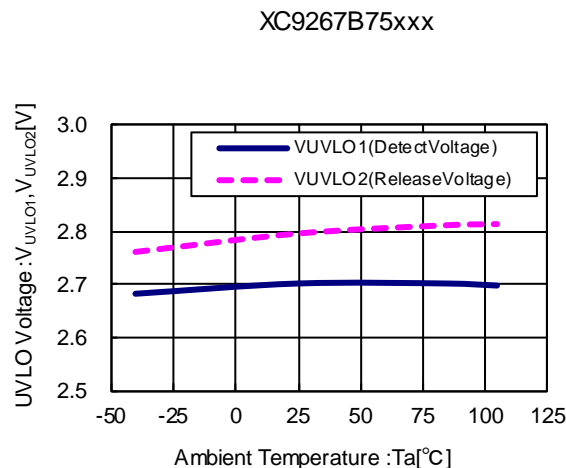

## TYPICAL PERFORMANCE CHARACTERISTICS (Continued)

(6) Oscillation Frequency vs. Ambient Temperature

XC9267B75Cxx  
( $f_{osc}=1.2\text{MHz}$ )

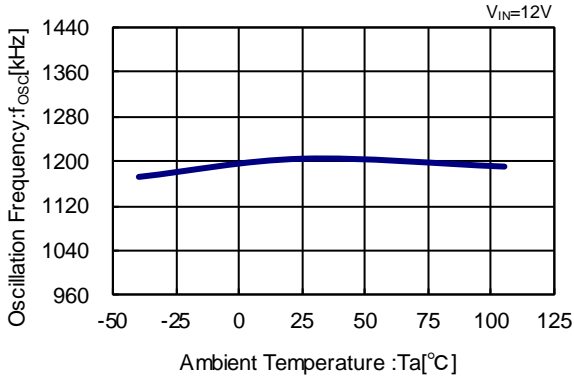

XC9267B75Dxx  
( $f_{osc}=2.2\text{MHz}$ )

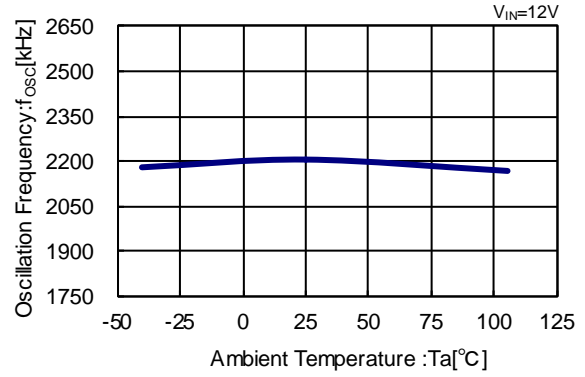

(7) Stand-by Current vs. Ambient Temperature

XC9267B75xxx

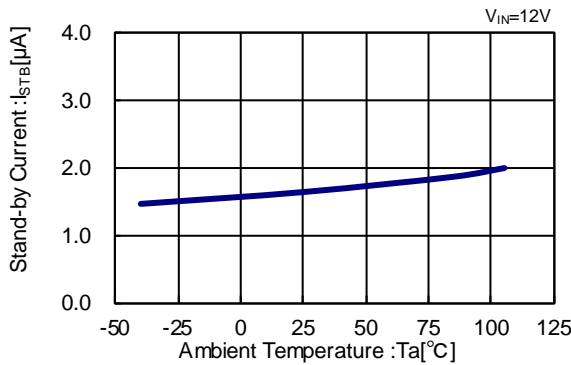

(8) Lx SW ON Resistance vs. Ambient Temperature

XC9267B75xxx

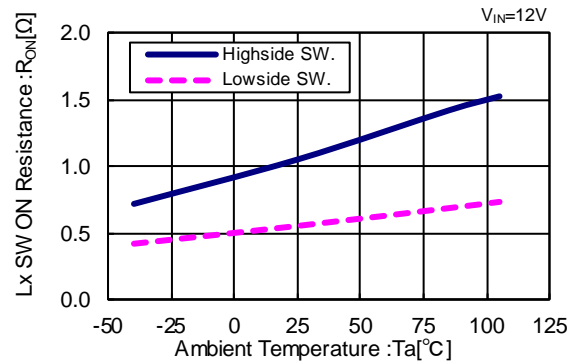

(9) Quiescent Current vs. Ambient Temperature

XC9267B75Cxx  
( $f_{osc}=1.2\text{MHz}$ )

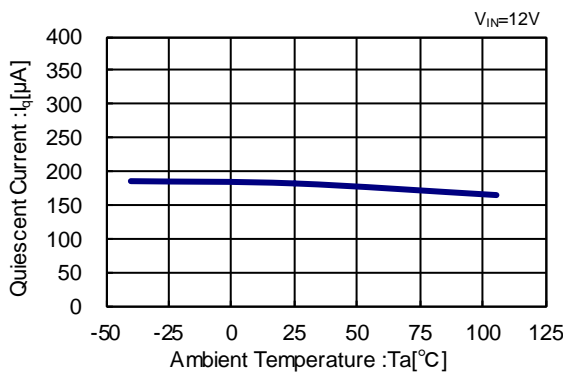

XC9267B75Dxx  
( $f_{osc}=2.2\text{MHz}$ )

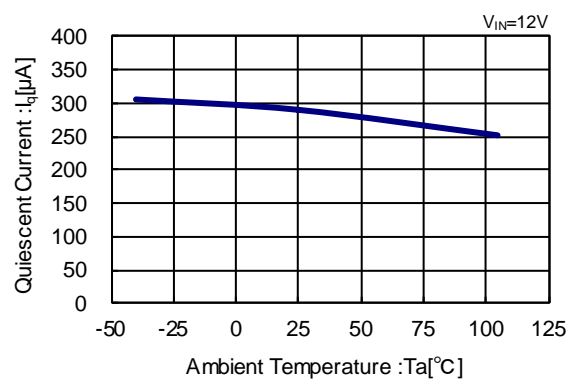

## ■ TYPICAL PERFORMANCE CHARACTERISTICS (Continued)

(10) Internal Soft-Start Time vs. Ambient Temperature

XC9267B75xxx

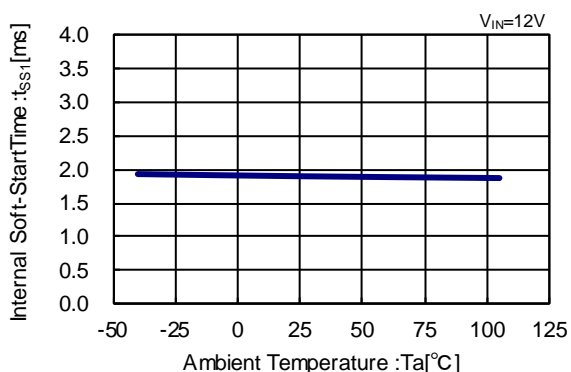

(11) External Soft-Start Time vs. Ambient Temperature

XC9267B75xxx

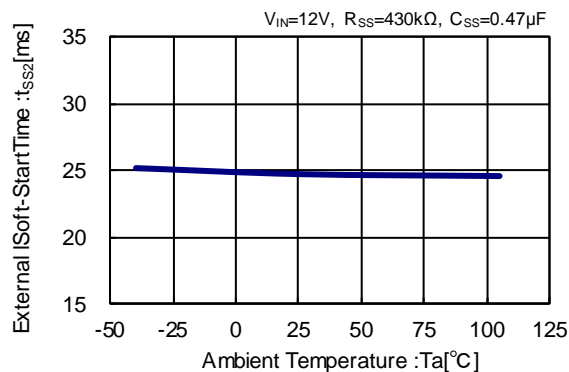

(12) PG Detect Voltage vs. Ambient Temperature

XC9267B75xxx

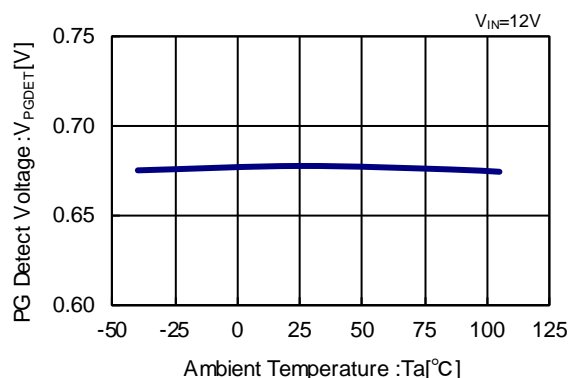

(13) PG Output Voltage vs. Ambient Temperature

XC9267B75xxx

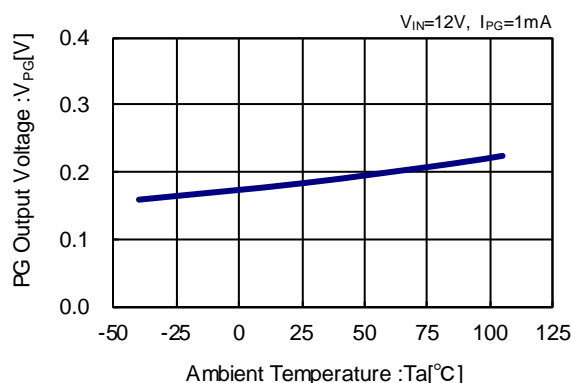

(14) EN/SS Voltage vs. Ambient Temperature

XC9267B75xxx

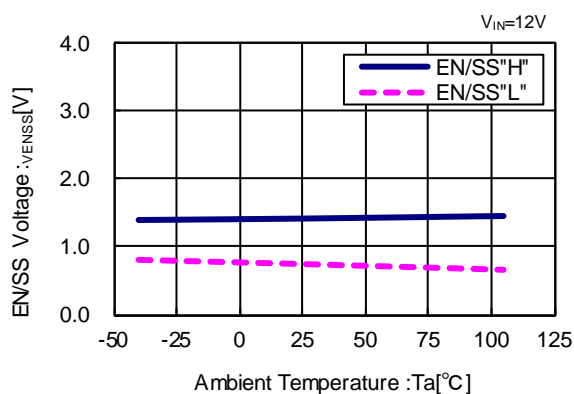

## TYPICAL PERFORMANCE CHARACTERISTICS (Continued)

### (15) Load Transient Response

XC9267B75Cxx,  $f_{OSC}=1.2\text{MHz}$

$V_{IN}=12\text{V}$ ,  $V_{OUT}=3.3\text{V}$ ,  $I_{OUT}=10\text{mA}\rightarrow 300\text{mA}$

$L=4.7\mu\text{H}$ (CLF5030NIT-4R7),  $C_{IN}=4.7\mu\text{F}\times 2$ (C2012X6S1H475K)  
 $C_L=10\mu\text{F}\times 2$  (C3216X7R1E106K)

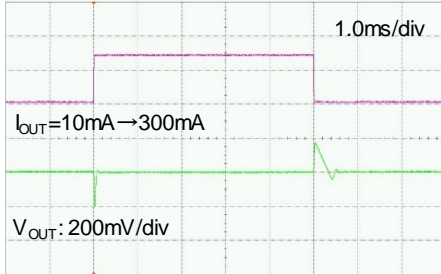

XC9267B75Cxx,  $f_{OSC}=1.2\text{MHz}$

$V_{IN}=24\text{V}$ ,  $V_{OUT}=3.3\text{V}$ ,  $I_{OUT}=10\text{mA}\rightarrow 300\text{mA}$

$L=4.7\mu\text{H}$ (CLF5030NIT-4R7),  $C_{IN}=4.7\mu\text{F}\times 2$ (C2012X6S1H475K)  
 $C_L=10\mu\text{F}\times 2$  (C3216X7R1E106K)

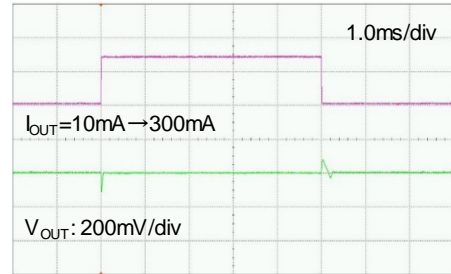

XC9267B75Cxx,  $f_{OSC}=1.2\text{MHz}$

$V_{IN}=12\text{V}$ ,  $V_{OUT}=5.0\text{V}$ ,  $I_{OUT}=10\text{mA}\rightarrow 300\text{mA}$

$L=6.8\mu\text{H}$ (CLF5030NIT-6R8),  $C_{IN}=4.7\mu\text{F}\times 2$ (C2012X6S1H475K)  
 $C_L=10\mu\text{F}\times 2$  (C3216X7R1E106K)

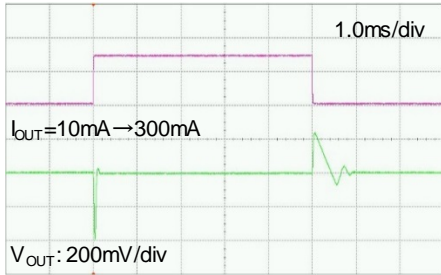

XC9267B75Cxx,  $f_{OSC}=1.2\text{MHz}$

$V_{IN}=24\text{V}$ ,  $V_{OUT}=5.0\text{V}$ ,  $I_{OUT}=10\text{mA}\rightarrow 300\text{mA}$

$L=6.8\mu\text{H}$ (CLF5030NIT-6R8),  $C_{IN}=4.7\mu\text{F}\times 2$ (C2012X6S1H475K)  
 $C_L=10\mu\text{F}\times 2$  (C3216X7R1E106K)

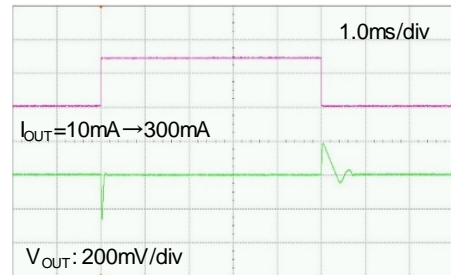

XC9267B75Dxx,  $f_{OSC}=2.2\text{MHz}$

$V_{IN}=12\text{V}$ ,  $V_{OUT}=3.3\text{V}$ ,  $I_{OUT}=10\text{mA}\rightarrow 300\text{mA}$

$L=2.2\mu\text{H}$ (CLF5030NIT-2R2),  $C_{IN}=2.2\mu\text{F}\times 2$ (C2012X7R1H225K)  
 $C_L=10\mu\text{F}\times 2$  (C3216X7R1E106K)

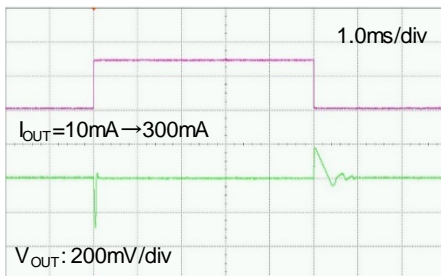

## ■ TYPICAL PERFORMANCE CHARACTERISTICS (Continued)

### (15) Load Transient Response

XC9267B75Dxx,  $f_{OSC}=2.2\text{MHz}$

$V_{IN}=12\text{V}$ ,  $V_{OUT}=5.0\text{V}$ ,  $I_{OUT}=10\text{mA}\rightarrow 300\text{mA}$

$L=3.3\mu\text{H}$ (CLF5030NIT-3R3),  $C_{IN}=2.2\mu\text{F}\times 2$ (C2012X7R1H225K)  
 $C_L=10\mu\text{F}\times 2$  (C3216X7R1E106K)

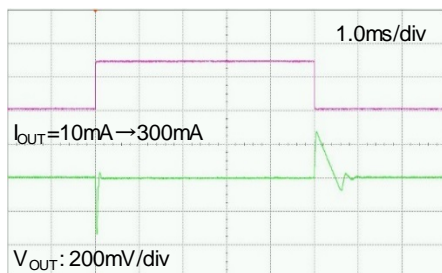

XC9267B75Dxx,  $f_{OSC}=2.2\text{MHz}$

$V_{IN}=24\text{V}$ ,  $V_{OUT}=5.0\text{V}$ ,  $I_{OUT}=10\text{mA}\rightarrow 300\text{mA}$

$L=3.3\mu\text{H}$ (CLF5030NIT-3R3),  $C_{IN}=2.2\mu\text{F}\times 2$ (C2012X7R1H225K)  
 $C_L=10\mu\text{F}\times 2$  (C3216X7R1E106K)

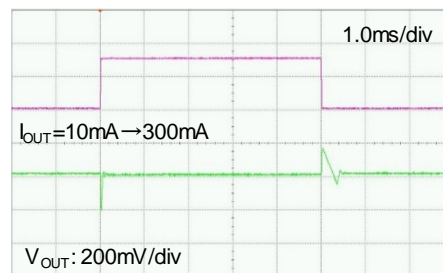

### (16) Input Transient Response

XC9267B75Cxx,  $f_{OSC}=1.2\text{MHz}$

$V_{IN}=8\text{V}\rightarrow 16\text{V}$ ,  $V_{OUT}=3.3\text{V}$ ,  $I_{OUT}=300\text{mA}$

$L=4.7\mu\text{H}$ (CLF5030NIT-4R7),  $C_{IN}=4.7\mu\text{F}\times 2$ (C2012X6S1H475K)  
 $C_L=10\mu\text{F}\times 2$  (C3216X7R1E106K)

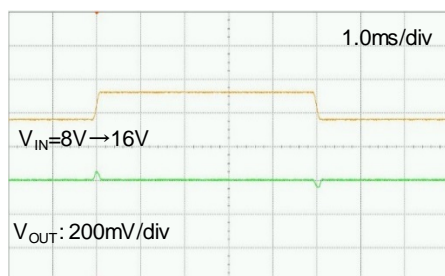

XC9267B75Cxx,  $f_{OSC}=1.2\text{MHz}$

$V_{IN}=16\text{V}\rightarrow 32\text{V}$ ,  $V_{OUT}=3.3\text{V}$ ,  $I_{OUT}=300\text{mA}$

$L=4.7\mu\text{H}$ (CLF5030NIT-4R7),  $C_{IN}=4.7\mu\text{F}\times 2$ (C2012X6S1H475K)  
 $C_L=10\mu\text{F}\times 2$  (C3216X7R1E106K)

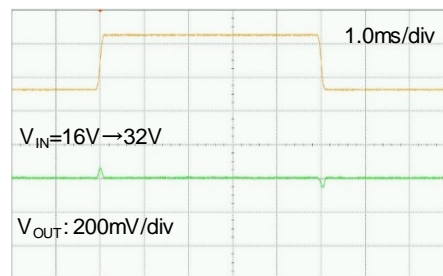

XC9267B75Cxx,  $f_{OSC}=1.2\text{MHz}$

$V_{IN}=8\text{V}\rightarrow 16\text{V}$ ,  $V_{OUT}=5.0\text{V}$ ,  $I_{OUT}=300\text{mA}$

$L=6.8\mu\text{H}$ (CLF5030NIT-6R8),  $C_{IN}=4.7\mu\text{F}\times 2$ (C2012X6S1H475K)  
 $C_L=10\mu\text{F}\times 2$  (C3216X7R1E106K)



XC9267B75Cxx,  $f_{OSC}=1.2\text{MHz}$

$V_{IN}=16\text{V}\rightarrow 32\text{V}$ ,  $V_{OUT}=5.0\text{V}$ ,  $I_{OUT}=300\text{mA}$

$L=6.8\mu\text{H}$ (CLF5030NIT-6R8),  $C_{IN}=4.7\mu\text{F}\times 2$ (C2012X6S1H475K)  
 $C_L=10\mu\text{F}\times 2$  (C3216X7R1E106K)



## TYPICAL PERFORMANCE CHARACTERISTICS (Continued)

### (16) Input Transient Response

XC9267B75Dxx,  $f_{OSC}=2.2\text{MHz}$

$L=2.2\mu\text{H}$ (CLF5030NIT-2R2),  $C_{IN}=2.2\mu\text{F}\times 2$ (C2012X7R1H225K)  
 $C_L=10\mu\text{F}\times 2$ (C3216X7R1E106K)

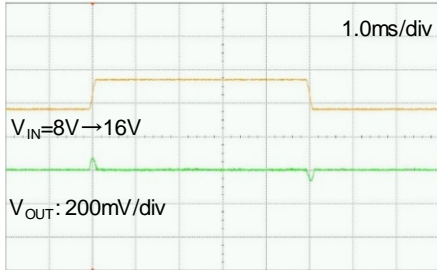

XC9267B75Dxx,  $f_{OSC}=2.2\text{MHz}$

$V_{IN}=8\text{V}\rightarrow 16\text{V}$ ,  $V_{OUT}=5.0\text{V}$ ,  $I_{OUT}=300\text{mA}$

$L=3.3\mu\text{H}$ (CLF5030NIT-3R3),  $C_{IN}=2.2\mu\text{F}\times 2$ (C2012X7R1H225K)  
 $C_L=10\mu\text{F}\times 2$ (C3216X7R1E106K)

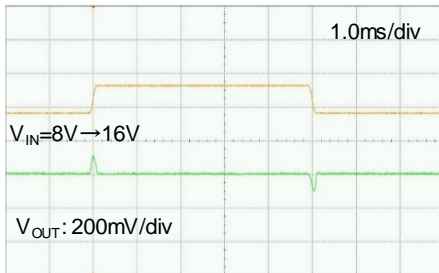

XC9267B75Dxx,  $f_{OSC}=2.2\text{MHz}$

$V_{IN}=16\text{V}\rightarrow 32\text{V}$ ,  $V_{OUT}=5.0\text{V}$ ,  $I_{OUT}=300\text{mA}$

$L=3.3\mu\text{H}$ (CLF5030NIT-3R3),  $C_{IN}=2.2\mu\text{F}\times 2$ (C2012X7R1H225K)  
 $C_L=10\mu\text{F}\times 2$ (C3216X7R1E106K)

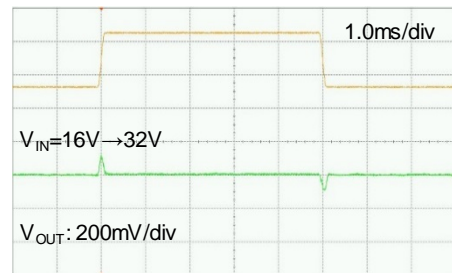

### (17) EN/SS Rising Response

XC9267B75Cxx,  $f_{OSC}=1.2\text{MHz}$

$V_{IN}=12\text{V}$ ,  $V_{ENSS}=0\rightarrow 12\text{V}$ ,  $V_{OUT}=3.3\text{V}$ ,  $I_{OUT}=300\text{mA}$

$L=4.7\mu\text{H}$ (CLF5030NIT-4R7),  $C_{IN}=4.7\mu\text{F}\times 2$ (C2012X6S1H475K)  
 $C_L=10\mu\text{F}\times 2$ (C3216X7R1E106K)

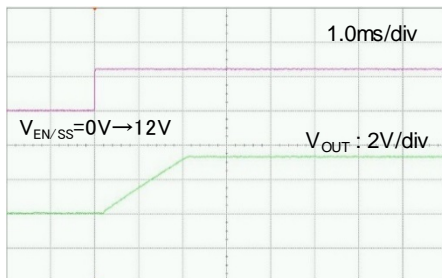

XC9267B75Cxx,  $f_{OSC}=1.2\text{MHz}$

$V_{IN}=24\text{V}$ ,  $V_{ENSS}=0\rightarrow 24\text{V}$ ,  $V_{OUT}=3.3\text{V}$ ,  $I_{OUT}=300\text{mA}$

$L=4.7\mu\text{H}$ (CLF5030NIT-4R7),  $C_{IN}=4.7\mu\text{F}\times 2$ (C2012X6S1H475K)  
 $C_L=10\mu\text{F}\times 2$ (C3216X7R1E106K)

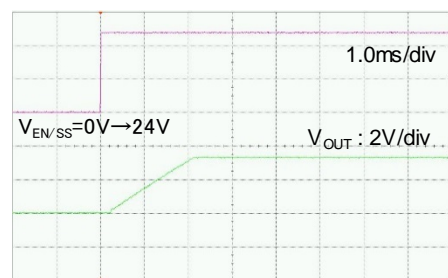



## ■ TYPICAL PERFORMANCE CHARACTERISTICS (Continued)

### (17) EN/SS Rising Response

XC9267B75Cxx,  $f_{OSC}=1.2\text{MHz}$

$V_{IN}=12\text{V}$ ,  $V_{ENSS}=0\rightarrow 12\text{V}$ ,  $V_{OUT}=5\text{V}$ ,  $I_{OUT}=300\text{mA}$

$L=6.8\mu\text{H}$ (CLF5030NIT-6R8),  $C_{IN}=4.7\mu\text{F}\times 2$ (C2012X6S1H475K)  
 $C_L=10\mu\text{F}\times 2$  (C3216X7R1E106K)

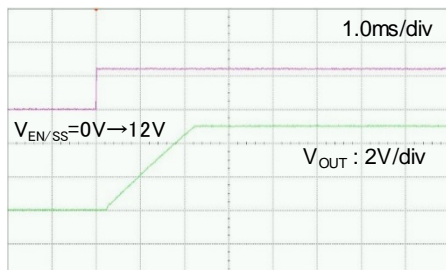

XC9267B75Cxx,  $f_{OSC}=1.2\text{MHz}$

$V_{IN}=24\text{V}$ ,  $V_{ENSS}=0\rightarrow 24\text{V}$ ,  $V_{OUT}=5\text{V}$ ,  $I_{OUT}=300\text{mA}$

$L=6.8\mu\text{H}$ (CLF5030NIT-6R8),  $C_{IN}=4.7\mu\text{F}\times 2$ (C2012X6S1H475K)  
 $C_L=10\mu\text{F}\times 2$  (C3216X7R1E106K)

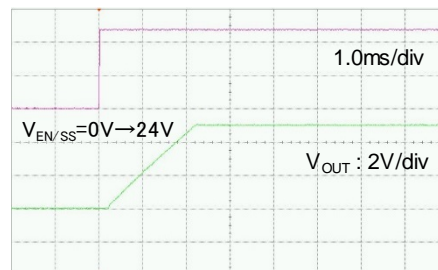

XC9267B75Dxx,  $f_{OSC}=2.2\text{MHz}$

$V_{IN}=12\text{V}$ ,  $V_{ENSS}=0\rightarrow 12\text{V}$ ,  $V_{OUT}=3.3\text{V}$ ,  $I_{OUT}=300\text{mA}$

$L=2.2\mu\text{H}$ (CLF5030NIT-2R2),  $C_{IN}=2.2\mu\text{F}\times 2$ (C2012X7R1H225K)  
 $C_L=10\mu\text{F}\times 2$  (C3216X7R1E106K)

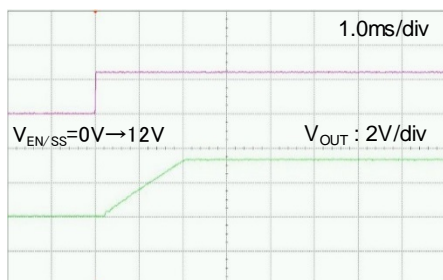

XC9267B75Dxx,  $f_{OSC}=2.2\text{MHz}$

$V_{IN}=12\text{V}$ ,  $V_{ENSS}=0\rightarrow 12\text{V}$ ,  $V_{OUT}=5\text{V}$ ,  $I_{OUT}=300\text{mA}$

$L=3.3\mu\text{H}$ (CLF5030NIT-3R3),  $C_{IN}=2.2\mu\text{F}\times 2$ (C2012X7R1H225K)  
 $C_L=10\mu\text{F}\times 2$  (C3216X7R1E106K)

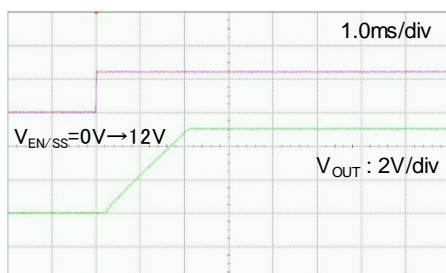

XC9267B75Dxx,  $f_{OSC}=2.2\text{MHz}$

$V_{IN}=24\text{V}$ ,  $V_{ENSS}=0\rightarrow 24\text{V}$ ,  $V_{OUT}=5\text{V}$ ,  $I_{OUT}=300\text{mA}$

$L=3.3\mu\text{H}$ (CLF5030NIT-3R3),  $C_{IN}=2.2\mu\text{F}\times 2$ (C2012X7R1H225K)  
 $C_L=10\mu\text{F}\times 2$  (C3216X7R1E106K)

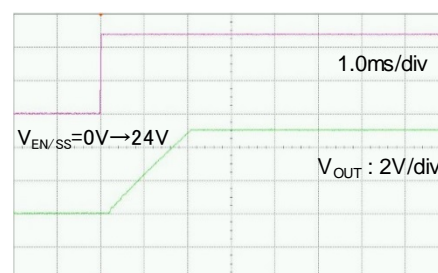

## TYPICAL PERFORMANCE CHARACTERISTICS (Continued)

### (18) VIN Rising Response

XC9267B75Cxx,  $f_{OSC}=1.2\text{MHz}$

$V_{IN}=0\rightarrow 12\text{V}$ ,  $V_{ENSS}=0\rightarrow 12\text{V}$ ,  $V_{OUT}=3.3\text{V}$ ,  $I_{OUT}=300\text{mA}$   
 $L=4.7\mu\text{H}$ (CLF5030NIT-4R7),  $C_{IN}=4.7\mu\text{F}\times 2$ (C2012X6S1H475K)  
 $C_L=10\mu\text{F}\times 2$ (C3216X7R1E106K)

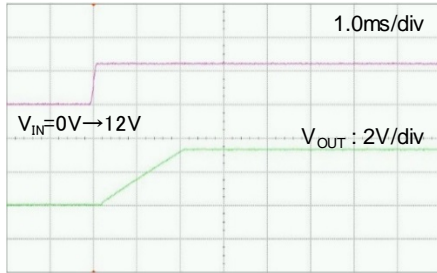

XC9267B75Cxx,  $f_{OSC}=1.2\text{MHz}$

$V_{IN}=0\rightarrow 24\text{V}$ ,  $V_{ENSS}=0\rightarrow 24\text{V}$ ,  $V_{OUT}=3.3\text{V}$ ,  $I_{OUT}=300\text{mA}$   
 $L=4.7\mu\text{H}$ (CLF5030NIT-4R7),  $C_{IN}=4.7\mu\text{F}\times 2$ (C2012X6S1H475K)  
 $C_L=10\mu\text{F}\times 2$ (C3216X7R1E106K)

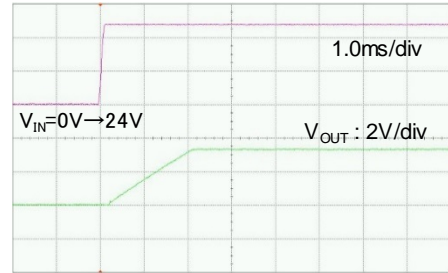

XC9267B75Cxx,  $f_{OSC}=1.2\text{MHz}$

$V_{IN}=0\rightarrow 12\text{V}$ ,  $V_{ENSS}=0\rightarrow 12\text{V}$ ,  $V_{OUT}=5\text{V}$ ,  $I_{OUT}=300\text{mA}$   
 $L=6.8\mu\text{H}$ (CLF5030NIT-6R8),  $C_{IN}=4.7\mu\text{F}\times 2$ (C2012X6S1H475K)  
 $C_L=10\mu\text{F}\times 2$ (C3216X7R1E106K)

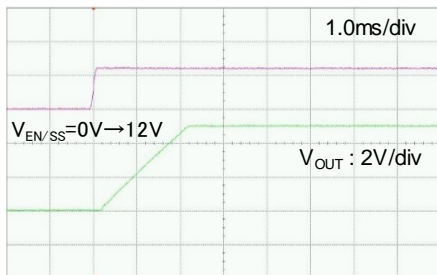

XC9267B75Cxx,  $f_{OSC}=1.2\text{MHz}$

$V_{IN}=0\rightarrow 24\text{V}$ ,  $V_{ENSS}=0\rightarrow 24\text{V}$ ,  $V_{OUT}=5\text{V}$ ,  $I_{OUT}=300\text{mA}$   
 $L=6.8\mu\text{H}$ (CLF5030NIT-6R8),  $C_{IN}=4.7\mu\text{F}\times 2$ (C2012X6S1H475K)  
 $C_L=10\mu\text{F}\times 2$ (C3216X7R1E106K)

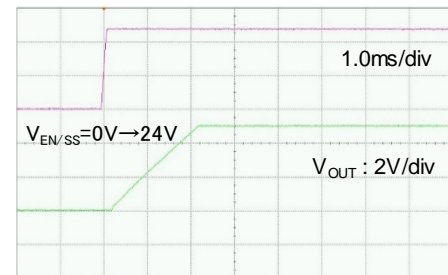

XC9267B75Dxx,  $f_{OSC}=2.2\text{MHz}$

$V_{IN}=0\rightarrow 12\text{V}$ ,  $V_{ENSS}=0\rightarrow 12\text{V}$ ,  $V_{OUT}=3.3\text{V}$ ,  $I_{OUT}=300\text{mA}$   
 $L=2.2\mu\text{H}$ (CLF5030NIT-2R2),  $C_{IN}=2.2\mu\text{F}\times 2$ (C2012X7R1H225K)  
 $C_L=10\mu\text{F}\times 2$ (C3216X7R1E106K)

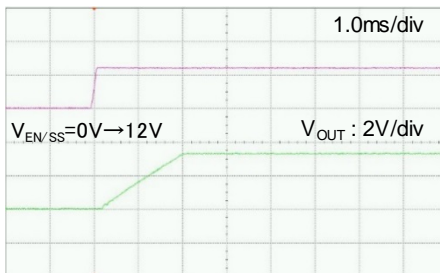

## ■ TYPICAL PERFORMANCE CHARACTERISTICS (Continued)

### (18) VIN Rising Response

XC9267x75D,  $f_{OSC}=2.2\text{MHz}$

$V_{IN}=0\rightarrow 12\text{V}$ ,  $V_{ENSS}=0\rightarrow 12\text{V}$ ,  $V_{OUT}=5\text{V}$ ,  $I_{OUT}=300\text{mA}$

$L=3.3\mu\text{H}$ (CLF5030NIT-3R3N-D),  $C_{IN}=2.2\mu\text{F}\times 2$ (C2012X7R1H225K)  
 $C_L=10\mu\text{F}\times 2$ (C3216X7R1E106K)

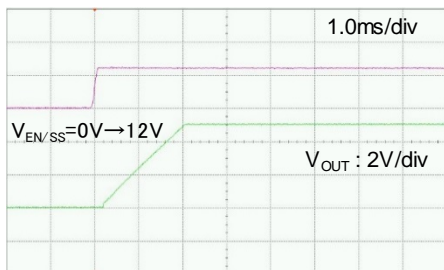

XC9267B75Dxx,  $f_{OSC}=2.2\text{MHz}$

$V_{IN}=0\rightarrow 24\text{V}$ ,  $V_{ENSS}=0\rightarrow 24\text{V}$ ,  $V_{OUT}=5\text{V}$ ,  $I_{OUT}=300\text{mA}$

$L=3.3\mu\text{H}$ (CLF5030NIT-3R3N-D),  $C_{IN}=2.2\mu\text{F}\times 2$ (C2012X7R1H225K)  
 $C_L=10\mu\text{F}\times 2$ (C3216X7R1E106K)

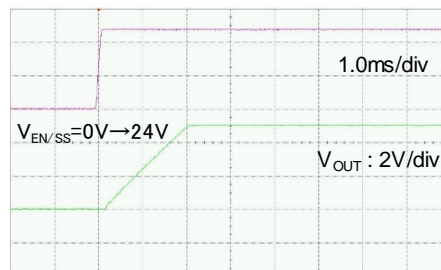

## ■ PACKAGING INFORMATION

For the latest package information go to, [www.torexsemi.com/technical-support/packages](http://www.torexsemi.com/technical-support/packages)

| PACKAGE  | OUTLIN / LAND PATTERN        | THERMAL CHARACTERISTICS |  |
|----------|------------------------------|-------------------------|--|
| SOT-89-5 | <a href="#">SOT-89-5 PKG</a> | Standard Board          | <a href="#">SOT-89-5 Power Dissipation</a> |
|          |                              | JESD51-7 Board          |  |
| USP-6C   | <a href="#">USP-6C PKG</a>   | Standard Board          | <a href="#">USP-6C Power Dissipation</a>   |
|          |                              | JESD51-7 Board          |  |

## MARKING RULE

### ● SOT-89-5

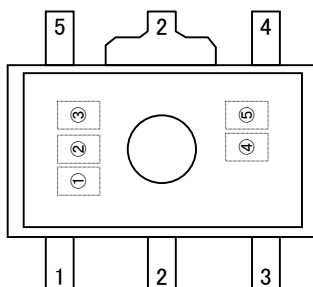

①② represents product series, products type,

| MARK |   | PRODUCT SERIES |
|------|---|----------------|
| ①    | ② |                |
| 5    | 1 | XC9267B75***-G |

※USP-6C Under dot

### ● USP-6C(Under dot)

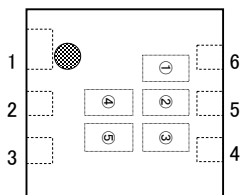

③ represents Oscillation Frequency

| MARK | Oscillation Frequency | PRODUCT SERIES |
|------|-----------------------|----------------|
| N    | 1.2MHz                | XC9267B75C**-G |
| U    | 2.2MHz                | XC9267B75D**-G |

④⑤ represents production lot number  
01~09, 0A~0Z, 11~9Z, A1~A9, AA~AZ, B1~ZZ repeated  
(G, I, J, O, Q, W excluded)\* No character inversion used.

1. The product and product specifications contained herein are subject to change without notice to improve performance characteristics. Consult us, or our representatives before use, to confirm that the information in this datasheet is up to date.
2. The information in this datasheet is intended to illustrate the operation and characteristics of our products. We neither make warranties or representations with respect to the accuracy or completeness of the information contained in this datasheet nor grant any license to any intellectual property rights of ours or any third party concerning with the information in this datasheet.
3. Applicable export control laws and regulations should be complied and the procedures required by such laws and regulations should also be followed, when the product or any information contained in this datasheet is exported.
4. The product is neither intended nor warranted for use in equipment of systems which require extremely high levels of quality and/or reliability and/or a malfunction or failure which may cause loss of human life, bodily injury, serious property damage including but not limited to devices or equipment used in 1) nuclear facilities, 2) aerospace industry, 3) medical facilities, 4) automobile industry and other transportation industry and 5) safety devices and safety equipment to control combustions and explosions. Do not use the product for the above use unless agreed by us in writing in advance.
5. Although we make continuous efforts to improve the quality and reliability of our products; nevertheless Semiconductors are likely to fail with a certain probability. So in order to prevent personal injury and/or property damage resulting from such failure, customers are required to incorporate adequate safety measures in their designs, such as system fail safes, redundancy and fire prevention features.
6. Our products are not designed to be Radiation-resistant.
7. Please use the product listed in this datasheet within the specified ranges.
8. We assume no responsibility for damage or loss due to abnormal use.
9. All rights reserved. No part of this datasheet may be copied or reproduced unless agreed by Torex Semiconductor Ltd in writing in advance.

TOREX SEMICONDUCTOR LTD.