

I²C-BUS INTERFACE REAL TIME CLOCK MODULE

RTC-8564JE/NB RX-8564CF

Product number (please refer to page 2)

Q4185647x000100 Q4185649x0000200

Q418564Ax000100

- Built-in crystal unit allows adjustment-free efficient operation.
- Compliant with I²C high-speed bus specifications. (400 kHz)
- Equipped with alarm, timer, and frequency output (32.768 kHz, 1024 Hz, 32 Hz, 1 Hz) features.
- Operating in wide voltage range from 1.8 V to 5.5 V, and in wide range of clock voltage from 1.0 V to 5.5 V. (RTC-8564JE/NB : -20°C to +70°C / RX-8564CF: +25°C)
- Low power consumption at 275 nA/3.0 V. (Typ.)

The details are mentioned in the application manual.

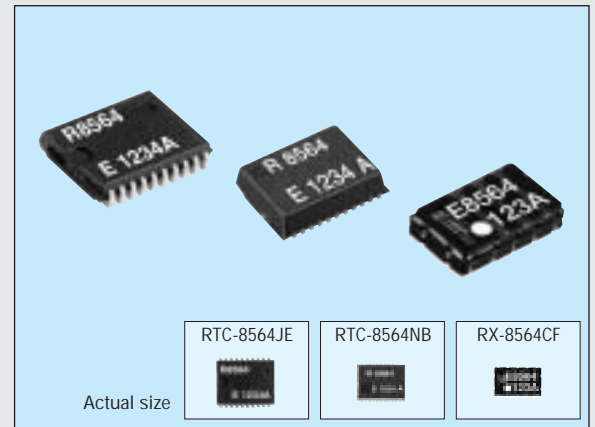

<http://www.epsondevice.com>

The I²C-Bus is a trademark of Philips Electronics N.V.

Specifications (characteristics)

Absolute Max. rating

Item	Symbol	Condition	Min.	Max.	Unit
Supply voltage	V _{DD}	V _{DD} to GND	-0.5	+6.5	V
Input voltage	V _I	Input pin	GND-0.5	V _{DD} +0.5	V
Output voltage	V _O	INT pins			
DC Input current	I _I	—	-10	10	mA
DC Output current	I _O	—	—	—	—
Storage temperature	T _{STG}	Stored as bare product after unpacking	-55	+125	°C

Operating range

Item	Symbol	Condition	Min.	Max.	Unit
Power voltage	V _{DD}	I ² C-BUS access at 400 kHz	1.8	5.5	V
Clock voltage	V _{CLK}	—	V _{LOW}	—	—
Operating temperature	T _{OPR}	No condensation	-40	+85	°C

Frequency characteristics

Item	Symbol	Condition	Range	Unit
Frequency tolerance	Δf/f ₀	T _a =+25 °C, V _{DD} =3.0 V	5±23*	× 10 ⁻⁶
Oscillation start-up time	t _{STA}	T _a =+25 °C, V _{DD} =1.8 V	3 Max.	s
Frequency temperature characteristics	T _{OP}	Reference at +25 °C, T _a =-10 °C to +70 °C, V _{DD} =3.0 V	+10 -120	× 10 ⁻⁶
Frequency voltage characteristics	f/V	RTC-8564JE/NB T _a =+25 °C, V _{DD} =1.0 V to 5.5 V RX-8564CF T _a =+25 °C, V _{DD} =1.8 V to 5.5 V	±2 Max.	× 10 ⁻⁶ /V
Aging	f _a	T _a =+25 °C, V _{DD} =3.0 V	±5	× 10 ⁴ /year

* Please ask tighter tolerance

DC characteristics

(GND=0 V, V_{DD}=1.8 V to 5.5 V, T_a=-40 °C to +85 °C)

Item	Pin	Symbol	Condition	Min.	Typ.	Max.	Unit	
Power current (during access)	—	I _{DD0}	f _{SCL} =400 kHz f _{SCL} =100 kHz	—	—	800 200	μA	
Power current (not during access) (CLKOUT=0 Hz)			f _{SCL} =0 Hz, V _{DD} =5.0 V f _{SCL} =0 Hz, V _{DD} =3.0 V f _{SCL} =0 Hz, V _{DD} =2.0 V			0.33 0.275 0.25		0.80 0.70 0.65
Power current (not during access) (CLKOUT=32.768 kHz)			f _{SCL} =0 Hz, V _{DD} =5.0 V f _{SCL} =0 Hz, V _{DD} =3.0 V f _{SCL} =0 Hz, V _{DD} =2.0 V			2.5 1.5 1.1		3.4 2.2 1.6
"L" input voltage	—	V _{IL}	—	-0.5	—	0.3V _{DD}	V	
"H" input voltage	—	V _{IH}	—	0.7V _{DD}	—	V _{DD} +0.5		
"L" output current	SDA	I _{OL}	V _{OL} =0.4 V, V _{DD} =5 V	-3	—	—	mA	
"L" output current	INT	I _{OL}						
"H" output current	CLKOUT	I _{OH}	—	—	—	1	mA	
Leakage current	—	I _{LO}	V _{OUT} =V _{DD} or GND	-1	—	1	μA	
Low voltage detection	—	V _{LOW}	T _a =-40 °C to +85 °C	—	0.9	1.1	V	
RTC-8564JE/NB			T _a =-20 °C to +70 °C			1.0		
Low voltage detection			T _a =-40 °C to +85 °C			1.2		
RX-8564CF			T _a =+25 °C			1.0		

External dimensions/Terminal connection

(Unit: mm)

RTC-8564JE (VSOJ 20-pin)

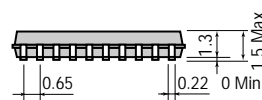
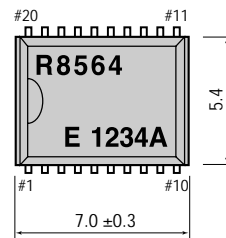

No.	Pin terminal	No.	Pin terminal
1	N.C	20	N.C
2	N.C	19	N.C
3	CLKOE	18	N.C
4	V _{DD}	17	N.C
5	CLKOUT	16	N.C
6	SCL	15	N.C
7	SDA	14	N.C
8	(GND)	13	N.C
9	GND	12	N.C
10	INT	11	N.C

RTC-8564NB (SON 22-pin)

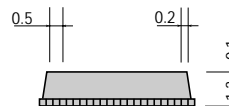
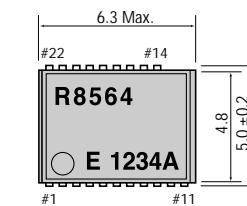

No.	Pin terminal	No.	Pin terminal
1	INT	22	N.C
2	GND	21	N.C
3	(GND)	20	N.C
4	N.C	19	N.C
5	SDA	18	N.C
6	SCL	17	N.C
7	CLKOUT	16	N.C
8	V _{DD}	15	N.C
9	CLKOE	14	N.C
10	N.C	13	—
11	N.C	12	—

RX-8564CF (SON 10-pin)

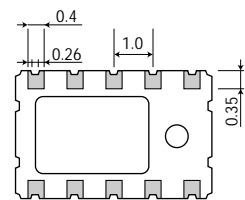
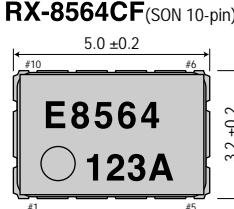

No.	Pin terminal	No.	Pin terminal
1	V _{DD}	10	CLKOE
2	CLKOUT	9	N.C
3	N.C	8	N.C
4	SCL	7	INT
5	SDA	6	GND

Metal may be exposed on the top or bottom of this product. This won't affect any quality, reliability or electrical spec.

Register table

Address	Register symbol	bit 7	bit 6	bit 5	bit 4	bit 3	bit 2	bit 1	bit 0
0	Control 1	TEST	0	STOP	0	TEST	0	0	0
1	Control 2	0	0	0	TI/TP	AF	TF	AIE	TIE
2	Sec	VL	S 40	S 20	S 10	S 8	S 4	S 2	S 1
3	Min	*	Min 40	Min 20	Min 10	Min 8	Min 4	Min 2	Min 1
4	Hour	*	*	Hour 20	Hour 10	Hour 8	Hour 4	Hour 2	Hour 1
5	Day	*	*	Day 20	Day 10	Day 8	Day 4	Day 2	Day 1
6	Day of Week	*	*	*	*	*	W 4	W 2	W 1
7	Month/Century	C	*	*	Month 10	Month 8	Month 4	Month 2	Month 1
8	Year	Year 80	Year 40	Year 20	Year 10	Year 8	Year 4	Year 2	Year 1
9	Minutes Alarm	AE	A-Min 40	A-Min 20	A-Min 10	A-Min 8	A-Min 4	A-Min 2	A-Min 1
A	Hours Alarm	AE	*	A-Hr 20	A-Hr 10	A-Hr 8	A-Hr 4	A-Hr 2	A-Hr 1
B	Day Alarm	AE	*	A-Day 20	A-Day 10	A-Day 8	A-Day 4	A-Day 2	A-Day 1
C	Week Alarm	AE	*	*	*	*	A-W 4	A-W 2	A-W 1
D	CLKOUT frequency	FE	*	*	*	*	*	FD1	FD0
E	Timer control	TE	*	*	*	*	*	TD1	TD0
F	Timer	128	64	32	16	8	4	2	1

0 : Always set this bit to "0".

AC characteristics

(VDD=1.8 V to 5.5 V, Ta=-40 °C to +85 °C)

Item	Symbol	Min.	Max.	Unit
SCL clock frequency	f _{SCL}	—	400	kHz
Tolerance spike time on bus	t _{SP}	—	50	ns
Start condition set-up time	t _{SU;STA}	0.6	—	μs
Start condition Hold time	t _{HD;STA}			
SCL "L" time	t _{LOW}	1.3	—	
SCL "H" time	t _{HIGH}			
SCL and SDA rise time	t _r	0.3	—	
SCL and SDA fall time	t _f			
Data set-up time	t _{SU;DAT}	100	—	ns
Data hold time	t _{HD;DAT}			
Stop condition set-up time	t _{SU;STO}	0.6	—	μs

Block diagram

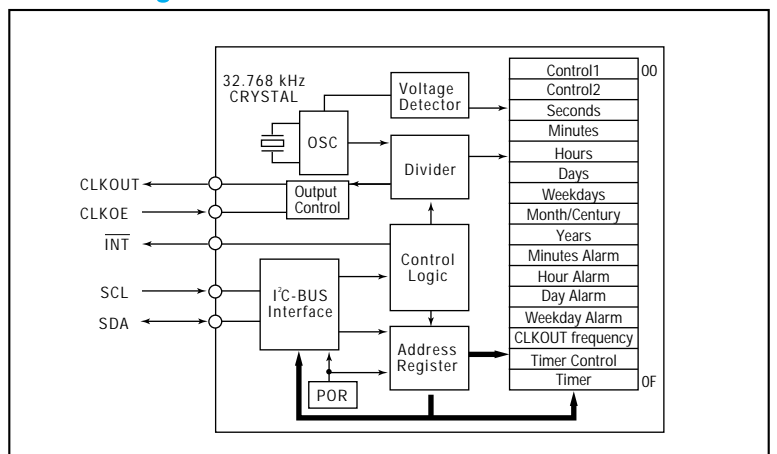

Timing chart

