

LM7321/LM7322 Rail-to-Rail Input/Output ±15V, High Output Current and Unlimited Capacitive Load Operational Amplifier

General Description

The LM7321/LM7322 are rail-to-rail input and output amplifiers with wide operating voltages and high output currents. The LM7321/LM7322 are efficient, achieving 18 V/μs slew rate and 20 MHz unity gain bandwidth while requiring only 1 mA of supply current per op amp. The LM7321/LM7322 performance is fully specified for operation at 2.7V, ±5V and ±15V.

The LM7321/LM7322 are designed to drive unlimited capacitive loads without oscillations. All LM7321 and LM7322 parts are tested at -40°C, 125°C, and 25°C, with modern automatic test equipment. High performance from -40°C to 125°C, detailed specifications, and extensive testing makes them suitable for industrial, automotive, and communications applications.

Greater than rail-to-rail input common mode voltage range with 50 dB of common mode rejection across this wide voltage range, allows both high side and low side sensing. Most device parameters are insensitive to power supply voltage, and this makes the parts easier to use where supply voltage may vary, such as automotive electrical systems and battery powered equipment. These amplifiers have true rail-to-rail output and can supply a respectable amount of current (15 mA) with minimal headroom from either rail (300 mV) at low distortion (0.05% THD+Noise). There are several package options for each part. Standard SOIC versions of both parts make upgrading existing designs easy. LM7322 is offered in a space saving 8-Pin MSOP package. The LM7321 is offered in small SOT23-5 package, which makes it easy to place this part close to sensors for better circuit performance.

Features

($V_S = \pm 15V$, $T_A = 25^\circ C$, Typical values unless specified.)

- Wide supply voltage range 2.5V to 32V
- Output current +65 mA/-100 mA
- Gain bandwidth product 20 MHz
- Slew rate 18 V/μs
- Capacitive load tolerance Unlimited
- Input common mode voltage 0.3V beyond rails
- Input voltage noise 15 nV/√Hz
- Input current noise 1.3 pA/√Hz
- Supply current/channel 1.1 mA
- Distortion THD+Noise -86 dB
- Temperature range -40°C to 125°C
- Tested at -40°C, 25°C and 125°C at 2.7V, ±5V, ±15V.

Applications

- Driving MOSFETs and power transistors
- Capacitive proximity sensors
- Driving analog optocouplers
- High side sensing
- Below ground current sensing
- Photodiode biasing
- Driving varactor diodes in PLLs
- Wide voltage range power supplies
- Automotive
- International power supplies

Typical Performance Characteristics

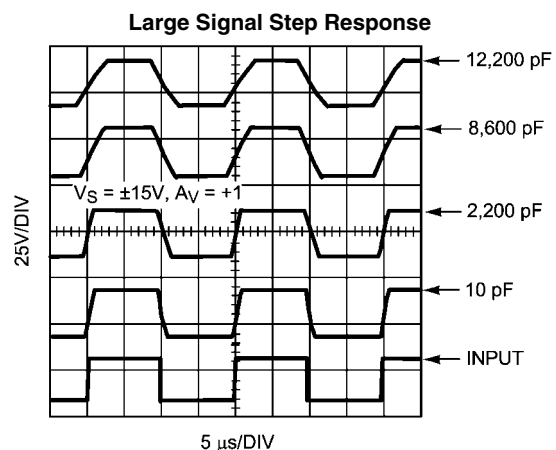
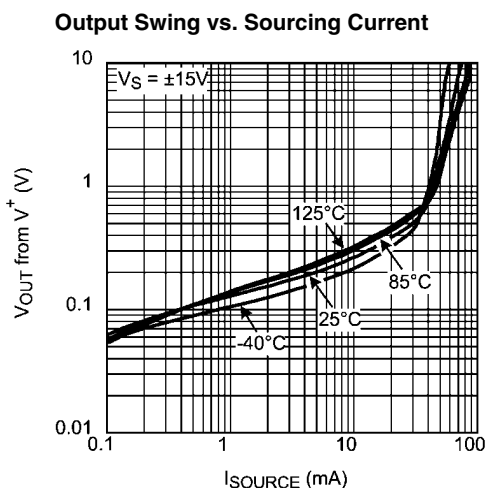

Absolute Maximum Ratings (Note 1)

If Military/Aerospace specified devices are required, please contact the National Semiconductor Sales Office/Distributors for availability and specifications.

ESD Tolerance (Note 2)	
Human Body Model	2 kV
Machine Model	200V
Charge-Device Model	1 kV
V _{IN} Differential	±10V
Output Short Circuit Current	(Note 3)
Supply Voltage (V _S = V ⁺ - V ⁻)	35V
Voltage at Input/Output pins	V ⁺ +0.8V, V ⁻ -0.8V
Storage Temperature Range	-65°C to 150°C

Junction Temperature (Note 4)	150°C
Soldering Information:	
Infrared or Convection (20 sec.)	235°C
Wave Soldering (10 sec.)	260°C

Operating Ratings

Supply Voltage (V _S = V ⁺ - V ⁻)	2.5V to 32V
Temperature Range (Note 4)	-40°C to 125°C
Package Thermal Resistance, θ _{JA} , (Note 4)	
5-Pin SOT-23	325°C/W
8-Pin MSOP	235°C/W
8-Pin SOIC	165°C/W

2.7V Electrical Characteristics (Note 5)

Unless otherwise specified, all limits guaranteed for T_A = 25°C, V⁺ = 2.7V, V⁻ = 0V, V_{CM} = 0.5V, V_{OUT} = 1.35V, and R_L > 1 MΩ to 1.35V. **Boldface** limits apply at the temperature extremes.

Symbol	Parameter	Condition	Min (Note 7)	Typ (Note 6)	Max (Note 7)	Units
V _{OS}	Input Offset Voltage	V _{CM} = 0.5V & V _{CM} = 2.2V	-5 -6	±0.7	+5 +6	mV
TC V _{OS}	Input Offset Voltage Temperature Drift	V _{CM} = 0.5V & V _{CM} = 2.2V (Note 8)		±2		µV/C
I _B	Input Bias Current	V _{CM} = 0.5V (Note 9)	-2.0 -2.5	-1.2		µA
		V _{CM} = 2.2V (Note 9)		0.45	1.0 1.5	
I _{OS}	Input Offset Current	V _{CM} = 0.5V and V _{CM} = 2.2V		20	200 300	nA
CMRR	Common Mode Rejection Ratio	0V ≤ V _{CM} ≤ 1.0V	70 60	100		dB
		0V ≤ V _{CM} ≤ 2.7V	55 50	70		
PSRR	Power Supply Rejection Ratio	2.7V ≤ V _S ≤ 30V	78 74	104		dB
CMVR	Common Mode Voltage Range	CMRR > 50 dB		-0.3	-0.1 0.0	V
			2.8 2.7	3.0		
A _{VOL}	Open Loop Voltage Gain	0.5V ≤ V _O ≤ 2.2V R _L = 10 kΩ to 1.35V	65 62	72		dB
		0.5V ≤ V _O ≤ 2.2V R _L = 2 kΩ to 1.35V	59 55	66		
V _{OUT}	Output Voltage Swing High	R _L = 10 kΩ to 1.35V V _{ID} = 100 mV		50	150 160	mV from either rail
		R _L = 2 kΩ to 1.35V V _{ID} = 100 mV		100	250 280	
	Output Voltage Swing Low	R _L = 10 kΩ to 1.35V V _{ID} = -100 mV		20	120 150	
		R _L = 2 kΩ to 1.35V V _{ID} = -100 mV		40	120 150	

Symbol	Parameter	Condition	Min (Note 7)	Typ (Note 6)	Max (Note 7)	Units
I_{OUT}	Output Current	Sourcing $V_{ID} = 200\text{ mV}$, $V_{OUT} = 0\text{V}$ (Note 3)	30 20	48		mA
		Sinking $V_{ID} = -200\text{ mV}$, $V_{OUT} = 2.7\text{V}$ (Note 3)	40 30	65		
I_S	Supply Current	LM7321		0.95	1.3 1.9	mA
		LM7322		2.0	2.5 3.8	
SR	Slew Rate (Note 10)	$A_V = +1$, $V_I = 2\text{V}$ Step		8.5		V/ μs
f_u	Unity Gain Frequency	$R_L = 2\text{ k}\Omega$, $C_L = 20\text{ pF}$		7.5		MHz
GBW	Gain Bandwidth	$f = 50\text{ kHz}$		16		MHz
e_n	Input Referred Voltage Noise Density	$f = 2\text{ kHz}$		11.9		nV/ $\sqrt{\text{Hz}}$
i_n	Input Referred Current Noise Density	$f = 2\text{ kHz}$		0.5		pA/ $\sqrt{\text{Hz}}$
THD+N	Total Harmonic Distortion + Noise	$V^+ = 1.9\text{V}$, $V^- = -0.8\text{V}$ $f = 1\text{ kHz}$, $R_L = 100\text{ k}\Omega$, $A_V = +2$ $V_{OUT} = 210\text{ mV}_{PP}$		-77		dB
CT Rej.	Crosstalk Rejection	$f = 100\text{ kHz}$, Driver $R_L = 10\text{ k}\Omega$		60		dB

$\pm 5\text{V}$ Electrical Characteristics (Note 5)

Unless otherwise specified, all limited guaranteed for $T_A = 25^\circ\text{C}$, $V^+ = 5\text{V}$, $V^- = -5\text{V}$, $V_{CM} = 0\text{V}$, $V_{OUT} = 0\text{V}$, and $R_L > 1\text{ M}\Omega$ to 0V . **Boldface** limits apply at the temperature extremes.

Symbol	Parameter	Condition	Min (Note 7)	Typ (Note 6)	Max (Note 7)	Units
V_{OS}	Input Offset Voltage	$V_{CM} = -4.5\text{V}$ and $V_{CM} = 4.5\text{V}$	-5 -6	± 0.7	+5 +6	mV
TC V_{OS}	Input Offset Voltage Temperature Drift	$V_{CM} = -4.5\text{V}$ and $V_{CM} = 4.5\text{V}$ (Note 8)		± 2		$\mu\text{V}/^\circ\text{C}$
I_B	Input Bias Current	$V_{CM} = -4.5\text{V}$ (Note 9)	-2.0 -2.5	-1.2		μA
		$V_{CM} = 4.5\text{V}$ (Note 9)		0.45	1.0 1.5	
I_{OS}	Input Offset Current	$V_{CM} = -4.5\text{V}$ and $V_{CM} = 4.5\text{V}$		20	200 300	nA
CMRR	Common Mode Rejection Ratio	$-5\text{V} \leq V_{CM} \leq 3\text{V}$	80 70	100		dB
		$-5\text{V} \leq V_{CM} \leq 5\text{V}$	65 62	80		
PSRR	Power Supply Rejection Ratio	$2.7\text{V} \leq V_S \leq 30\text{V}$, $V_{CM} = -4.5\text{V}$	78 74	104		dB
CMVR	Common Mode Voltage Range	CMRR > 50 dB		-5.3	-5.1 -5.0	V
			5.1 5.0	5.3		
A_{VOL}	Open Loop Voltage Gain	$-4\text{V} \leq V_O \leq 4\text{V}$ $R_L = 10\text{ k}\Omega$ to 0V	74 70	80		dB
		$-4\text{V} \leq V_O \leq 4\text{V}$ $R_L = 2\text{ k}\Omega$ to 0V	68 65	74		

Symbol	Parameter	Condition	Min (Note 7)	Typ (Note 6)	Max (Note 7)	Units
V_{OUT}	Output Voltage Swing High	$R_L = 10\text{ k}\Omega$ to 0V $V_{ID} = 100\text{ mV}$		100	250 280	mV from either rail
		$R_L = 2\text{ k}\Omega$ to 0V $V_{ID} = 100\text{ mV}$		160	350 450	
	Output Voltage Swing Low	$R_L = 10\text{ k}\Omega$ to 0V $V_{ID} = -100\text{ mV}$		35	200 250	
		$R_L = 2\text{ k}\Omega$ to 0V $V_{ID} = -100\text{ mV}$		80	200 250	
I_{OUT}	Output Current	Sourcing $V_{ID} = 200\text{ mV}$, $V_{OUT} = -5\text{V}$ (Note 3)	35 20	70		mA
		Sinking $V_{ID} = -200\text{ mV}$, $V_{OUT} = 5\text{V}$ (Note 3)	50 30	85		
I_S	Supply Current	$V_{CM} = -4.5\text{V}$	LM7321	1.0	1.3 2	mA
			LM7322	2.3	2.8 3.8	
SR	Slew Rate (Note 10)	$A_V = +1$, $V_I = 8\text{V}$ Step		12.3		V/ μs
f_u	Unity Gain Frequency	$R_L = 2\text{ k}\Omega$, $C_L = 20\text{ pF}$		9		MHz
GBW	Gain Bandwidth	$f = 50\text{ kHz}$		16		MHz
e_n	Input Referred Voltage Noise Density	$f = 2\text{ kHz}$		14.3		nV/ $\sqrt{\text{Hz}}$
i_n	Input Referred Current Noise Density	$f = 2\text{ kHz}$		1.35		pA/ $\sqrt{\text{Hz}}$
THD+N	Total Harmonic Distortion + Noise	$f = 1\text{ kHz}$, $R_L = 100\text{ k}\Omega$, $A_V = +2$ $V_{OUT} = 8\text{ V}_{PP}$		-79		dB
CT Rej.	Crosstalk Rejection	$f = 100\text{ kHz}$, Driver $R_L = 10\text{ k}\Omega$		60		dB

$\pm 15\text{V}$ Electrical Characteristics (Note 5)

Unless otherwise specified, all limited guaranteed for $T_A = 25^\circ\text{C}$, $V_+ = 15\text{V}$, $V_- = -15\text{V}$, $V_{CM} = 0\text{V}$, $V_{OUT} = 0\text{V}$, and $R_L > 1\text{M}\Omega$ to 15V. **Boldface** limits apply at the temperature extremes.

Symbol	Parameter	Condition	Min (Note 7)	Typ (Note 6)	Max (Note 7)	Units
V_{OS}	Input Offset Voltage	$V_{CM} = -14.5\text{V}$ and $V_{CM} = 14.5\text{V}$	-6 -8	± 0.7	+6 +8	mV
TC V_{OS}	Input Offset Voltage Temperature Drift	$V_{CM} = -14.5\text{V}$ and $V_{CM} = 14.5\text{V}$ (Note 8)		± 2		$\mu\text{V}/^\circ\text{C}$
I_B	Input Bias Current	$V_{CM} = -14.5\text{V}$ (Note 9)	-2 -2.5	-1.1		μA
		$V_{CM} = 14.5\text{V}$ (Note 9)		0.45	1.0 1.5	
I_{OS}	Input Offset Current	$V_{CM} = -14.5\text{V}$ and $V_{CM} = 14.5\text{V}$		30	300 500	nA
CMRR	Common Mode Rejection Ratio	$-15\text{V} \leq V_{CM} \leq 12\text{V}$	80 75	100		dB
		$-15\text{V} \leq V_{CM} \leq 15\text{V}$	72 70	80		
PSRR	Power Supply Rejection Ratio	$2.7\text{V} \leq V_S \leq 30\text{V}$, $V_{CM} = -14.5\text{V}$	78 74	100		dB
CMVR	Common Mode Voltage Range	CMRR > 50 dB		-15.3	-15.1 -15	V
			15.1 15	15.3		

Symbol	Parameter	Condition	Min (Note 7)	Typ (Note 6)	Max (Note 7)	Units
A _{VOL}	Open Loop Voltage Gain	-13V ≤ V _O ≤ 13V R _L = 10 kΩ to 0V	75 70	85		dB
		-13V ≤ V _O ≤ 13V R _L = 2 kΩ to 0V	70 65	78		
V _{OUT}	Output Voltage Swing High	R _L = 10 kΩ to 0V V _{ID} = 100 mV		150	300 350	mV from either rail
		R _L = 2 kΩ to 0V V _{ID} = 100 mV		250	550 650	
	Output Voltage Swing Low	R _L = 10 kΩ to 0V V _{ID} = -100 mV		60	200 250	
		R _L = 2 kΩ to 0V V _{ID} = -100 mV		130	300 400	
I _{OUT}	Output Current	Sourcing V _{ID} = 200 mV, V _{OUT} = -15V (Note 3)	40	65		mA
		Sinking V _{ID} = -200 mV, V _{OUT} = 15V (Note 3)	60	100		
I _S	Supply Current	V _{CM} = -14.5V	LM7321	1.1	1.7 2.4	mA
			LM7322	2.5	4 5.6	
SR	Slew Rate (Note 10)	A _V = +1, V _I = 20V Step		18		V/μs
f _u	Unity Gain Frequency	R _L = 2 kΩ, C _L = 20 pF		11.3		MHz
GBW	Gain Bandwidth	f = 50 kHz		20		MHz
e _n	Input Referred Voltage Noise Density	f = 2 kHz		15		nV/√Hz
i _n	Input Referred Current Noise Density	f = 2 kHz		1.3		pA/√Hz
THD+N	Total Harmonic Distortion +Noise	f = 1 kHz, R _L 100 kΩ, A _V = +2, V _{OUT} = 23 V _{PP}		-86		dB
CT Rej.	Crosstalk Rejection	f = 100 kHz, Driver R _L = 10 kΩ		60		dB

Note 1: Absolute Maximum Ratings indicate limits beyond which damage to the device may occur. Operating Rating indicate conditions for which the device is intended to be functional, but specific performance is not guaranteed. For guaranteed specifications and the test conditions, see the Electrical Characteristics.

Note 2: Human Body Model, applicable std. MIL-STD-883, Method 3015.7. Machine Model, applicable std. JESD22-A115-A (ESD MM std. of JEDEC) Field-Induced Charge-Device Model, applicable std. JESD22-C101-C (ESD FICDM std. of JEDEC).

Note 3: Applies to both single-supply and split-supply operation. Continuous short circuit operation at elevated ambient temperature can result in exceeding the maximum allowed junction temperature of 150°C. Short circuit test is a momentary test. Output short circuit duration is infinite for V_S ≤ 6V at room temperature and below. For V_S > 6V, allowable short circuit duration is 1.5 ms.

Note 4: The maximum power dissipation is a function of T_{J(MAX)}, θ_{JA}. The maximum allowable power dissipation at any ambient temperature is P_D = (T_{J(MAX)} - T_A) / θ_{JA}. All numbers apply for packages soldered directly onto a PC board.

Note 5: Electrical Table values apply only for factory testing conditions at the temperature indicated. Factory testing conditions result in very limited self-heating of the device such that T_J = T_A. No guarantee of parametric performance is indicated in the electrical tables under conditions of internal self-heating where T_J > T_A.

Note 6: Typical values represent the most likely parametric norm as determined at the time of characterization. Actual typical values may vary over time and will also depend on the application and configuration. The typical values are not tested and are not guaranteed on shipped production material.

Note 7: All limits are guaranteed by testing or statistical analysis.

Note 8: Offset voltage temperature drift determined by dividing the change in V_{OS} at temperature extremes into the total temperature change.

Note 9: Positive current corresponds to current flowing into the device.

Note 10: Slew rate is the slower of the rising and falling slew rates. Connected as a Voltage Follower.

Connection Diagrams

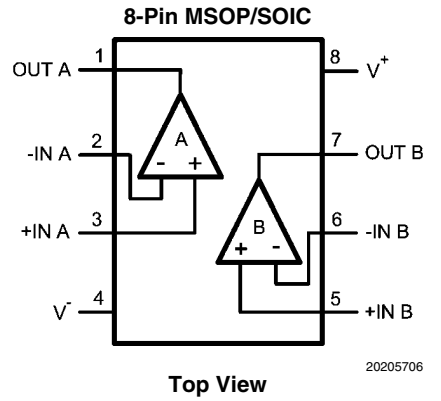
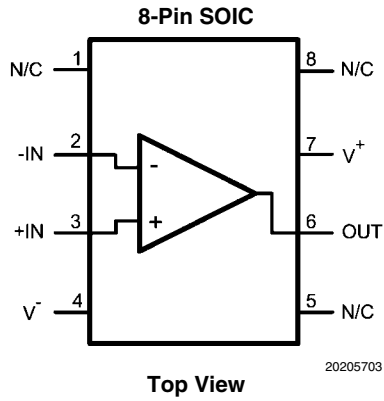
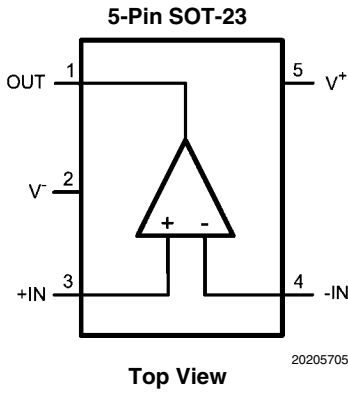

Ordering Information

Package	Part Number	Package Marking	Media Transport	NSC Drawing
5-Pin SOT-23	LM7321MF	AU4A	1k Units Tape and Reel	MF05A
	LM7321MFE		250 Units Tape and Reel	
	LM7321MFX		3k Units Tape and Reel	
8-Pin MSOP	LM7322MM	AZ4A	1k Units Tape and Reel	MUA08A
	LM7322MME		250 Units Tape and Reel	
	LM7322MMX		3.5k Units Tape and Reel	
8-Pin SOIC	LM7321MA	LM7321MA	95 Units/Rail	M08A
	LM7321MAX	LM7321MA	2.5k Units Tape and Reel	
	LM7322MA	LM7322MA	95 Units/Rail	
	LM7322MAX	LM7322MA	2.5k Units Tape and Reel	

Typical Performance Characteristics Unless otherwise specified: $T_A = 25^\circ\text{C}$.

Output Swing vs. Sourcing Current

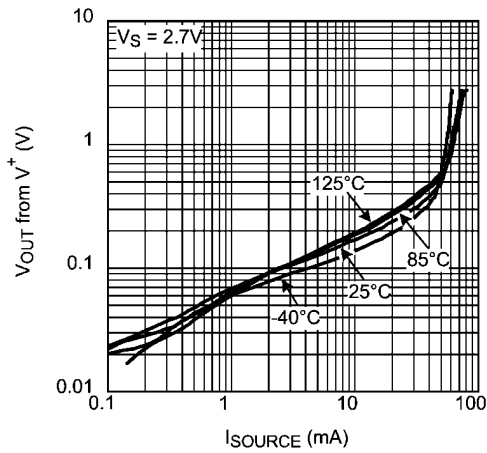

20205734

Output Swing vs. Sinking Current

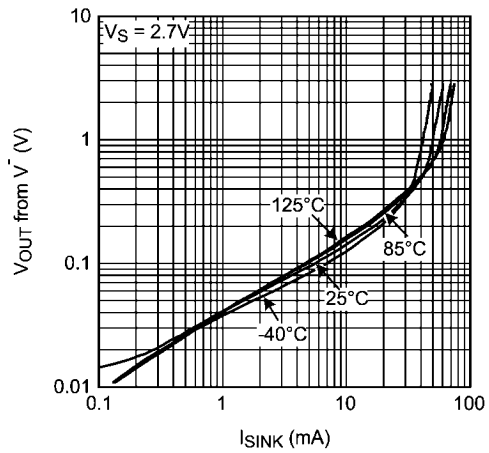

20205731

Output Swing vs. Sourcing Current

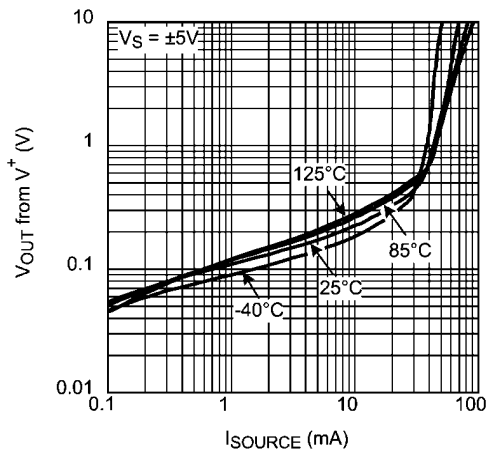

20205735

Output Swing vs. Sinking Current

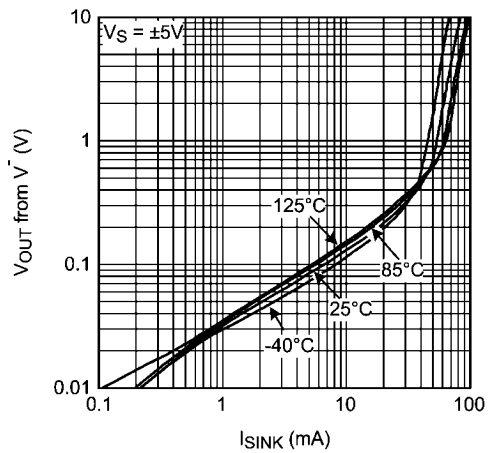

20205732

Output Swing vs. Sourcing Current

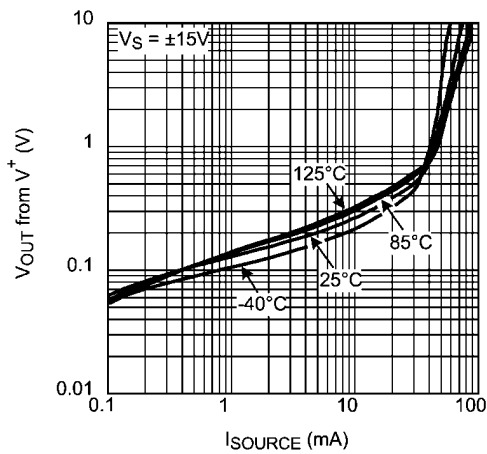

20205736

Output Swing vs. Sinking Current

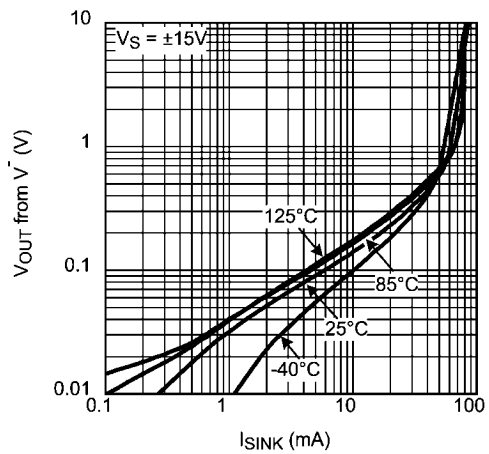

20205733

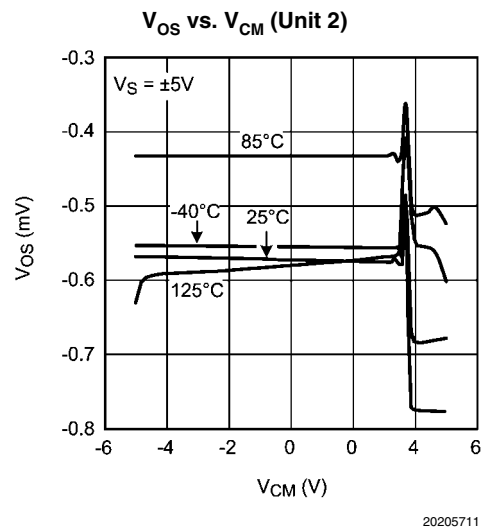
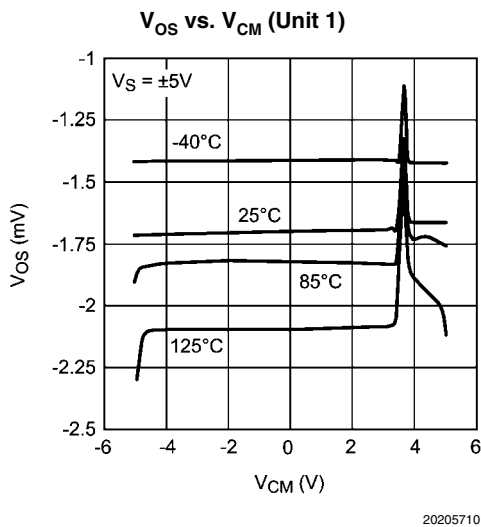
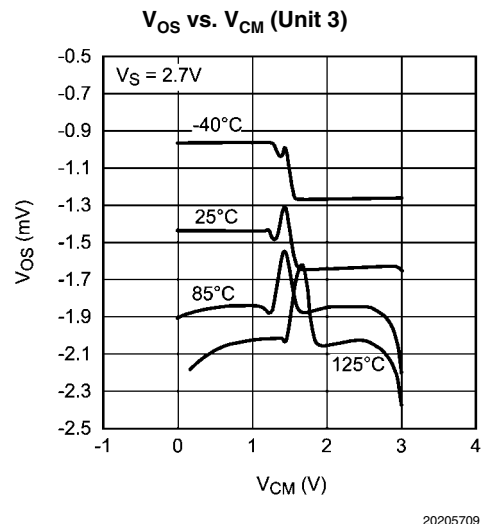
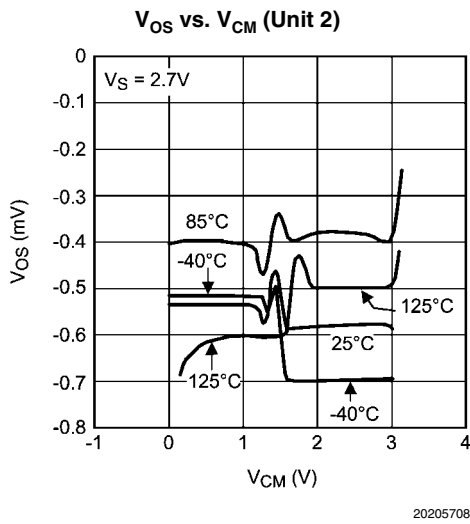
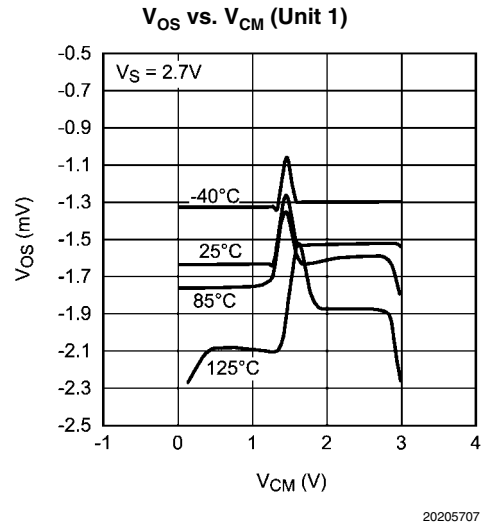
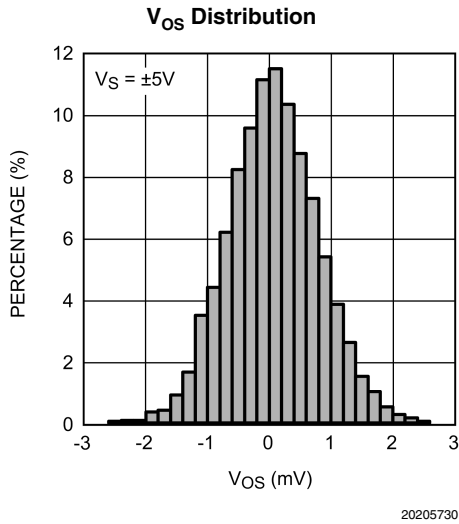

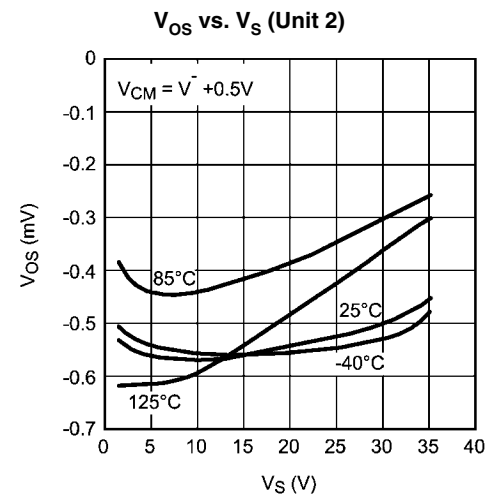
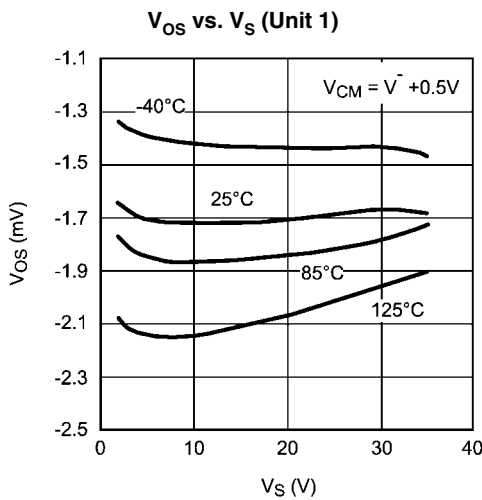
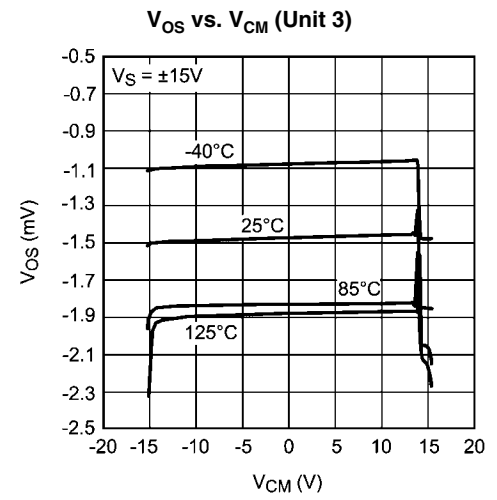
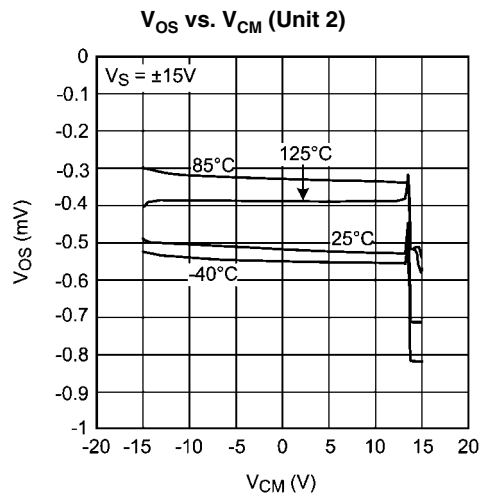
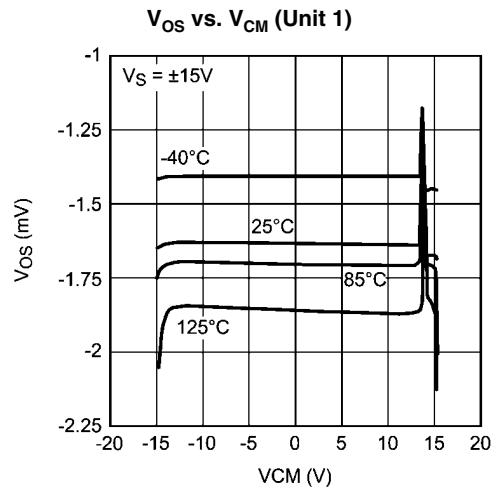
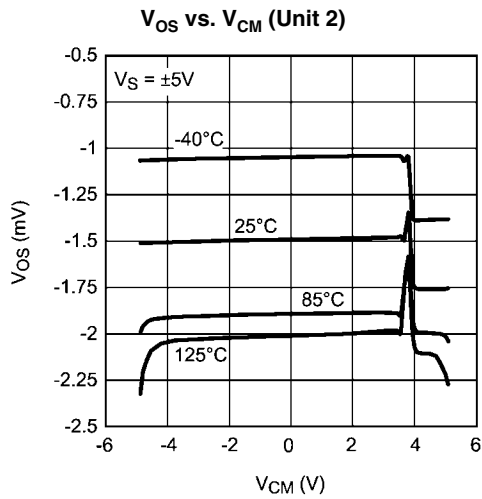

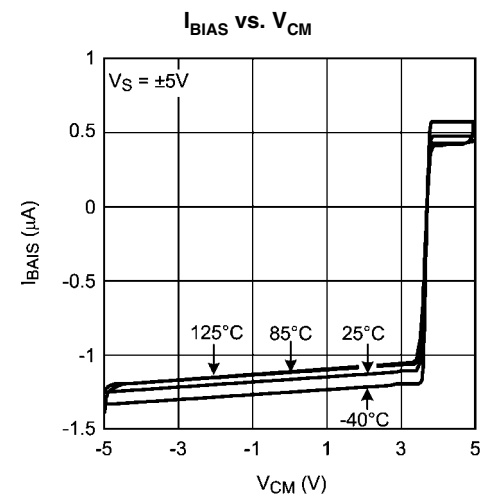
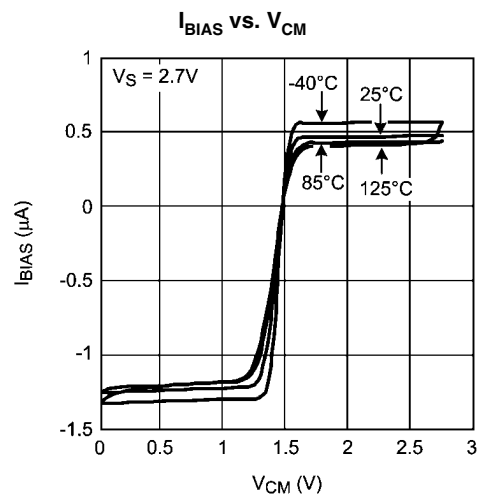
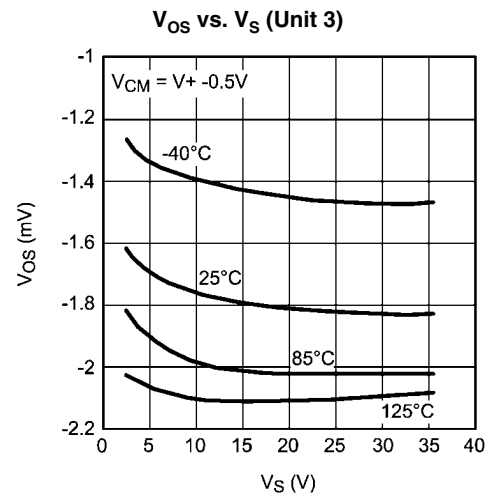
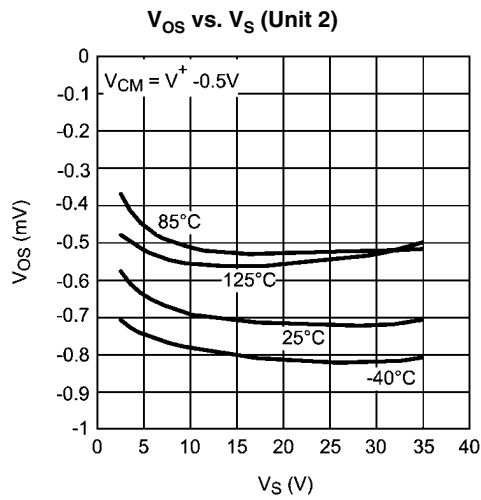
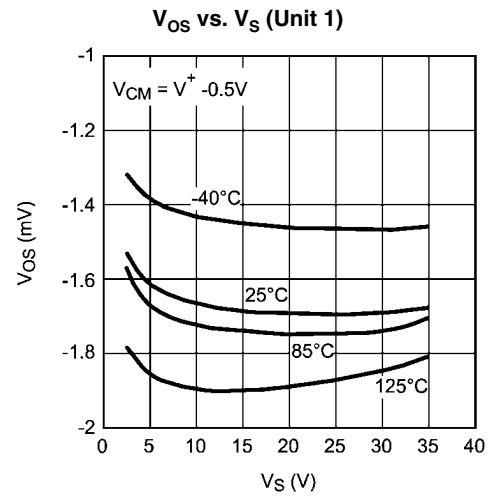
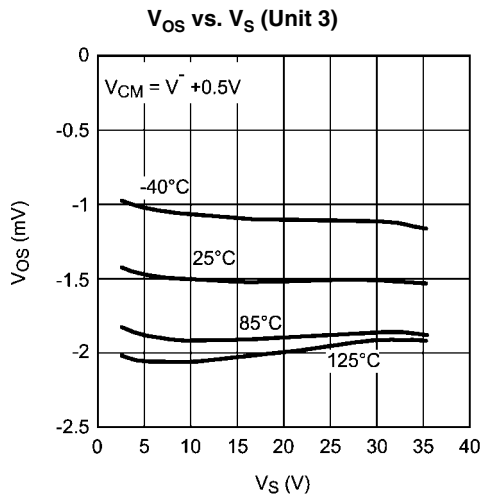

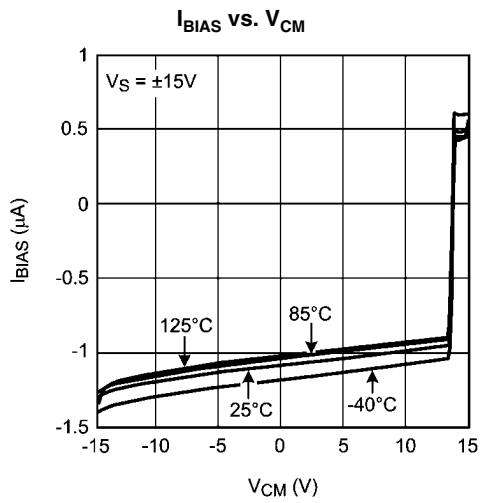

20205725

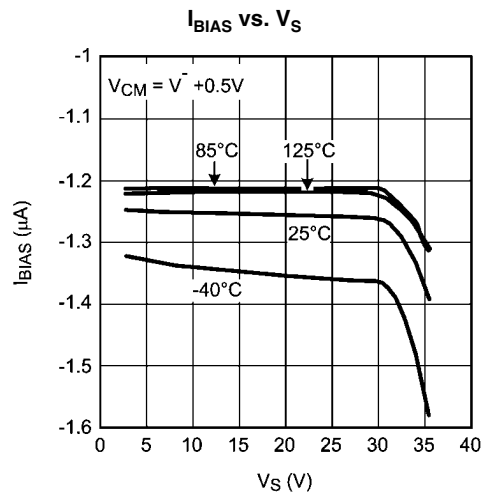

20205722

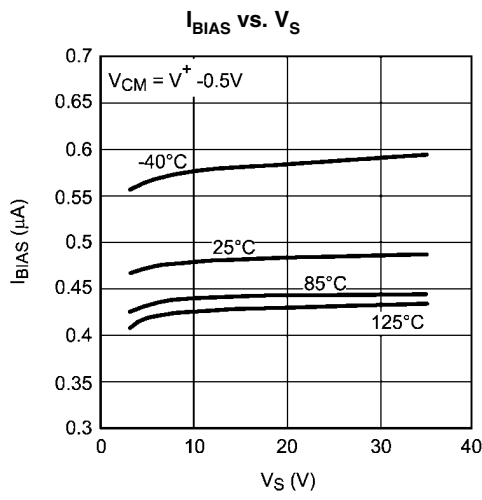

20205721

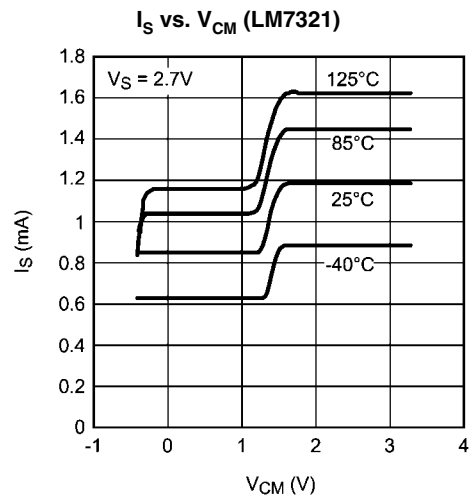

20205718

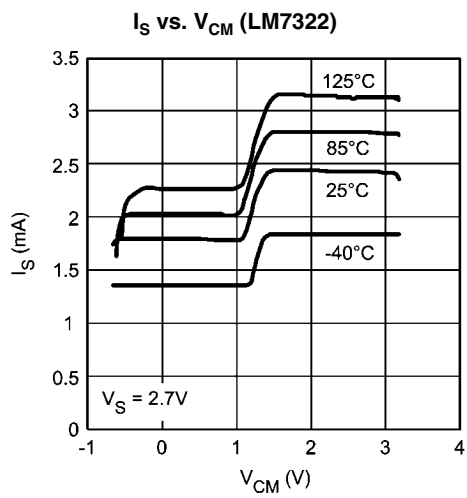

20205775

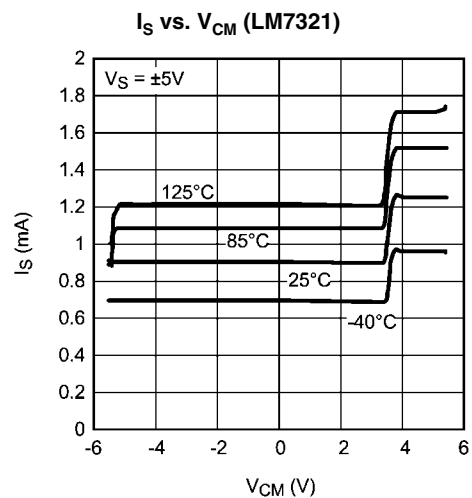

20205719

I_S vs. V_{CM} (LM7322)

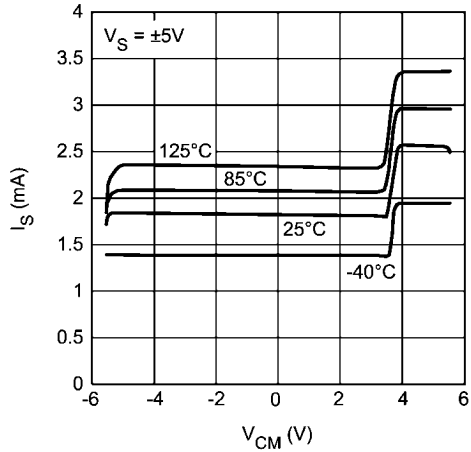

I_S vs. V_{CM} (LM7321)

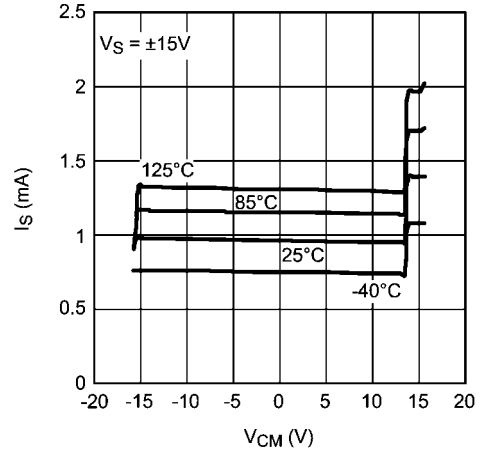

I_S vs. V_{CM} (LM7322)

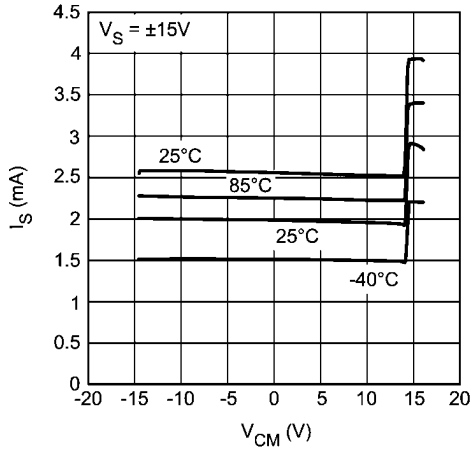

I_S vs. V_S (LM7321)

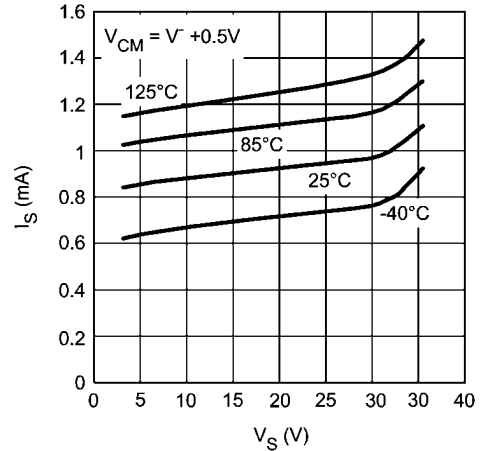

I_S vs. V_S (LM7322)

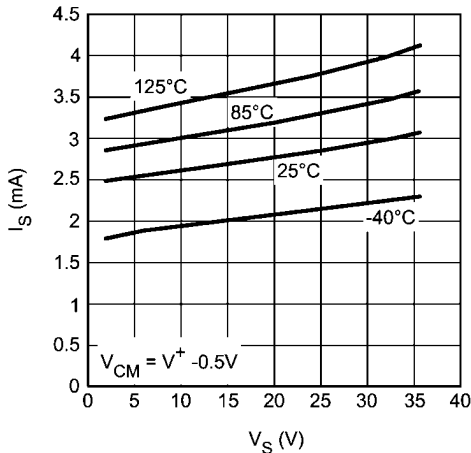

I_S vs. V_S (LM7321)

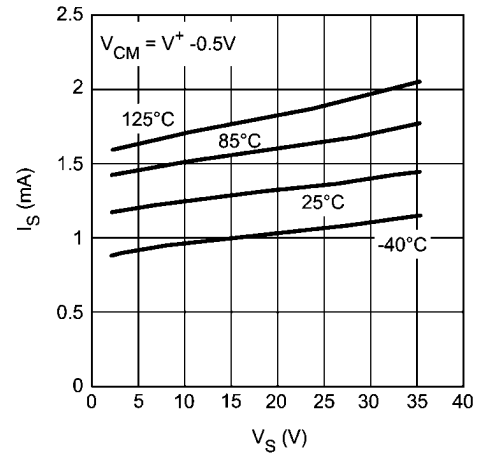

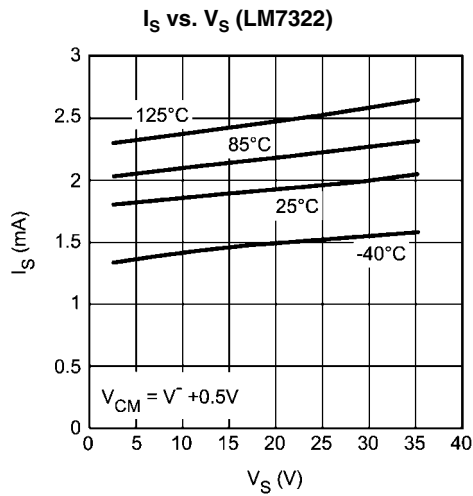

20205778

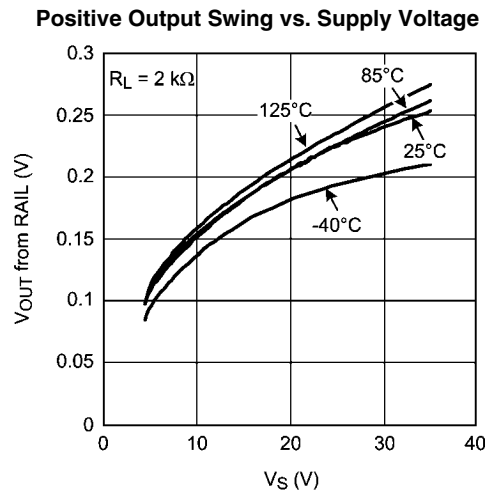

20205727

Positive Output Swing vs. Supply Voltage

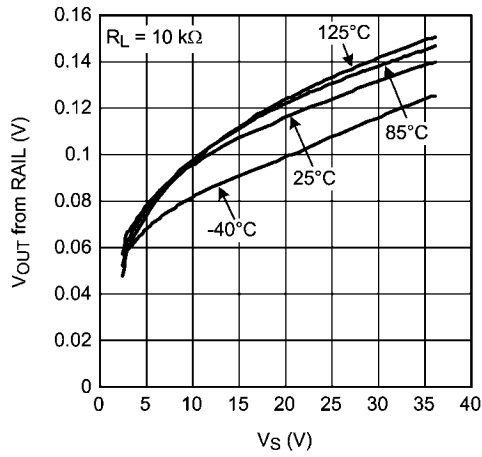

20205726

Negative Output Swing vs. Supply Voltage

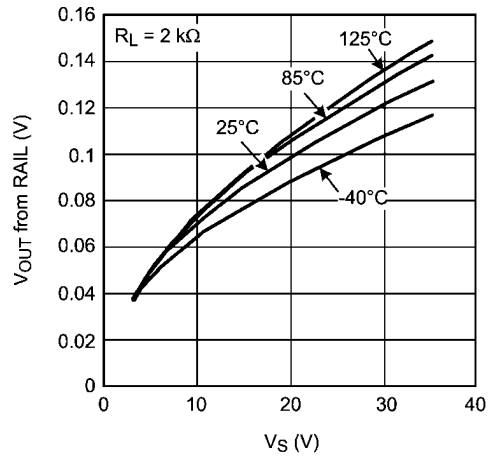

20205728

Negative Output Swing vs. Supply Voltage

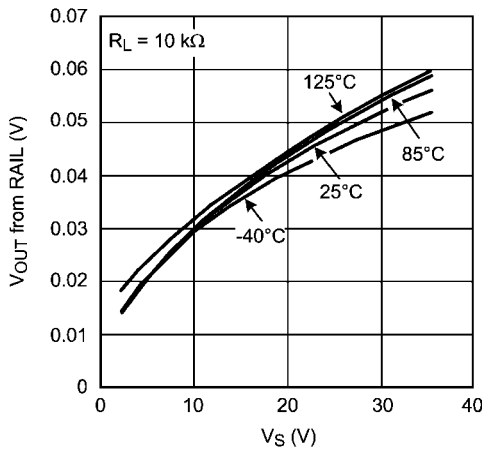

20205729

Open Loop Frequency Response with Various Capacitive Load

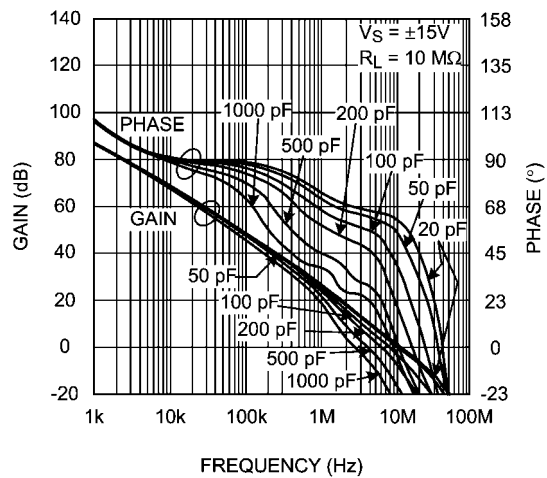

20205782

Open Loop Frequency Response with Various Resistive Load

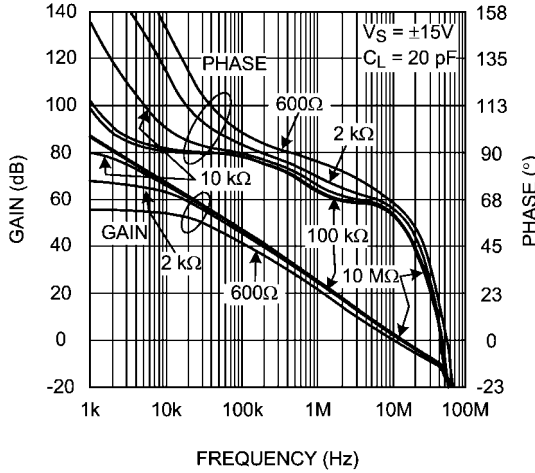

20205783

Open Loop Frequency Response with Various Supply Voltage

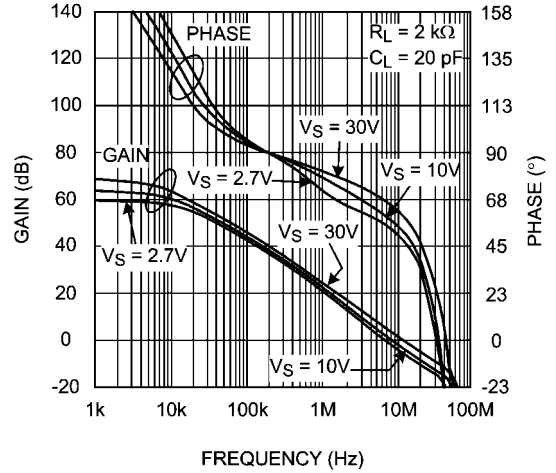

20205784

Phase Margin vs. Capacitive Load

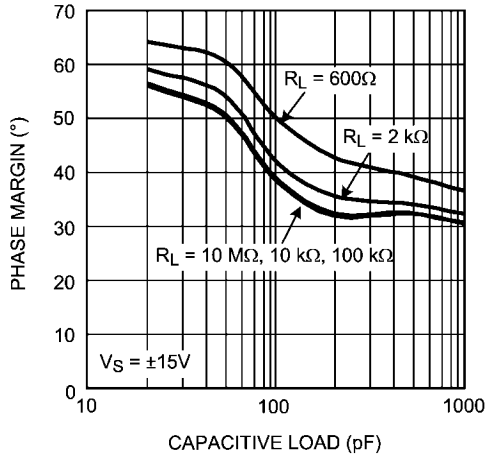

20205738

CMRR vs. Frequency

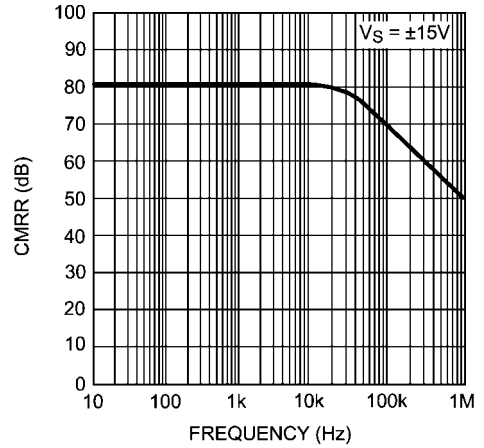

20205739

+PSRR vs. Frequency

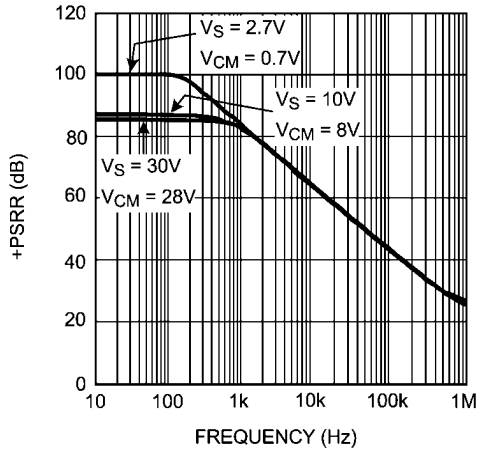

20205740

-PSRR vs. Frequency

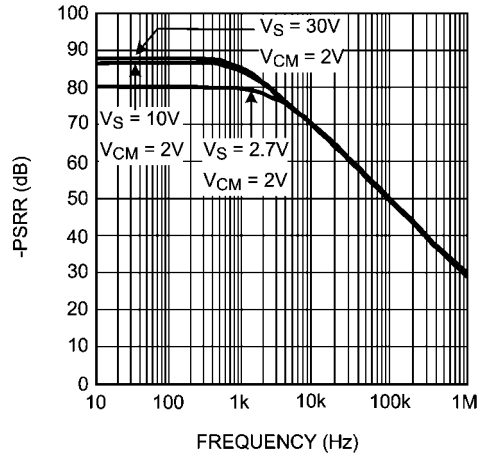

20205741

Small Signal Step Response

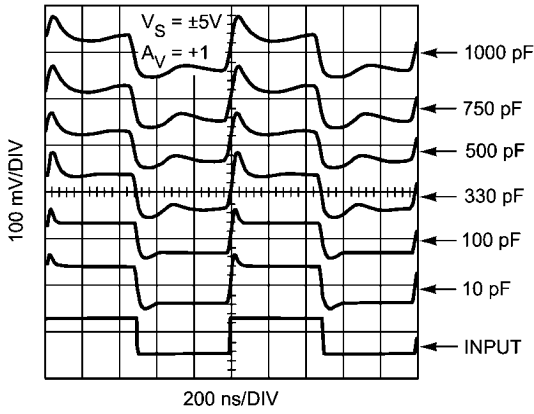

20205737

Large Signal Step Response

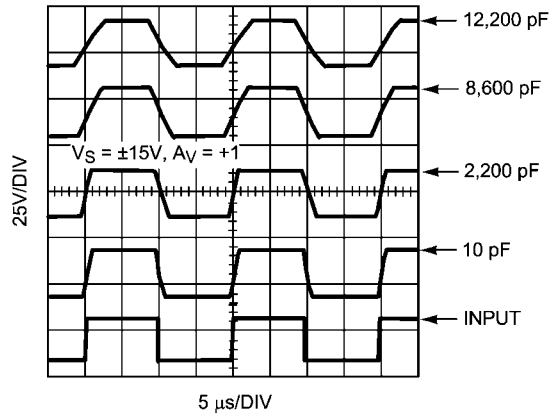

20205749

Input Referred Noise Density vs. Frequency

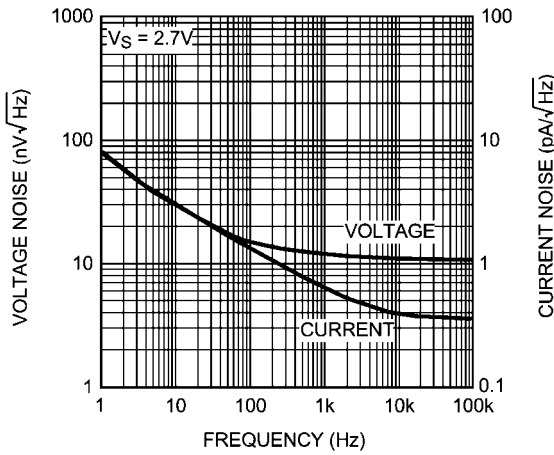

20205742

Input Referred Noise Density vs. Frequency

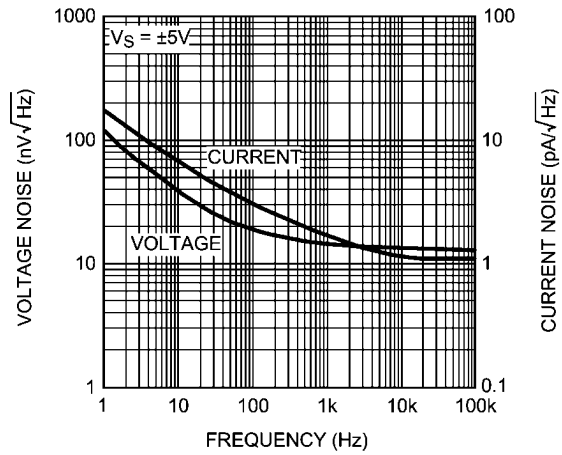

20205743

Input Referred Noise Density vs. Frequency

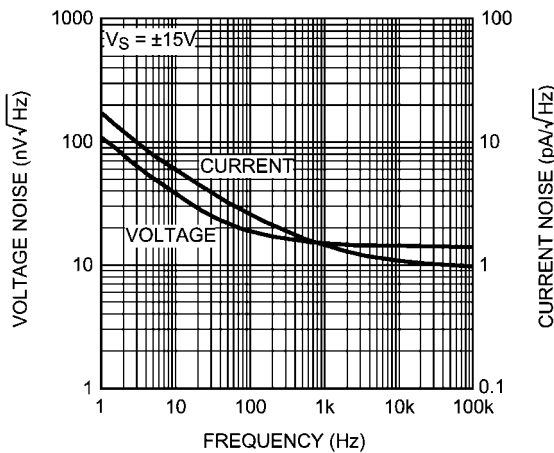

20205744

THD+N vs. Frequency

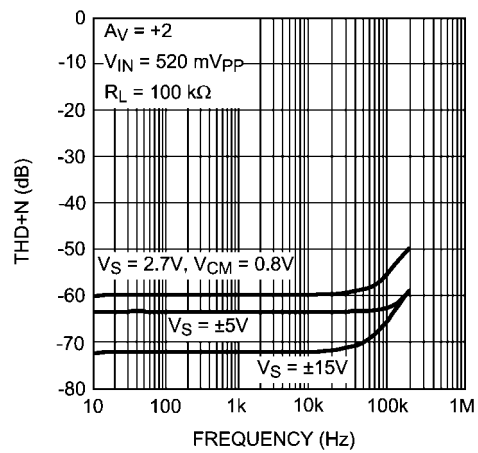

20205745

THD+N vs. Output Amplitude

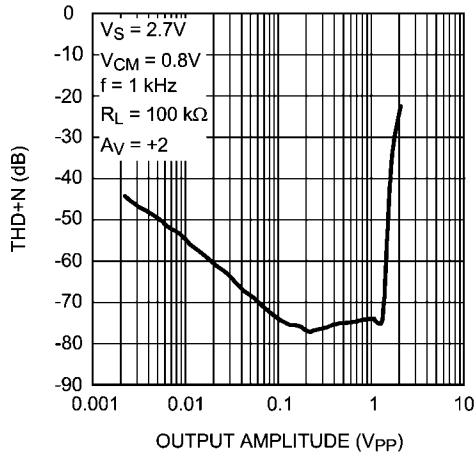

20205746

THD+N vs. Output Amplitude

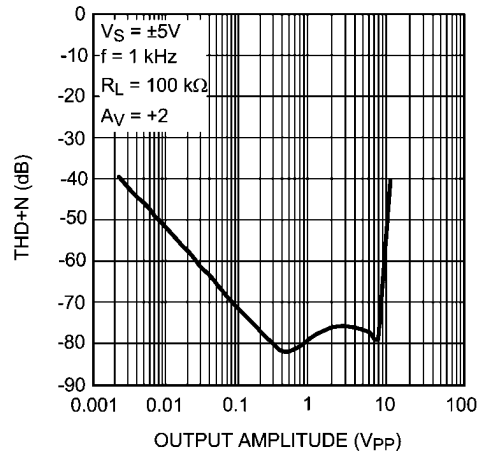

20205747

THD+N vs. Output Amplitude

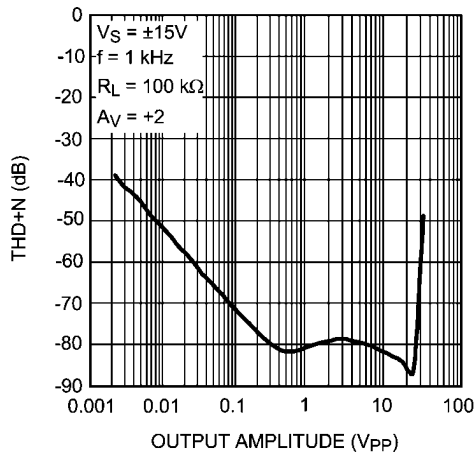

20205748

Crosstalk Rejection vs. Frequency

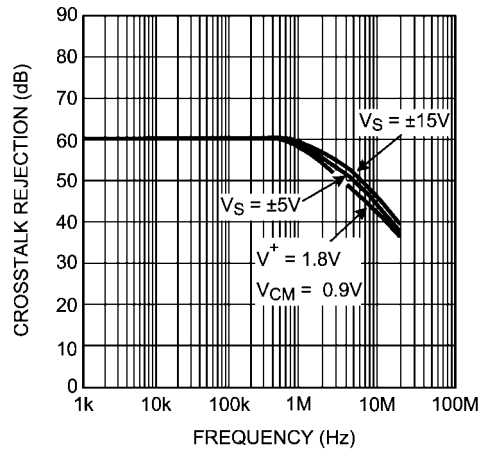

20205768

Application Information

DRIVING CAPACITIVE LOADS

The LM7321/LM7322 are specifically designed to drive unlimited capacitive loads without oscillations as shown in Figure 1.

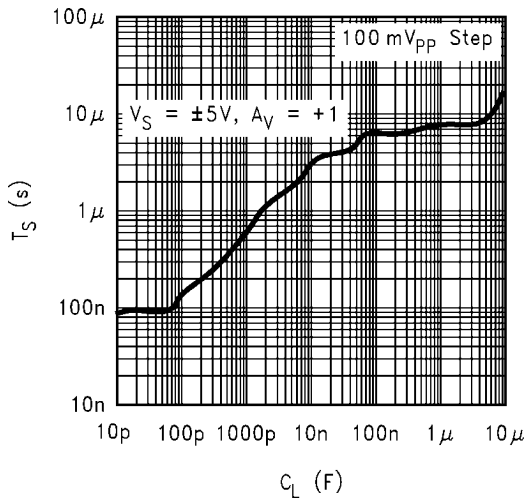

20205769

FIGURE 1. $\pm 5\%$ Settling Time vs. Capacitive Load

In addition, the output current handling capability of the device allows for good slewing characteristics even with large capacitive loads as shown in Figure 2 and Figure 3.

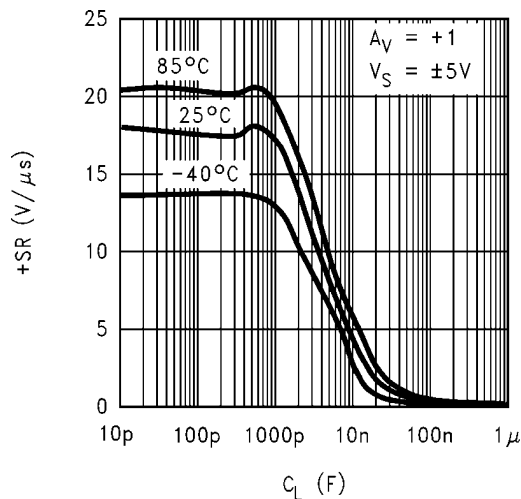

20205770

FIGURE 2. $+SR$ vs. Capacitive Load

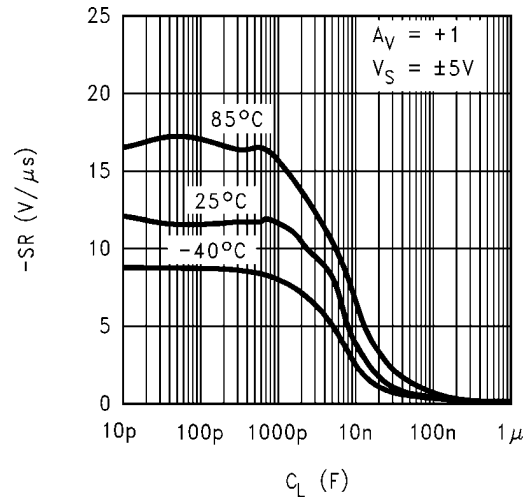

20205771

FIGURE 3. $-SR$ vs. Capacitive Load

The combination of these features is ideal for applications such as TFT flat panel buffers, A/D converter input amplifiers, etc.

However, as in most op amps, addition of a series isolation resistor between the op amp and the capacitive load improves the settling and overshoot performance.

Output current drive is an important parameter when driving capacitive loads. This parameter will determine how fast the output voltage can change. Referring to the Slew Rate vs. Capacitive Load Plots (typical performance characteristics section), two distinct regions can be identified. Below about 10,000 pF, the output Slew Rate is solely determined by the op amp's compensation capacitor value and available current into that capacitor. Beyond 10 nF, the Slew Rate is determined by the op amp's available output current. Note that because of the lower output sourcing current compared to the sinking one, the Slew Rate limit under heavy capacitive loading is determined by the positive transitions. An estimate of positive and negative slew rates for loads larger than 100 nF can be made by dividing the short circuit current value by the capacitor.

For the LM7321/LM7322, the available output current increases with the input overdrive. Referring to Figure 4 and Figure 5, Output Short Circuit Current vs. Input Overdrive, it can be seen that both sourcing and sinking short circuit current increase as input overdrive increases. In a closed loop amplifier configuration, during transient conditions while the fed back output has not quite caught up with the input, there will be an overdrive imposed on the input allowing more output current than would normally be available under steady state condition. Because of this feature, the op amp's output stage quiescent current can be kept to a minimum, thereby reducing power consumption, while enabling the device to deliver large output current when the need arises (such as during transients).

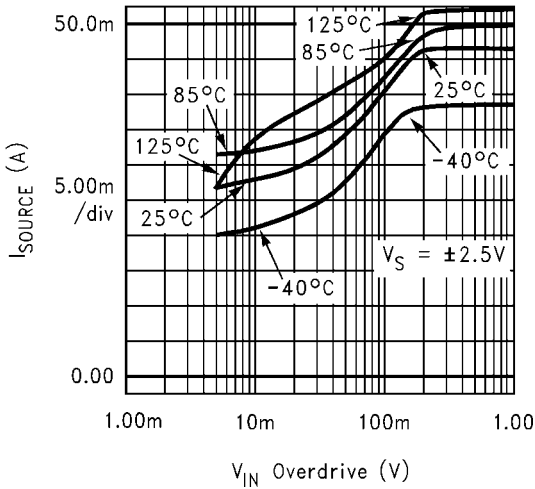

FIGURE 4. Output Short Circuit Sourcing Current vs. Input Overdrive

20205772

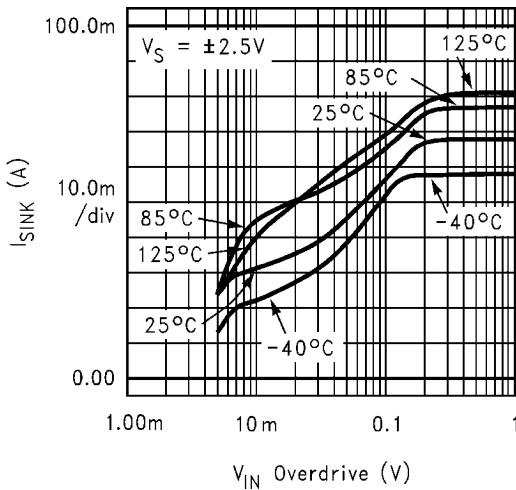

FIGURE 5. Output Short Circuit Sinking Current vs. Input Overdrive

20205773

Figure 6 shows the output voltage, output current, and the resulting input overdrive with the device set for $A_V = +1$ and the input tied to a $1 V_{PP}$ step function driving a $47 nF$ capacitor. As can be seen, during the output transition, the input overdrive reaches $1V$ peak and is more than enough to cause the output current to increase to its maximum value (see Figure 4 and Figure 5 plots). Note that because of the larger output sinking current compared to the sourcing one, the output negative transition is faster than the positive one.

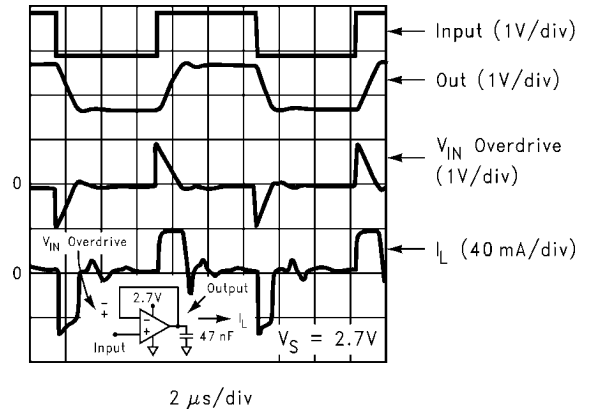

FIGURE 6. Buffer Amplifier Scope Photo

20205774

ESTIMATING THE OUTPUT VOLTAGE SWING

It is important to keep in mind that the steady state output current will be less than the current available when there is an input overdrive present. For steady state conditions, the Output Voltage vs. Output Current plot (Typical Performance Characteristics section) can be used to predict the output swing. Figure 7 and Figure 8 show this performance along with several load lines corresponding to loads tied between the output and ground. In each cases, the intersection of the device plot at the appropriate temperature with the load line would be the typical output swing possible for that load. For example, a $1 k\Omega$ load can accommodate an output swing to within $250 mV$ of V_- and to $330 mV$ of V_+ ($V_S = \pm 15V$) corresponding to a typical $29.3 V_{PP}$ unclipped swing.

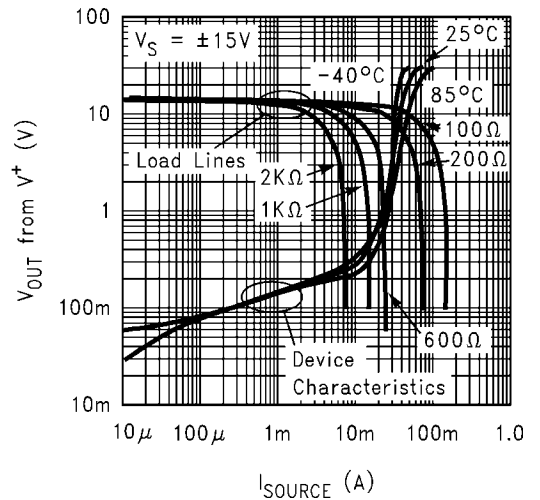

FIGURE 7. Output Sourcing Characteristics with Load Lines

20205756

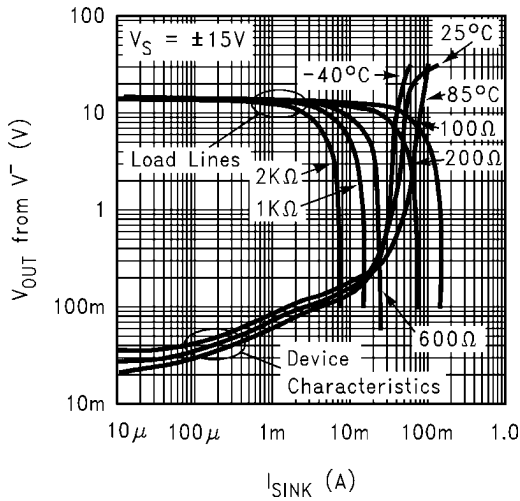

FIGURE 8. Output Sinking Characteristics with Load Lines

SETTLING TIME WITH LARGE CAPACITIVE LOADS

Figure 9 below, shows a typical application where the LM7321/LM7322 is used as a buffer amplifier for the V_{COM} signal employed in a TFT LCD flat panel:

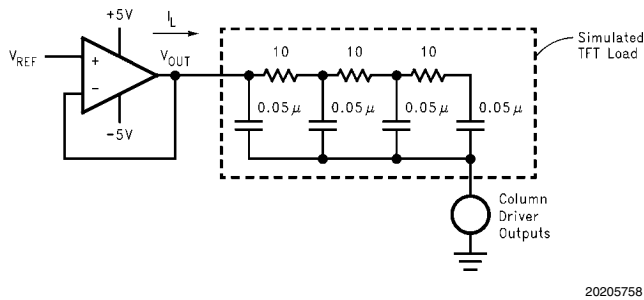

FIGURE 9. V_{COM} Driver Application Schematic

Figure 10 shows the time domain response of the amplifier when used as a V_{COM} buffer/driver with V_{REF} at ground. In this application, the op amp loop will try and maintain its output voltage based on the voltage on its non-inverting input (V_{REF}) despite the current injected into the TFT simulated load. As long as this load current is within the range tolerable by the LM7321/LM7322 (45 mA sourcing and 65 mA sinking for ±5V supplies), the output will settle to its final value within less than 2 μs.

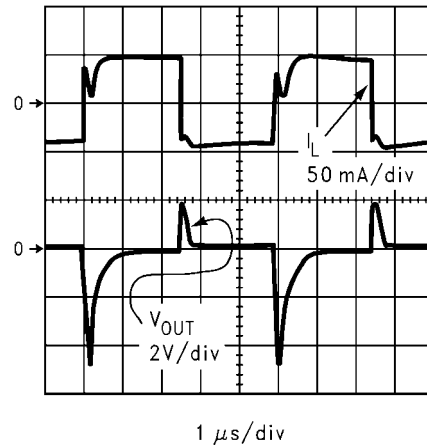

FIGURE 10. V_{COM} Driver Performance Scope Photo

OUTPUT SHORT CIRCUIT CURRENT AND DISSIPATION ISSUES

The LM7321/LM7322 output stage is designed for maximum output current capability. Even though momentary output shorts to ground and either supply can be tolerated at all operating voltages, longer lasting short conditions can cause the junction temperature to rise beyond the absolute maximum rating of the device, especially at higher supply voltage conditions. Below supply voltage of 6V, the output short circuit condition can be tolerated indefinitely.

With the op amp tied to a load, the device power dissipation consists of the quiescent power due to the supply current flow into the device, in addition to power dissipation due to the load current. The load portion of the power itself could include an average value (due to a DC load current) and an AC component. DC load current would flow if there is an output voltage offset, or the output AC average current is non-zero, or if the op amp operates in a single supply application where the output is maintained somewhere in the range of linear operation. Therefore:

$$P_{TOTAL} = P_Q + P_{DC} + P_{AC}$$

$$P_Q = I_S \cdot V_S$$

Op Amp Quiescent Power
Dissipation

$$P_{DC} = I_O \cdot (V_r - V_o)$$

DC Load Power

$$P_{AC} = \text{See Table 1 below}$$

AC Load Power

where:

I_S: Supply Current

V_S: Total Supply Voltage (V⁺ – V⁻)

V_O: Average Output Voltage

V_r: V⁺ for sourcing and V⁻ for sinking current

Table 1 below shows the maximum AC component of the load power dissipated by the op amp for standard Sinusoidal, Triangular, and Square Waveforms:

TABLE 1. Normalized AC Power Dissipated in the Output Stage for Standard Waveforms

$P_{AC} (W \cdot \Omega / V^2)$		
Sinusoidal	Triangular	Square
50.7×10^{-3}	46.9×10^{-3}	62.5×10^{-3}

The table entries are normalized to V_S^2/R_L . To figure out the AC load current component of power dissipation, simply multiply the table entry corresponding to the output waveform by the factor V_S^2/R_L . For example, with $\pm 12V$ supplies, a 600Ω load, and triangular waveform power dissipation in the output stage is calculated as:

$$P_{AC} = (46.9 \times 10^{-3}) \cdot [242/600] = 45.0 \text{ mW}$$

The maximum power dissipation allowed at a certain temperature is a function of maximum die junction temperature ($T_{J(MAX)}$) allowed, ambient temperature T_A , and package thermal resistance from junction to ambient, θ_{JA} .

$$P_{D(MAX)} = \frac{T_{J(MAX)} - T_A}{\theta_{JA}}$$

For the LM7321/LM7322, the maximum junction temperature allowed is 150°C at which no power dissipation is allowed. The power capability at 25°C is given by the following calculations:

For MSOP package:

$$P_{D(MAX)} = \frac{150^\circ\text{C} - 25^\circ\text{C}}{235^\circ\text{C/W}} = 0.53\text{W}$$

For SOIC package:

$$P_{D(MAX)} = \frac{150^\circ\text{C} - 25^\circ\text{C}}{165^\circ\text{C/W}} = 0.76\text{W}$$

Similarly, the power capability at 125°C is given by:

For MSOP package:

$$P_{D(MAX)} = \frac{150^\circ\text{C} - 125^\circ\text{C}}{235^\circ\text{C/W}} = 0.11\text{W}$$

For SOIC package:

$$P_{D(MAX)} = \frac{150^\circ\text{C} - 125^\circ\text{C}}{165^\circ\text{C/W}} = 0.15\text{W}$$

Figure 11 shows the power capability vs. temperature for MSOP and SOIC packages. The area under the maximum thermal capability line is the operating area for the device. When the device works in the operating area where P_{TOTAL} is less than $P_{D(MAX)}$, the device junction temperature will remain below 150°C . If the intersection of ambient temperature and package power is above the maximum thermal capability line, the junction temperature will exceed 150°C and this should be strictly prohibited.

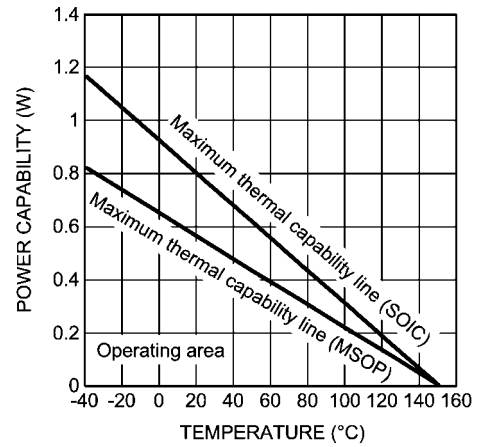

20205765

FIGURE 11. Power Capability vs. Temperature

When high power is required and ambient temperature can't be reduced, providing air flow is an effective approach to reduce thermal resistance therefore to improve power capability.

Other Application Hints

The use of supply decoupling is mandatory in most applications. As with most relatively high speed/high output current Op Amps, best results are achieved when each supply line is decoupled with two capacitors; a small value ceramic capacitor ($\sim 0.01 \mu\text{F}$) placed very close to the supply lead in addition to a large value Tantalum or Aluminum ($> 4.7 \mu\text{F}$). The large capacitor can be shared by more than one device if necessary. The small ceramic capacitor maintains low supply impedance at high frequencies while the large capacitor will act as the charge "bucket" for fast load current spikes at the op amp output. The combination of these capacitors will provide supply decoupling and will help keep the op amp oscillation free under any load.

SIMILAR HIGH OUTPUT DEVICES

The LM7332 is a dual rail-to-rail amplifier with a slightly lower GBW capable of sinking and sourcing 100 mA. It is available in SOIC and MSOP packages.

The LM4562 is dual op amp with very low noise and 0.7 mV voltage offset.

The LME49870 and LME49860 are single and dual low noise amplifiers that can work from ± 22 volt supplies.

OTHER HIGH PERFORMANCE SOT-23 AMPLIFIERS

The LM7341 is a 4 MHz rail-to-rail input and output part that requires only 0.6 mA to operate, and can drive unlimited capacitive load. It has a voltage gain of 97 dB, a CMRR of 93 dB, and a PSRR of 104 dB.

The LM6211 is a 20 MHz part with CMOS input, which runs on ± 12 volt or 24 volt single supplies. It has rail-to-rail output and low noise.

The LM7121 has a gain bandwidth of 235 MHz.

Detailed information on these parts can be found at www.national.com.

Physical Dimensions inches (millimeters) unless otherwise noted

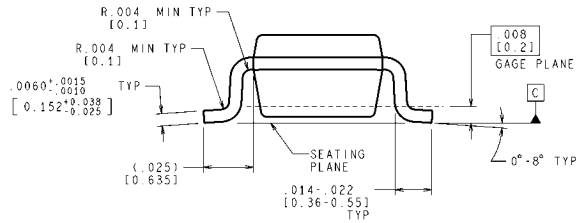
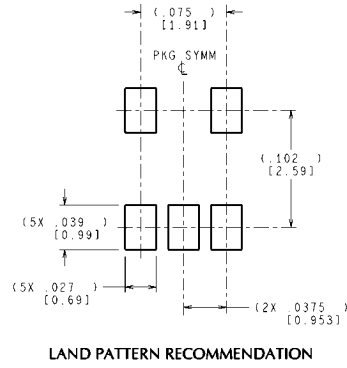
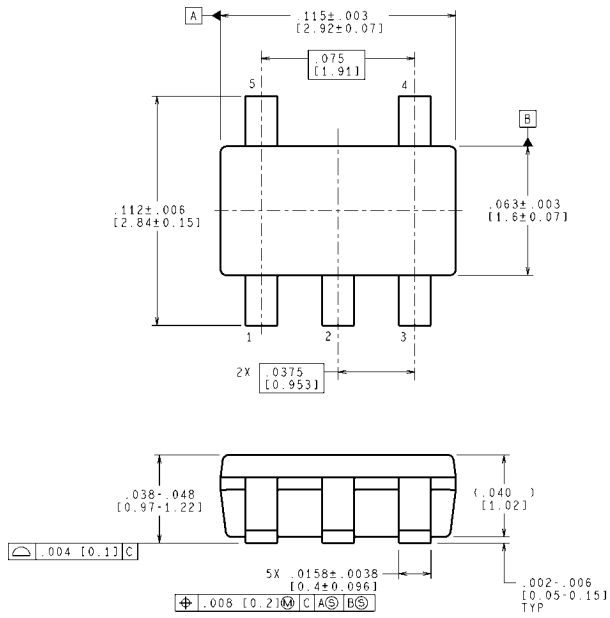

CONTROLLING DIMENSION IS INCH
VALUES IN [] ARE MILLIMETERS
DIMENSIONS IN () FOR REFERENCE ONLY

MF05A (Rev C)

5-Pin SOT-23
NS Package Number MF05A

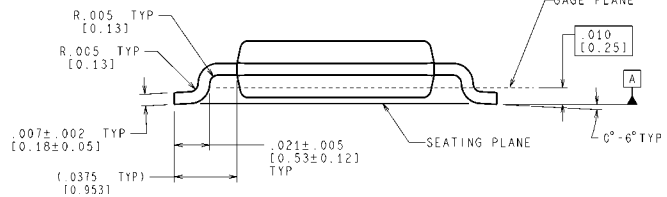
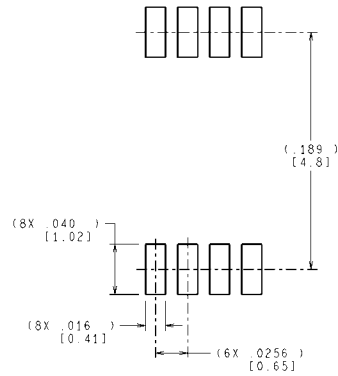
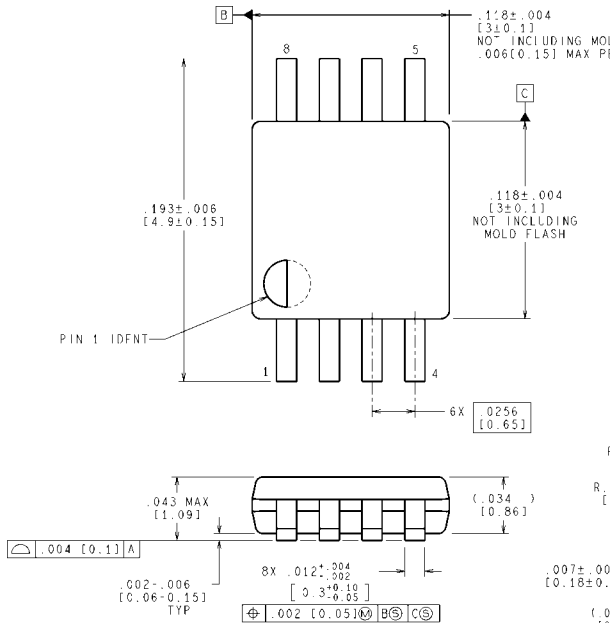

CONTROLLING DIMENSION IS INCH
VALUES IN [] ARE MILLIMETERS

MUA08A (Rev F)

8-Pin MSOP
NS Package Number MUA08A

Notes

Notes

For more National Semiconductor product information and proven design tools, visit the following Web sites at:

Products		Design Support	
Amplifiers	www.national.com/amplifiers	WEBENCH	www.national.com/webench
Audio	www.national.com/audio	Analog University	www.national.com/AU
Clock Conditioners	www.national.com/timing	App Notes	www.national.com/appnotes
Data Converters	www.national.com/adc	Distributors	www.national.com/contacts
Displays	www.national.com/displays	Green Compliance	www.national.com/quality/green
Ethernet	www.national.com/ethernet	Packaging	www.national.com/packaging
Interface	www.national.com/interface	Quality and Reliability	www.national.com/quality
LVDS	www.national.com/lvds	Reference Designs	www.national.com/refdesigns
Power Management	www.national.com/power	Feedback	www.national.com/feedback
Switching Regulators	www.national.com/switchers		
LDOs	www.national.com/lido		
LED Lighting	www.national.com/led		
PowerWise	www.national.com/powerwise		
Serial Digital Interface (SDI)	www.national.com/sdi		
Temperature Sensors	www.national.com/tempsensors		
Wireless (PLL/VCO)	www.national.com/wireless		

THE CONTENTS OF THIS DOCUMENT ARE PROVIDED IN CONNECTION WITH NATIONAL SEMICONDUCTOR CORPORATION ("NATIONAL") PRODUCTS. NATIONAL MAKES NO REPRESENTATIONS OR WARRANTIES WITH RESPECT TO THE ACCURACY OR COMPLETENESS OF THE CONTENTS OF THIS PUBLICATION AND RESERVES THE RIGHT TO MAKE CHANGES TO SPECIFICATIONS AND PRODUCT DESCRIPTIONS AT ANY TIME WITHOUT NOTICE. NO LICENSE, WHETHER EXPRESS, IMPLIED, ARISING BY ESTOPPEL OR OTHERWISE, TO ANY INTELLECTUAL PROPERTY RIGHTS IS GRANTED BY THIS DOCUMENT.

TESTING AND OTHER QUALITY CONTROLS ARE USED TO THE EXTENT NATIONAL DEEMS NECESSARY TO SUPPORT NATIONAL'S PRODUCT WARRANTY. EXCEPT WHERE MANDATED BY GOVERNMENT REQUIREMENTS, TESTING OF ALL PARAMETERS OF EACH PRODUCT IS NOT NECESSARILY PERFORMED. NATIONAL ASSUMES NO LIABILITY FOR APPLICATIONS ASSISTANCE OR BUYER PRODUCT DESIGN. BUYERS ARE RESPONSIBLE FOR THEIR PRODUCTS AND APPLICATIONS USING NATIONAL COMPONENTS. PRIOR TO USING OR DISTRIBUTING ANY PRODUCTS THAT INCLUDE NATIONAL COMPONENTS, BUYERS SHOULD PROVIDE ADEQUATE DESIGN, TESTING AND OPERATING SAFEGUARDS.

EXCEPT AS PROVIDED IN NATIONAL'S TERMS AND CONDITIONS OF SALE FOR SUCH PRODUCTS, NATIONAL ASSUMES NO LIABILITY WHATSOEVER, AND NATIONAL DISCLAIMS ANY EXPRESS OR IMPLIED WARRANTY RELATING TO THE SALE AND/OR USE OF NATIONAL PRODUCTS INCLUDING LIABILITY OR WARRANTIES RELATING TO FITNESS FOR A PARTICULAR PURPOSE, MERCHANTABILITY, OR INFRINGEMENT OF ANY PATENT, COPYRIGHT OR OTHER INTELLECTUAL PROPERTY RIGHT.

LIFE SUPPORT POLICY

NATIONAL'S PRODUCTS ARE NOT AUTHORIZED FOR USE AS CRITICAL COMPONENTS IN LIFE SUPPORT DEVICES OR SYSTEMS WITHOUT THE EXPRESS PRIOR WRITTEN APPROVAL OF THE CHIEF EXECUTIVE OFFICER AND GENERAL COUNSEL OF NATIONAL SEMICONDUCTOR CORPORATION. As used herein:

Life support devices or systems are devices which (a) are intended for surgical implant into the body, or (b) support or sustain life and whose failure to perform when properly used in accordance with instructions for use provided in the labeling can be reasonably expected to result in a significant injury to the user. A critical component is any component in a life support device or system whose failure to perform can be reasonably expected to cause the failure of the life support device or system or to affect its safety or effectiveness.

National Semiconductor and the National Semiconductor logo are registered trademarks of National Semiconductor Corporation. All other brand or product names may be trademarks or registered trademarks of their respective holders.

Copyright© 2008 National Semiconductor Corporation

For the most current product information visit us at www.national.com



National Semiconductor Americas Technical Support Center
 Email: support@nsc.com
 Tel: 1-800-272-9959

National Semiconductor Europe Technical Support Center
 Email: europe.support@nsc.com
 German Tel: +49 (0) 180 5010 771
 English Tel: +44 (0) 870 850 4288

National Semiconductor Asia Pacific Technical Support Center
 Email: ap.support@nsc.com

National Semiconductor Japan Technical Support Center
 Email: jpn.feedback@nsc.com