





| | | |
|----------------------|---|---|
| Approval |  |  |
| Electrical | | |
| Standard | UL | IEC |
| Rated voltage | 300V | 250V |
| Rated current | 10A | 15A |
| Wire range | 22-16AWG | 0.2-1.5mm ² |
| Withstanding voltage | AC2000V/1Min | |
| Mechanical | | |
| Ambient temperature | -40°C ~ +105 °C | |
| Strip length | 10mm | |
| Dimensions | | |
| Pitch | 5.08mm (.200") | |
| Poles | 1P-XXP | |
| Material | | |
| Housing | PA66,UL94V-0 | |
| Pin header | Brass, Tin plated | |
| Wire guard | Stainless steel | |



HOW TO ORDER :

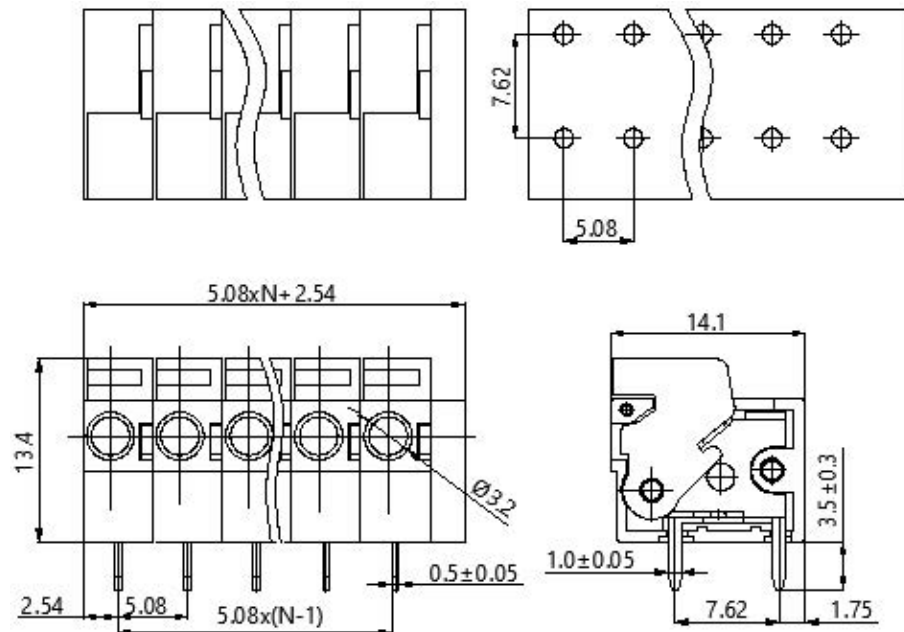
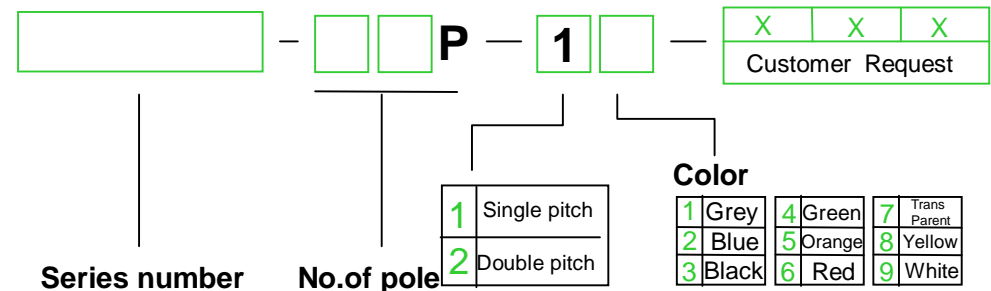
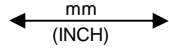

| | |
|---|---|
|  |  DEGSON ELECTRONICS CO., LTD. |
|  | NAME DG142R-5.08 |