

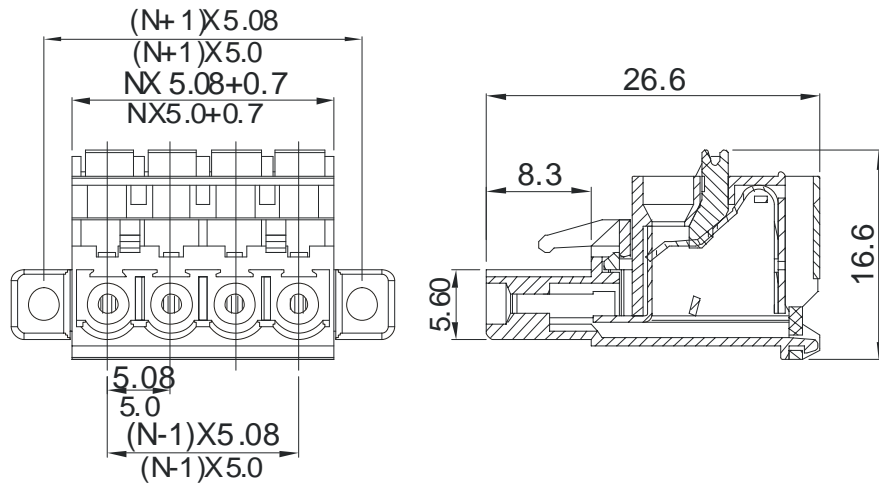



2EDGKDAM-5.0
2EDGKDAM-5.08

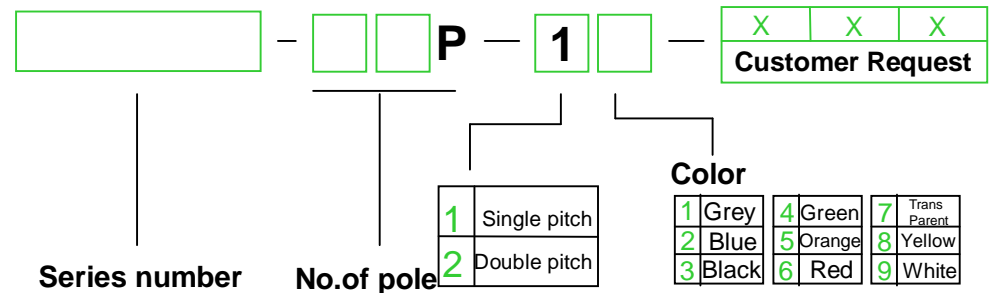

APPROVAL		
Electrical		
Standard	UL	IEC
Rated voltage	300V	320V
Rated current	10A	20A
Wire range	26-12AWG	2.5mm ²
Withstanding voltage	AC2500V/1Min	
Mechanical		
Ambient temperature	-40°C ~ +105 °C	
Strip length	10mm	
Dimensions		
Pitch	5.0mm(.197") 5.08mm(.200")	
Poles	2P-16P	
Material		
Housing	PA66,UL94 V-0	
Contact	Phosphor bronze	
Wire guard	Stainless steel	

HOW TO ORDER :

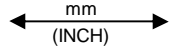

 mm (INCH)	 DEGSON ELECTRONICS CO., LTD.
 THROANGLE PROJECTION	NAME 2EDGKDAM-5.0 2EDGKDAM-5.08